



E-TENDER FOR

- 1. Construction of Amphitheater at Jagga Ki Bawari, NIA Jaipur**
- 2. Construction of Gazebo at NIA, Jagga Ki Bawari, Jaipur**
- 3. Construction of Watch Tower at NIA, Jagga Ki Bawari, Jaipur**

TENDER NO.: WAP/CMU-II/NIA/2025/09 Date: 28.01.2025

Project Management Consultant

WAPCOS LIMITED

76-C, INSTITUTIONAL AREA, SECTOR-18, GURGAON, HARYANA-122015

Table of Contents

Table of Contents	i	
Section-I: Notice Inviting Tender (NIT)	2	
Section-II - Instructions to Bidders (ITB)	6	
2.1	Introduction	6
2.2	Scope of Work	6
2.2.1	General	6
2.2.2	Reference to the Standard Codes of Practice	9
2.2.3	Dimensions	9
2.3	Period of Completion	9
2.4	Eligible Bidders	9
2.4.1	Work Experience	9
2.4.2	Certificates of Subsidiary/Group Companies/ Parental Company	10
2.4.3	Financial Strength	11
2.5	Site Location	11
2.6	Cost of Bidding	11
2.7	Tender Documents	12
2.8	Clarification of Bid Documents and Pre-Bid Meeting	12
2.9	Amendment of Bid Documents	12
2.10	Preparation of Bids	13
2.10.1	Language of Bid	13
2.10.2	Bidders Responsibility	13
2.10.3	Documents Required for Physical Submission of Technical Bid	13
2.10.4	QUALIFYING CRITERIA:	15
2.11	Financial Bid	18
2.12	Bid Price	18
2.13	Currency of Bid and Payment	18
2.14	Bid Validity Period	18
2.15	EMD and Tender Processing Fee	18
2.16	Bidding Condition	19
2.17	Format for Submittal	20
2.18	Power of Attorney	20
2.19	Submission of Bids	20
2.20	Broad Outline of Activities from Bidder's Perspective	21
2.21	Deadline for Submission of Bids	24
2.22	Modification and Withdrawal of Bids	24
2.23	Bidding Documents	24
2.24	Employer's Right to accept any Bid and to reject any or all Bids	24
2.25	Bid Opening and Evaluation	24
2.26	Shortfall Documents	25
2.27	Confidentiality of Bids	25
2.28	Clarification of Bids	25
2.29	Determination of Responsiveness	25
2.30	Corrections of Errors in Bids	26
2.31	Evaluation and Comparison of Bids	26
2.32	Award of Contract	26
2.33	Notification of Award	26
2.34	Signing of the Contract	27
2.35	Performance Security	27
2.36	Corrupt or Fraudulent Practices	28
Section-III - Annexures	30	
Annexure 1 - General Information	31	
Annexure 2 – EMD/Bid Security Declaration	32	
Annexure 3 - Form of Performance Security	33	
Annexure 4 - Form of Integrity Pact	35	
Annexure 5 - Declaration by the Bidder	42	
Annexure 6 - Details of Similar Works Executed During Last 07 Years	44	
Annexure 7 - Details of Similar Works Executed During Last 07 Years Meeting the Minimum Eligibility Criteria 2.4.1 i.e., Work Experience	45	
Annexure 8 - Preferred format for Work Experience Certificate from Clients	46	
Annexure 9 - Desired Site Organization Structure	47	
Annexure 9A - Undertaking for Manpower Deployment	48	
Annexure 10 - Time Schedule	49	

Annexure 11 - Financial Information - Turnover	50
Annexure 12 - Financial Information – Profit & Loss	51
Annexure 13 - Form of Solvency Certificate	52
Annexure 14 - Format of no Deviation Certificate	53
Annexure 15 - Format for Financial Bid	54
Annexure 16 - Format for Financial Bid	56
Annexure 17- Advance Payment Bank Guarantee	57
Annexure 18- Undertaking Regarding Blacklisting / Non - Debarment	59
Annexure 19 - Format for Agreement	60
Annexure 20 - Format for Indenture for Secured Advances	62
Annexure 21 - Certificate/ Undertaking giving the percentage of local content	66
Annexure 22 - Undertaking as per Rule 144 (xi) in the General Financial Rules (GFRs), 2017	68
Section-IV - General Conditions of Contract	72
A. Definitions	72
B. Interpretation	74
C. Discrepancies and Adjustment of Errors	74
D. Sufficiency of Tender	75
E. Clauses of Contract:	75
Clause 1: Performance Security	75
Clause 1A: Recovery of Security Deposit	76
Clause 2: Compensation for Delay	76
Clause 3: When Contract can be Determined	77
Clause 4: Contractor Liable to Pay Compensation Even if Action not Taken under Clause 3	79
Clause 5: Time and Extension for Delay	80
Clause 6: Measurements of Work Done	83
Clause 7: Payment on Intermediate Certificate to be regarded as Advances	84
Clause 7A	85
Clause 8: Completion Certificate and Completion Plans	85
Statutory Approvals	85
Clause 8a: Completion Plans to be submitted by the Contractor	86
Clause 9: Payment of Final Bill	86
Clause 9A: Payment of Contractor’s Bills to Banks: Not applicable	86
Clause 10: Materials Supplied by the Employer: Not applicable	86
Clause 10A:	86
Clause 10B:	87
Clause 10C	89
Clause 10D: Materials Obtained During Excavation	89
Clause 11: Works to be executed in accordance with Specifications, Drawings, and Orders etc.	89
Clause 12: Deviations/ Variations: Extent	90
Clause 12A: Payments for Change of Scope (Variations):	90
Clause 13: Foreclosure of Contract due to Abandonment or Reduction in Scope of Work	91
Clause 14: Carrying out Part Work at Risk & Cost of Contractor	93
Clause 15: Suspension of Work	94
Clause 16: Action in case Work not done as per Specifications	95
Clause 17: Contractor Liable for Damages, Defects During Defect Liability Period	96
Clause 18: Contractor Supply Tools & Plants Etc.	96
Clause 18A: Recovery of Compensation Paid to Workmen	97
Clause 18B: Ensuring Payment and Amenities to Workers, if Contractor Fails	97
Clause 19: Labour Laws to be complied by Contractor	97
Clause 19A	98
Clause 19B: Payment of Wages	98
Clause 19C: Safety Provisions for Labour and Penalty on Default	99
Clause 19 D: Submission of Labour Chart by every fortnight	99
Clause 19 E: Health and Sanitary Arrangements for workers	100
Clause 19F: Maternity Benefit rules:	100
Clause 19G: Penalty for Non-Compliance for Labour Regulation	100
Clause 19H: Providing Hutments, W/S, S/I, Drainage, Sanitations etc. for workers	101
Clause 19I: Removal of incompetent Workers	102
Clause 19J: No part of building to be occupied- action on breach thereof	103
Clause 19K: Employment of Skilled/Semi-Skilled Workers	103
Clause 20: Minimum Wages act to be complied with	104
Clause 21: Work not to be Sublet/Action in Case of Insolvency	104
Clause 22: Sums payable by way of compensations	104

Clause 23: Changes in Firm's Constitution to be intimated	104
Clause 24: Works to be Under Directions of Engineer-in-Charge	105
Clause 24A: Life Cycle Cost	105
Clause 25: Settlement of Disputes & Arbitration Amicable Resolution and Mediation	105
Clause 26: Contractor Indemnify Employer against Patent Rights	107
Clause 27: Action where no Specifications are specified	107
Clause 28: Withholding and Lien in Respect of Sum Due from Contractor	108
Clause 29: Lien in Respect of Claims in Other Contracts	109
Clause 30: Water for Works	109
Clause 31: Levy/ Taxes Payable by Contractor	109
Clause 32: Conditions for Reimbursement of Levy/Taxes if Levied after Receipt of Tenders:	110
Clause 33: Termination of Contract on Death of Contractor	111
Clause 34: Compensation during Warlike Situation	111
Clause 35: Apprentices act Provisions to be complied with	112
Clause 36: Release of Security Deposit after Labour Clearance	112
Clause 37: Employer's Financial Arrangements	112
Clause 38: Early Warning	113
Clause 39: Identifying Defects	113
Clause 40: Correction of Defects	113
Clause 41: Uncorrected Defects	113
Clause 42: Payment Certificates	114
Clause 43: Time Compensation Events	114
Clause 44: Termination	114
Clause 45: Payment upon Termination	115
Clause 46: Release from Performance	115
Clause 47: Insurance of Works Etc.	115
Clause 48: Possession of the Site:	117
Clause 49: Contractor's Storage and Site Office	117
Clause 49A:	117
Clause 50: If Relative Working in WAPCOS then the Contractor not allowed to Tender	118
Clause 51: No Gazetted Engineer to Work as Contractor within one Year of Retirement	118
Clause 52: Environmental Mitigation Measures during Construction	118
Clause 53: Preference to make in India	124
Clause 54: Rule 144 (xi) in General Financial Rules (GFRs) 2017	124
Clause 55: Other Conditions	125
SECTION-V TECHNICAL SPECIFICATIONS	126
SECTION – VI SAFETY CODES	163
SECTION –VII SAFETY WITH SCAFFOLDING	168
SECTION – VIII MODEL RULES	173
SECTION - IX CONTRACTOR'S LABOUR REGULATIONS	178
APPENDIXES	184
APPENDIX-I	185
APPENDIX-II	186
APPENDIX-III	187
APPENDIX-IV	188
APPENDIX-V	189
APPENDIX-VI	190
APPENDIX-VII	191
APPENDIX-VIII	192
APPENDIX-IX	193
APPENDIX-X	194
APPENDIX-XI	195
APPENDIX-XII	196
APPENDIX-XIII	197
APPENDIX-XIV	198
APPENDIX-XV	199
APPENDIX - XVI	200
SECTION – X SCHEDULE OF QUANTITIES	202
SECTION – XI DRAWINGS	203

DISCLAIMER

WAPCOS Limited has prepared this document as Project Management Consultant (PMC) on behalf of National Institute of Ayurveda (NIA), Jaipur under Ministry of AYUSH, Government of India to give information on the Project to the interested Bidder. The information is provided to Bidders on the terms and conditions set out in this document and any other terms and conditions subject to which such information is provided.

The purpose of this document is to provide Bidders with information to assist the formulation of their bid. The information is not intended to be exhaustive. Bidders are required to make their own inquiries and respondents will be required to confirm in writing that they have done so and they do not rely solely on the information in the document.

The information is provided on the basis that it is non-binding on National Institute of Ayurveda, Ministry of Ayush or WAPCOS Limited, any of its authorities or agencies or subsidiaries or any of their respective officers, employees, agents or advisors.

National Institute of Ayurveda and WAPCOS Limited reserve the right to not proceed with the Project or to change the configuration of the Project, to alter the time table reflected in this document or to change the process or procedure to be applied. It also reserves the right to decline to discuss the Project further with any party submitting the Bid.

While WAPCOS Limited and National Institute of Ayurveda have taken due care in the preparation of the information contained herein and believe it to be accurate, neither National Institute of Ayurveda nor WAPCOS Limited, any of its authorities or agencies nor any of their respective officers, employees, agents or advisors gives any warranty or make any representations, express or implied as to the completeness or accuracy of the information contained in this document or any information which may be provided in association with it.

Section-I
Notice Inviting Tender (NIT)

Section-I: Notice Inviting Tender (NIT)

WAPCOS Limited, as a Project Management Consultant on behalf of National Institute of Ayurveda (NIA), Jaipur under Ministry of AYUSH, Government of India invites open online Percentage Rate (Single Percentage Basis) tender from experienced, competent and eligible Contractors in a two-envelope system for the below mentioned work:

Tender No.	WAP/CMU-II/NIA/Jaipur/2025/09
Tender Invitation date	28.01.2025
Name of Work	1. Construction of Amphitheater at Jagga Ki Bawari, NIA Jaipur 2. Construction of Gazebo at NIA, Jagga Ki Bawari, Jaipur 3. Construction of Watch Tower at NIA, Jagga Ki Bawari, Jaipur
Owner	National Institute of Ayurveda, Jaipur under Ministry of AYUSH, Government of India,
Joint Venture	Joint Ventures/ Consortia of firms shall not be allowed
Time limit for Completion of Work	9 Months from the date of commencement of work
Date of commence of Work:	The date of start of work shall be reckoned from the 15 th day of date of issue of Letter of Award
Brief Scope of Work	The scope of work for the construction projects at Jagga Ki Bawari, NIA Jaipur includes the preparation of sites and the construction of an amphitheatre, gazebo, and watch tower. The amphitheatre will involve excavation, tiered seating, a stage, pathways, and drainage, utility provisions like lighting and water supply, and landscaping. The gazebo will require site clearing, a roofed structure with columns and seating, landscaping, and utilities. The watch tower will include foundation work, an elevated structure with platforms and staircases, safety features such as guardrails and non-slip flooring, along with lighting and security provisions.
Estimated Cost	Rs 2,96,60,750/- (Excluding GST) Rs 3,49,99,685/- (Including GST)
Earnest Money Deposit (EMD) & Tender Processing Fee	Rs. 593215/- (Rupees Five Lakh Ninety Three Thousand Two Hundred Fifteen Only) (Refundable) in the form of Insurance Surety Bonds/ Account Payee Demand Draft/ Fixed Deposit Receipt/ Banker's Cheque or Payment through RTGS/ NEFT in favor of 'WAPCOS Limited' payable at Gurugram, Haryana. OR EMD is acceptable in the form RTGS/NEFT as per following bank details: Name of Bank: Indian Overseas Bank Bank Account Number: 193502000000290 IFS Code: IOBA0001935 Branch Name: National Horticulture Board (NHB) Building, G-85, Industrial Area, Sector-18, Gurugram-122015, Haryana Rs. 5900/- (Rupees Five Thousand Nine Hundred Only) (including GST) as Tender Processing Fee in favour of WAPCOS Limited physically submitted
Solvency Certificate	Rs. 1.18 Crores (Rupees One Crore Eighteen Lakhs only) in original from a Scheduled Commercial Bank/Nationalized Bank approved by Reserve Bank of India (RBI). The Certificate should be issued between the publishing of NIT & last date of submission of Bids, including extensions if any and shall be addressed to the tendering authority quoting the name of the work as per format enclosed

Bid Validity	90 days from the date of submission of Bid
Tender Download start date	28.01.2025
Pre-Bid Meeting	05.02.2025 at 16:00 Hrs.
Venue of Pre-Bid Meeting	76, Institutional Area, Sector 18, Gurugram, Haryana 122015
Last date of EMD Submission	18.02.2025 up to 14:00 hrs.
Last date of Online Submission of Bid	18.02.2025 up to 14:00 hrs.
Last date of Physical submission of Documents	<p>18.02.2025 up to 14:00 hrs.</p> <ol style="list-style-type: none"> 1. Receipt of payment towards Tender Processing Fees deposited through RTGS/NEFT. 2. Notarized Power of Attorney/ Authorization Letter in case of Proprietor firm, to sign the Tender in original as per clause 2.18 of Instructions to Bidders. 3. Receipt of EMD submission through RTGS/NEFT along with annexure-2. 4. Solvency Certificate as per format enclosed in Annexure - 13
Date & Time of opening of Bid	19.02.2025 up to 14:30 hrs.

The bidding document can be downloaded from the website: www.wapcos.co.in, <https://etenders.gov.in/eprocure/app>. The tenders shall be uploaded on <https://etenders.gov.in/eprocure/app>. Further, any information or any issuance of corrigendum/addendum/amendment related to this tender will be available only on the website mentioned above and not be published elsewhere.

The technical bid shall be uploaded on the e-tendering portal on or before the last date of submission of tender. The Bidders must read all the terms and conditions of bidding document carefully and only submit the bid if eligible and in possession of all the documents required. The Bidder must ensure that the quoted rate shall be inclusive of all indirect costs such as (and not limited to) Logistics, Accommodation, TA/DA of personnel, Communication, Documentation, Transportation, Travel, Insurance, and other necessary and relevant taxes.

The purpose of this NIT is to provide interested parties with information to assist the preparation of their bid. While WAPCOS Limited has taken due care in the preparation of the information contained herein, and believe it to be complete and accurate, neither it nor any of its authorities or agencies nor any of its respective officers, employees, agents or advisors give any warranty or make any representations, expressed or implied as to the completeness or accuracy of the information contained in this document or any information which may be provided in association with it. The Bidders must read all the terms and conditions of bidding document carefully and only submit the bid if eligible and in possession of all the documents required.

In case the office of WAPCOS Limited, Gurgaon happens to be closed on the last date and time mentioned for any of the event such as opening of technical and financial bids, the said event shall take place on the next working day at the same time and venue.

sd/-
(Addl. Chief Engineer)
WAPCOS Limited

Section-II
Instructions to Bidders (ITB)

Section-II - Instructions to Bidders (ITB)**2.1 Introduction**

WAPCOS Limited, as Project Management Consultant on behalf of National Institute of Ayurveda (NIA), Jaipur under Ministry of AYUSH, Government of India invites percentage rate bid from interested Bidders for the following works herein after referred to as the Project:

- 1. CONSTRUCTION OF AMPHITHEATER AT JAGGA KI BAWARI, NIA JAIPUR**
- 2. CONSTRUCTION OF AMPHITHEATER AT JAGGA KI BAWARI, NIA JAIPUR**
- 3. CONSTRUCTION OF WATCH TOWER AT NIA, JAGGA KI BAWARI, JAIPUR**

The successful Bidder shall be expected to complete the works by the intended completion date specified in the Contract.

Throughout these bidding documents, the terms 'Bid' and 'Tender' and their derivatives (Bidder/ Supplier/Tenderer, Bid/ Tender, Bidding/ Tendering, etc.) are synonymous.

The Bidder shall provide a preliminary description of the proposed work method and schedules. The proposed methodology should include programme of construction backed with equipment planning and deployment duly supported with broad calculations and quality assurance procedures proposed to be adopted justifying their capability of execution and completion of work as per technical specifications, within stipulated period of completion.

2.2 Scope of Work**2.2.1 General**

The scope of work covered in this tender shall be as per the Schedule of Quantities, specifications, drawings, instructions, orders issued to the Contractor from time to time during the entire period of work. The broad items of work covered are as listed but not limited to the following:

Broadly the work shall comprises as listed but not limited to:

- Civil Work
- Electrical Work
- Plumbing Work
- HVAC Work
- Firefighting Work
- Furnishing Work etc

The Contractor before proceeding with the work shall verify all surveys, Geotechnical investigations, design and drawings.

The Contractor shall provide detailed construction drawings for approval before proceeding with the Construction work.

The Contractor shall submit monthly physical and financial progress report to the Employer.

The contractor before commencement of work will conduct confirmatory geo technical investigation to confirm the adequacy of the foundation provided especially in weak soils as per direction of the Engineer in Charge. Cost of the same will be deemed to be included in the price bid of the contractor and no separate payment shall be made on this account to the contractor.

NOTE:

- The Construction works area comes under Jagga Ki Bawari, Jaipur.
- The Contractor must aware about location of the proposed works, Surrounding local condition where works are to be constructed, Encroachment by local people and its consequence which may affect the progress of works. Accordingly, Contractor shall submit BID considering all these aspect and shall Quote the rates. Contractor shall not raise any extra/additional claim on these aspects.
- The contractor is required to deploy the resources at site and start the construction. No claim shall be entertained for idle labour, idle machinery, idle technical / non-technical staff, idle T&P and if any hindrance due to any reason.
- If any dispute/ hindrance may arise during construction, the contractor is not liable for any financial claim for damages due to such circumstances.
- The bidder shall be responsible right through the entire duration of the Project for execution of all works till commissioning and handing over of project complete with all respects and shall remove all defects, if any, developed during Defects Liability Period (DLP).
- No works, for which rates are not specifically mentioned in the priced schedule or quantities, shall be taken up without written permission of WAPCOS Limited. Rates of items not mentioned in the priced Schedule of Quantities shall be fixed by WAPCOS as provided in the corresponding clauses of the tender document.
- The work shall be executed as per the details in Schedule of Quantities and direction of Engineer-in Charge and shall be completed in all respect with full satisfaction of Engineer- in-Charge as per the Government guidelines, Indian standard codes & Manuals. The Bidder may assess the quantum of work before filling of tender.
- Contractor will also submit report on completed work along with drawings of completed (As-Built Drawings) work and including photographs of works.
- Contractor will take necessary approvals/clearance from the concerned departments before the start of work.
- The Contractor will submit the sample and test reports of prefab panel, paints, steel, cement, coarse sand etc. to the Engineer In-Charge for approval before starting the work.
- Any material used without prior approval shall be replaced by the Contractor immediately at his own cost. No payment in this regard shall be entertained.
- The contractor shall make his own arrangements for obtaining electric connection and water Connection/arrangement (if required).
- The Contractor shall dispose of all the dismantled materials, debris, garbage, waste outside of the campus of the works at his own cost after prior approval from Engineer in Charge and provide clear and clean site at the time of handing over the works.
- Contractor shall get the mix design prepared through a government engineering college or similar institutions and approved by the Engineer sufficiently in advance of commencing the work. No extra payment shall be made for excess cement quantities over minimum requirement as per IS code if any in the mix design.

Contractor is advised to visit the site to understand the Scope of Work clearly before quoting the rates for the works.

Getting No Objection Certificate from all related statutory authorities, if required.

The contractor shall also be responsible to obtain all statutory and local bodies' approvals, Accreditation, Clearances to occupy and commission the works done by them, if required as per law of local bodies/statutory bodies. Preparation of As-Built drawings, preparation of completion report including all repairs, if any, during Defect Liability Period as per Clause 2.3 of this Section.

The drawings for this work, which may be referred for tendering, provide a general idea only about the work to be performed under the scope of this Contract. These may not be the final drawings and may not indicate the full range of the work under the scope of this Contract.

The work shall be executed according to the drawings to be released as **“GOOD FOR CONSTRUCTION”** from time to time by the Engineer-in-Charge of the Employer and according to any additions/ modifications/ alterations/ deletions made from time to time, as required by any other drawings that would be issued to the Contractor progressively during execution of work. It shall be the responsibility of the Contractor to incorporate the changes that may be in the scope of work, envisaged at the time of tendering and as actually required to be executed.

The quantities of various items as mentioned in the **“SCHEDULE OF QUANTITIES”** are indicative only and may vary depending upon the actual requirement. The Schedule of Quantities is mentioned in the tender. The Contractor shall be bound to carry out and complete the stipulated work irrespective of the variation in individual items specified in the Schedule of Quantities. The variation of quantities shall be governed as per Clause-12 of Section IV.

All Drawings (except Bar Bending Schedule, Shop & Fabrication Drawings) for all works shall be supplied to the Contractor by the Employer in phased manner as the works progress. However, it shall be the duty and responsibility of the Contractor to bring to the notice of the Employer in writing as to any variation, discrepancy or any other changes required and to obtain revised drawings and designs and / or approval of the Employer in writing for the same.

One copy of contract documents including Drawings furnished to the Contractor shall be kept at the Site and the same shall at all reasonable times be available for inspection.

Contractor shall have to prepare the Shop and Fabrication Drawings free of cost for any of the items of work. Five copies of these Drawings each including for revision shall be submitted to the Employer. Before executing the item, Shop & Fabrication Drawings should be submitted to the Employer.

However, the final drawings shall be prepared and submitted to the Engineer-in-Charge for approval by the selected Contractor.

2.2.2 Reference to the Standard Codes of Practice

All Standards, Technical Specifications and Codes of practice referred to shall be latest editions including all applicable official amendments and revisions. The Contractor shall make available at site hard copies of all latest editions of relevant codes and CPWD specifications.

Wherever Indian Standards do not cover some particular aspects of design/ construction, relevant International Standards shall be referred to. The Contractor shall make available at site such standard codes of practice.

2.2.3 Dimensions

The levels, measurements and other information concerning the existing site as shown on the conceptual / layout drawings are believed to be correct, but the Bidders should verify the same for themselves and also examine the nature of the ground as no claim or allowance whatsoever shall be entertained on account of any errors or omissions and commissions in the levels or strata turning out different from what is shown on the drawings.

2.3 Period of Completion

The completion period shall be 9 months from the date of commencement of the work. The completion period is for the entire work of planning, execution, approvals, arrangement of materials, equipment, delivery at site including transportation, construction/ installation, testing, commissioning and handing over of the entire project to the satisfaction of the Engineer-in-charge.

The Warranty/Defect Liability Period shall commence from the date of issue of the Taking over Certificate or Completion Certificate whichever is later. Defects Liability Period for this Project is 12 Months. When under the Liability Period, it shall be the sole responsibility of the Contractor to any rectify defects in the executed works as deemed necessary by the Employer/Owner without any cost implications to Employer/ Owner.

2.4 Eligible Bidders

The interested Bidders should meet the following minimum eligibility criteria:

2.4.1 Work Experience

- i. Experience of having successfully completed similar works during the last 7 years ending last day of the month previous to the one in which bids are invited:

Three similar works each costing not less than 40% of cost put to tender.

OR

Two similar works each costing not less than 50% of cost put to tender.

OR

One similar work costing not less than 80% of cost put to tender.

Similar works means: Construction projects that involve creating public, recreational, or observational civil structures like Amphitheatre, Gazebo, Watch Tower etc.

Note:

- a) The past experience in similar nature of work and also for additional experience should be supported by certificates issued by the Client's

organization. The completion/ experience certificates, along with the supporting documents, shall be got verified from the issuing authority/ organizations prior to award of works. In case, the works/ certificates are not verified by the issuing authority, WAPCOS reserves the right to not consider for the award of works. For work experience of private sector, the completion certificates shall be supported with copies of corresponding TDS certificates.

- b) The value of executed works shall be brought to the current level by enhancing the actual value of work done at a simple rate of 7% per annum, calculated from the date of completion to the previous day of last day of submission of tenders.
- ii. The successful Bidder shall have to comply with provision of Contract labour (Regulation & Abolition) Act, 1970 and rules appended thereunder if applicable.

The value of the work done declared in Annexure-6 & Annexure-7 is to be without GST /Taxes. For the works, where the Taxes or GST is not clearly defined, the value of works shall be considered as including GST and GST as applicable shall be deducted to establish the value of work done.

The past experience in similar nature of work and also for additional experience should be supported by certificates issued by the Client's organization. The completion / experience certificates, along with the supporting documents, shall be got verified from the issuing authority / organizations prior to award of works. In case, the works / certificates are not verified by the issuing authority within a time period of 15 days (excluding holidays, Saturday & Sunday), WAPCOS reserves the right to not consider for the award of works.

- iii. The Bidder must not have been blacklisted by any Government agency or Public Sector Undertaking. A certificate shall be attached in this respect.
- iv. The interested Bidder shall be an Indian Registered Company under Companies Act 1956/2013, Proprietorship Firm/ Partnership Firm. Copy of Certificate of Incorporation/ Registration/ Partnership Deed Registration or any other relevant document, as applicable, shall be submitted along with a copy of address proof.
- v. The Bidder must possess valid License, GST Registration Certificate, PAN card and Company Registration Certificate, ISO registration.
- vi. The agency should have EPF registration. In case, EPF registration is not there, the agency should obtain EPF registration on allotment of work. In case of failure, WAPCOS reserves the right to deduct EPF & deposit as per EPF norms.
- vii. Joint Venture / consortia of firms or companies shall not be allowed to participate in the Bidding process.

2.4.2 Certificates of Subsidiary/Group Companies/ Parental Company

The companies/ firms, who intend to get qualified on the basis of experience of the subsidiary/Group Companies/parental company, shall not be considered and vice versa. In case of a Company/ firm, formed after merger and/ or acquisition of other companies/firms, past experience and other antecedents of the merged/ acquired

companies/firms will be considered for qualification of such Company/firm provided such Company/firm continues to own the requisite assets and resources of the merged/acquired companies/firms relevant to the claimed experience.

2.4.3 Financial Strength

- i. The average annual financial turnover on works during the immediate last three consecutive financial years, ending March, 2024 shall be at least 50% of cost put to tender. Audited Balance Sheet for 5 (five) years ending financial year 2023-24 are to be enclosed. The requisite certificates must be certified by statutory auditor of the firm/company. Any such certificate must carry the UDIN (Unique Document Identification Number). The tender evaluation sheet must carry the verification report of UDIN generated from ICAI Portal.
- ii. Bank Solvency Certificate issued from a Scheduled Commercial Bank/Nationalized Bank approved by Reserve Bank of India (RBI) should be at least 40% of cost put to tender. The Certificate should be issued between the publishing of NIT & last date of submission of Bids, including extensions if any and shall be addressed to the tendering authority quoting the name of the work. The certificate shall be submitted in original and the colour/ B&W copy/ scanned copy shall not be accepted. The certificate should carry name, designation & power of attorney of the bank official.
- iii. The net worth of the bidder should be positive during the last five financial year ending 2023-24. The requisite certificates must be certified by statutory auditor of the firm/company. Any such certificate must carry the UDIN (Unique Document Identification Number). The tender evaluation sheet must carry the verification report of UDIN generated from ICAI Portal.
- iv. The Bidder should not have incurred any loss (Profit after tax should be positive) in more than two years during the last Five financial years ending on the financial year 2023-24. The Bidders are required to submit detailed Balance Sheet of last five Financial Year (Audited) and also detailed pages of Profit & Loss Account (Audited) for last five years, the requisite certificates must be certified by statutory auditor of the firm/company. Any such certificate must carry the UDIN (Unique Document Identification Number). The tender evaluation sheet must carry the verification report of UDIN generated from ICAI Portal.
- v. The Bidder should be financially sound and should not have applied or be under corporate debt Restructuring on the last date of submission of Bid. The bidder shall submit the undertaking to this effect along with relevant documents.

2.5 Site Location

The address of the person concerned for conducting the site visit shall be as follows:
Site Location- **Dhanvantari Upvan, Jagga Ki Bawari, National Institute of Ayurveda (NIA)**

2.6 Cost of Bidding

The Bidder shall bear all the costs associated with the preparation and submission of Bid and the Employer in no case will be responsible or liable for those costs, regardless of the conduct or outcome of the Bidding process.

2.7 Tender Documents

The tender documents are as stated below and should be read in conjunction with any corrigendum/modification issued on these documents:

- Notice Inviting Tender (NIT)
- Instructions to Bidders (ITB)
- Annexures for Bid Submission
- General Conditions of Contract (GCC)
- Technical specifications
- Safety Codes
- Safety with Scaffolding
- Model Rules
- Contractor's Labour Regulations
- Appendixes
- Schedule of Quantities
- Drawings

The Bidder is expected to examine carefully the contents of all the above documents. Failure to comply with the requirement of the Bid submission will be at the Bidder's own risk. Bids which are not substantially responsive to the requirement of the bidding document shall be rejected.

2.8 Clarification of Bid Documents and Pre-Bid Meeting

Prospective Bidder requiring any clarification of the bidding documents may notify the Employer via email sent to: ckr@wapcos.co.in at least one working day prior to pre-bid meeting. The queries shall be discussed during the pre-bid meeting and the last date for submission of any further queries of Bidders shall be within two days from the date pre-bid meeting. Thereafter no further queries/clarifications shall be entertained. The Employer will reply to only those queries which received before the scheduled time as mentioned above via e-portal which are essentially required for submission of bids. The Employer will not reply to the queries which are not considered fit like replies of which can be implied/found in the NIT/Tender Documents or which are not relevant or in contravention to NIT/Tender Documents.

The **pre-bid meeting** shall be held at **D-14, WAPCOS Limited, Gurugram (Haryana)**, as per the schedule mentioned in the NIT. The text of the questions raised and the responses thereof will be uploaded on e-portal only.

While all efforts have been made to avoid errors in the drafting of the tender documents, the Bidder is advised to check the same carefully. No claim on account of any errors detected in the tender documents shall be entertained.

2.9 Amendment of Bid Documents

At any time prior to the deadline for submission of bids, the Employer may, for any reason (s), whether at their own initiative or in response to a clarification requested by a prospective Bidder, modify the Bidding Documents by the issuance of a corrigendum/ addendum. No modification of Bid shall be permissible after last date of submission, whatever may be the reason. The Employer may at their discretion may extend the deadline for submission of Tender/ Bid, if considered necessary.

Any corrigendum/ addendum thus issued shall be part of the bidding documents. Prospective Bidders shall download the same from the e-portal and submit along with the submission of Bid as token of acceptance.

2.10 Preparation of Bids

2.10.1 Language of Bid

The Bid prepared by the Bidder and all correspondence and documents relating to the Bid exchanged between the Bidder and Employer shall be written in the English language only.

2.10.2 Bidders Responsibility

- a) The Bidder is solely responsible for the details of their Bid and the preparation of bids. In no case shall the Employer be responsible for any part of the tender documents submitted by him. Any Site information given in this tender document is for guidance only. The Bidder is advised to visit and examine the Site of works and its surroundings at their cost and obtain for themselves on their own responsibility, all information that may be necessary for preparing the tender and entering into a Contract.
- b) Irrespective of whether or not the Bidders have attended the pre-bid meeting/ inspected the Site, they shall be deemed to have inspected the Site and its surroundings beforehand and taken into account all relevant factors pertaining to the Site and clarifications/ modifications/ additions given in Pre-Bid meeting or addendum issued as per Clause 2.8 of ITB, Section-II, in the preparation and submission of the Bid.
- c) The Bidder shall bear all costs associated with the preparation and submission of his Bid, and the Employer will in no case be responsible and liable for those costs.

2.10.3 Documents Required for Physical Submission of Technical Bid

The Bid submitted by the Bidder for consideration shall comprise of the following:

I. Technical Bid

The Technical Bid shall be uploaded with colored scanned copies of following documents. All the documents must be Serial wise as stated below and clearly marked page no. on each page.

The Technical Bids shall consist of two separate part (Offline - A1 & Online - A2) comprising the documents as mentioned below:

Offline – A1:

The bidder shall submit following Document offline in separate envelope clearly labeled as “OFFLINE DOCUMENTS” for the Work (Write Name of Work/Project as mentioned in NIT) along with Details of bidders Address, Phone, E-mail on Envelope.

1. Receipt of payment towards Tender Processing Fees deposited through RTGS/NEFT.
2. Notarized Power of Attorney/ Authorization Letter in case of Proprietor firm, to sign the Tender in original as per clause 2.18 of Instructions to Bidders.
3. Receipt of EMD submission through RTGS/NEFT along with Annexure-2

The documents submitted shall be examined first. Any bids not complying with the above-mentioned requirements shall not be evaluated further and shall be summarily rejected.

Online – A2:

This part of Technical Bid shall consist of the documents as mentioned below:

1. Letter of Transmittal.
2. Provident Fund Certificate, ESIC Certificate
3. GST Registration Certificate. If not registered till date of submission of bid, Bidder will give undertaking on their letter head stating that in case the work is awarded they will get registered in GST as per Govt. norms before submission of bills
4. Copy of PAN card.
5. Name, address, details of the organization, Name(s) of the Owner/Partners/ Promoters and Directors of the firm/ company as Annexure-1
6. Form of Integrity Pact as per format enclosed in Annexure-4
7. Declaration by Bidder as per format enclosed in Annexure-5
8. Details of similar type of works executed indicating value of works in each Contract with self-attested documentary evidence such as copy/ copies of completion Certificate(s) preferably as per Annexure-8, and testimonials indicating satisfactory performance of the work from reputed clients included in the list in last 7 years along with Letter of Intent(s)/ Work Order(s)/ Contract Agreement (s) from respective Owner(s)/ Client(s) mentioning name and nature of work(s), date(s) of commencement and value(s) of the job(s) executed during seven years as per format enclosed in Annexure-6
9. Details of similar type of work executed during last seven years indicating the value of works meeting the minimum eligibility criteria clause 2.4.1 Work Experience as per Annexure-7
10. Preferred format for Work Experience Certificate from Clients as per Annexure-8
11. Desired Site Organization Structure & Undertaking of the bidder to depute required manpower at site as per Annexure-9& 9A respectively.
12. Time Schedule to be provided by the Bidder enclosed as Annexure-10
13. Annual Turnover, Net worth and Audited Balance Sheets for Last 5 (Five) years ending on the financial year 2023-24 duly certified by statutory auditor carrying valid UDIN no. generated from ICAI Portal as per Annexure-11
14. Profit or Loss and Profit/Loss Statements for last 5 (five) years ending on the financial year 2023-24 as per Annexure-12 duly certified by statutory auditor carrying valid UDIN No generated from ICAI Portal
15. Solvency Certificate as per format enclosed in Annexure-13
16. Constitution & Legal Status along with attested copies of Deeds/Articles and Memorandum of Association etc. as Applicable
17. No Deviation Certificate as per Annexure-14
18. Undertaking regarding Blacklisting / Non-debarment as Annexure-18.
19. Certificate/Undertaking giving the percentage of local content at Annexure-21
20. Certificate/Undertaking as per Rule 144 (xi) in the General Financial Rules as per Annexure-22
21. Signed & Stamped tender document including Corrigendum & Addendum, if any

No information relating to financial terms of services should be included in the Technical Bid

2.10.4 QUALIFYING CRITERIA:

The intending bidders should only submit bid if he considers himself eligible and will be technically qualified, if have all the Documents as mentioned below in Table-1: “Documents for Technical Qualification”.

Table-1 shall also be considered as “CHECK LIST” for submission of documents. The bidder will upload all the required documents as per Table-1 on Online Portal and same shall be submitted Offline.

The “MANDATORY GUIDELINES” for “Uploading of Technical Bids” and “Submission of Offline Bids” are as below:

A. UPLOADING OF TECHNICAL BIDS

- 1) Bidder will arrange & prepare the all required documents as per Table no.-1.
- 2) After that Bidder will arrange all these documents serial wise as per order given in Table-1 i.e. S.N: a) to r) below
- 3) After that bidder will put continuous page number (without any break) on each page.
- 4) These page numbers shall be marked by bidder in “Check List” again each required documents
- 5) This numbered check list prepared by bidder shall be put on top of arranged numbered documents as per above Sno.2.
- 6) After that Authorized representative of bidder shall Sign & Stamp on each page of these arranged numbered documents.
- 7) The numbered Check List along with required Qualifying Documents arranged as per above Sno-1 to 6 shall be scanned in coloured by bidder and will be uploaded Online for ease of “Technical Evaluation”. If file size is increasing these documents may be split in parts, however serial/ order will be kept as per above Sno. 2 & 3 for ease of “Technical Evaluation”

Note: There is no need of add any other additional documents apart from the documents asked in Table-1, as additional documents will not be considered during Technical Evaluation

Note: If the bidder does not follow the above Guidelines, then the bid may be rejected by WAPCOS

Table -1: Documents for Technical Qualification**CHECK LIST****Name of Bidder** M/s**Name of Work** CONSTRUCTION OF HOSPITAL AT JAMWA RAMGARH, JAIPUR

S No	Particulars	Page Nos. (from – to)
1	Receipt of payment towards Tender Processing Fees deposited through RTGS/NEFT.	
2	Notarized Power of Attorney/ Authorization Letter in case of Proprietor firm, to sign the Tender in original as per clause 2.18 of Instructions to Bidders.	
3	Receipt of EMD submission through RTGS/NEFT along with Annexure-2	
4	Letter of Transmittal	
5	Provident Fund Certificate, ESIC Certificate	
6	GST Registration Certificate. If not registered till date of submission of bid, Bidder will give undertaking on their letter head stating that in case the work is awarded they will get registered in GST as per Govt. norms before submission of bills	
7	Copy of PAN card.	
8	Name, address, details of the organization, Name(s) of the Owner/Partners/ Promoters and Directors of the firm/ company as Annexure-1	
	Receipt of EMD submission through RTGS/NEFT along with Annexure-2	
9	Form of Integrity Pact as per format enclosed in Annexure-4	
10	Declaration by Bidder as per format enclosed in Annexure-5	
11	Details of similar type of works executed indicating value of works in each Contract with self-attested documentary evidence such as copy/ copies of completion Certificate(s) preferably as per Annexure-8, and testimonials indicating satisfactory performance of the work from reputed clients included in the list in last 7 years along with Letter of Intent(s)/ Work Order(s)/ Contract Agreement (s) from respective Owner(s)/ Client(s) mentioning name and nature of work(s), date(s) of commencement and value(s) of the job(s) executed during seven years as per format enclosed in Annexure-6	
12	Details of similar type of work executed during last seven years indicating the value of works meeting the minimum eligibility criteria clause 2.4.1 Work Experience as per Annexure-7	
13	Preferred format for Work Experience Certificate from Clients as per Annexure-8	
14	Desired Site Organization Structure & Undertaking of the bidder to depute required manpower at site as per Annexure-9 & 9A respectively.	
15	Time Schedule to be provided by the Bidder enclosed as Annexure-10	
16	Annual Turnover, Net worth and Audited Balance Sheets for Last 5 (Five) years ending on the financial year 2023-24 duly certified by statutory auditor carrying valid UDIN no. generated from ICAI Portal	

	as per Annexure-11	
17	Profit or Loss and Profit/Loss Statements for last 5 (five) years ending on the financial year 2023-24 as per Annexure-12 duly certified by statutory auditor carrying valid UDIN No generated from ICAI Portal	
18	Solvency Certificate as per format enclosed in Annexure-13 Constitution & Legal Status along with attested copies of Deeds/Articles and Memorandum of Association etc. as Applicable	
19	Constitution & Legal Status along with attested copies of Deeds/Articles and Memorandum of Association etc. as Applicable	
20	No Deviation Certificate as per Annexure-14	
21	Undertaking regarding Blacklisting / Non-debarment as Annexure-18	
22	Certificate/Undertaking giving the percentage of local content at Annexure-21	
23	Certificate/Undertaking as per Rule 144 (xi) in the General Financial Rules as per Annexure-22	
24	Signed & Stamped tender document including Corrigendum & Addendum, if any	

2.11 Financial Bid

The Financial Bid shall be submitted online only as per Annexure-15 & 16 along with Bid before last date & time of submission of Tender Document.

The Financial bid is to be submitted online only and directly submitted on CPPP Portal only.

Annexure-15 shall be filled in PDF & uploaded online only.

Annexure-16 shall only be filled in Excel format (not in PDF format) and also to be uploaded online only.

2.12 Bid Price

Unless stated otherwise in the Bidding Documents, the Bid Price shall be for the whole scope of work as described in ITB Clause-2.2 and shall include the followings:

- a) The total price quoted by the Bidder shall be firm during the performance of the Contract. Price quoted by the Bidder with any condition shall not be accepted and same is liable to be rejected.
- b) Prices quoted by the Bidder will include GST, all Materials, Tools & Plant, labour, supervision, profit; other levies together with all general risks, liabilities and obligations set out or implied in the contract, payments like PF, ESI, applicable Labour Cess, cost of insurance to this contract, all applicable tax liabilities, Income Tax & Surcharges, etc. There will be no variation in the Price quoted by the Bidder on any account. Any other taxes /cess as per Government directives shall be deducted from each bill paid to the Contractor, from time to time.
- c) The Contractor shall issue Tax Invoices to the Employer showing (i) Basic Amount (ii) GST Amount separately in each bill and the payment of GST amount shall be reimbursed to Contractor only after uploading of GST amount by Contractor on GST portal to avail input benefit of GST by the Employer.
- d) Anti-Profitteering Clause: Upon implementation of GST or any reduction in tax on account of anti-profitteering on supply of goods or services, the benefit of input tax credit shall be passed on to the employer by way of commensurate reduction in prices.
- e) In case of any law requires WAPCOS to pay tax on the contract price on reverse charge basis, the amount of tax deposited by WAPCOS would be considered as per Income tax act, GST Laws or any other law as applicable.
- f) The Employer shall be performing all its duties of deducting TDS and other deductions on payments made to Contractor as per applicable legislation in force on the date of submission of Bid or to be newly/amended introduced during the execution of the Contract.
- g) The Bidder shall keep the contents of his tender and rates quoted by him confidential.
- h) The Bidder shall utilize Indian labour, staff and materials to the maximum extent possible in execution of Works.

2.13 Currency of Bid and Payment

The payment shall be made in Indian Rupees only.

2.14 Bid Validity Period

Bids shall remain valid for acceptance for a period of 90 days (Ninety days) from the date of opening of Bids

The last date for submission of bid shall be reckoned from the last extension of bid, if any.

In exceptional circumstances, prior to expiry of the original bid validity period, the Employer may request the Bidder for a specified extension in the period of validity. The request and the responses thereto shall be made in writing or by e-mail. A Bidder may refuse the request. A Bidder agreeing to the request will not be required/nor permitted to modify his bid.

2.15 EMD and Tender Processing Fee

Rs. 593215/- (Rupees Five Lakh Ninety Three Thousand Two Hundred Fifteen Only) (Refundable) in the form of Insurance Surety Bonds/ Account Payee Demand Draft/ Fixed Deposit Receipt/ Banker's Cheque or Payment through RTGS/ NEFT in favor of 'WAPCOS Limited' payable at Gurugram, Haryana.
OR

EMD is acceptable in the form RTGS/NEFT as per following bank details:

Name of Bank: Indian Overseas Bank

Bank Account Number: 193502000000290

IFS Code: IOBA0001935

Branch Name: National Horticulture Board (NHB) Building, G-85, Industrial Area, Sector-18, Gurugram-122015, Haryana

Rs. 5900/- (Rupees Five Thousand Nine Hundred Only) (including GST) as Tender Processing Fee in favour of WAPCOS Limited **physically submitted**

2.15.1 No interest shall be paid to the bidder towards EMD, till it is released.

2.15.2 The EMD shall be payable to WAPCOS Limited without any condition(s), recourse or reservations

- i) The Bid will be rejected in case EMD is not submitted (In case EMD is not exempted)
- ii) The EMD of bidders other than the successful bidder will be returned not later than 45 (forty five) days after the expiry of bid validity.
- iii) The EMD of the successful bidder will be discharged after the bidder has furnished the required acceptable Performance Security.
- iv) The EMD shall be forfeited:
 - a) If a bidder withdraws the bid after bid opening during the period of validity;
 - b) In the case of a successful bidder; if the bidder fails to Sign the Agreement within the 15 days from the date of issue of LOA or fail to furnish the required performance security or fail to commence the work within the stipulated time period prescribed in the contract.

The unique transaction reference of RTGS/ NEFT shall have to be uploaded by the Tenderer in the e-tendering system by the prescribed date. The Additional Chief Engineer will get the earnest money verified from financial department based on the UTR number against each RTGS/ NEFT payment before the tenders are opened.

The Tender Processing Fee shall be submitted as per the details mentioned in the NIT. The bids without Tender Processing Fee and / or EMD shall be summarily rejected and shall not be evaluated further.

2.16 Bidding Condition

The Bidder shall submit offers which comply fully with the requirements of the Bid Document. Any deviation in submitted Bid for the Bidding Documents shall be liable for rejection.

2.17 Format for Submittal

Format for submittal of related information for Bid shall be as per the Annexures of Section-III and shall be strictly adhered to.

The Bid shall contain no overwriting, alternations or additions. Any corrections/cuttings should be signed by the tenderer.

All witnesses and sureties shall be persons of status and probity and their full names, occupations and addresses shall be written below their signatures.

2.18 Power of Attorney

- a) Power of Attorney duly notarized and on a stamp paper of an appropriate value, issued and signed by the member authorizing the person signing the tender documents to sign documents, make corrections/ modifications, to interact with the Employer and act as the contact person shall be submitted along with Technical Bid. The Power of Attorney shall be submitted in original and shall be specific to the Bid submission only. The Power of Attorney shall have been issued after the date of publishing of the tender.
- b) In case of proprietary firm, the Application shall be signed by the Proprietor with full name and name of the firm with his/ her current address.
- c) In case of a limited Company or Corporation, the Application shall be signed by an authorized person holding the Power of Attorney for signing the Application. A certified copy of the Power of Attorney shall accompany the Application.

2.19 Submission of Bids

This tender/ Bid shall follow a Single Stage Two Envelope Bid System i.e., Technical Bid and Financial Bid as given below.

a. Technical Bid

A complete set of Technical Bid per Clause 2.10.3 of this Section of bidding document shall be submitted physically at the address mentioned in NIT on or before the last date of submission of Bid, as well as online.

The Technical bid may be declared non-responsive/ invalid, if the Bid is not accompanied by the requisite documents as stipulated in clause 2.10.3 of this Section of bidding document.

The Technical Bid should not contain any financial information related to Financial Bid.

b. Financial Bid

The Financial Bid shall not include any Commercial or Technical conditions/ information. Financial offers shall be submitted as per prescribed format given in Annexure-15 & 16 of Section-III of Bid document on percentage basis. Financial Bid shall be uploaded on E-tender portal only as per given format of Excel uploaded on CPP portal. No hard copy of Financial Bid needs to be submitted.

- c. The Bidders are advised to submit complete details with their bids. In case of discrepancy between the documents physically submitted and documents

uploaded on e-tendering website, the Technical Bid Evaluation will be done on the basis of documents uploaded on e-tendering website by the Bidder. The information should be submitted in the prescribed proforma. Bids with incomplete/ambiguous information shall be summarily rejected.

2.20 Broad Outline of Activities from Bidder's Perspective

i) Submission of Bids

Online submission of Bid

The bidders are required to submit soft copies of their bids electronically on the CPP Portal, using valid Digital Signature Certificates. The instructions given below are meant to assist the bidders in registering on the CPP Portal, prepare their bids in accordance with the requirements and submitting their bids online on the CPP Portal. More information useful for submitting online bids on the CPP Portal may be obtained at: <https://etenders.gov.in/eprocure/app>.

ii) General

The Special Instructions (for e-Tendering) supplement 'Instruction to Bidders', as given in these Tender Documents. Submission of Online Bids is mandatory for this Tender.

iii) Broad Outline of Activities from Bidder's Perspective

REGISTRATION

1. Bidders are required to enroll on the e-Procurement module of the Central Public Procurement Portal (URL: <https://etenders.gov.in/eprocure/app>) by clicking on the link "Online bidder Enrollment" on the CPP Portal which is free of charge.
2. As part of the enrolment process, the bidders will be required to choose a unique username and assign a password for their accounts.
3. Bidders are advised to register their valid email address and mobile numbers as part of the registration process. These would be used for any communication from the CPP Portal.
4. Upon enrolment, the bidders will be required to register their valid Digital Signature Certificate (Class III Certificates with signing key usage) issued by any Certifying Authority recognized by CCA India (e.g., Sify/ nCode / eMudhra etc.), with their profile.
5. Only one valid DSC should be registered by a bidder. Please note that the bidders are responsible to ensure that they do not lend their DSCs to others which may lead to misuse.
6. Bidder then logs in to the site through the secured log-in by entering their user ID/ password and the password of the DSC / e-Token.

SEARCHING FOR TENDER DOCUMENTS

1. There are various search options built in the CPP Portal, to facilitate bidders to search active tenders by several parameters. These parameters could include Tender ID, Organization Name, Location, Date, Value, etc. There is also an option of advanced search for tenders, wherein the bidders may combine a number of search parameters such as Organization Name, Form of Contract, Location, Date, Other keywords etc. to search for a tender published on the CPP Portal.
2. Once the bidders have selected the tenders they are interested in, they may download the required documents / tender schedules. These tenders can be moved to the respective 'My

Tenders' folder. This would enable the CPP Portal to intimate the bidders through SMS / email in case there is any corrigendum issued to the tender document.

3. The bidder should make a note of the unique Tender ID assigned to each tender, in case they want to obtain any clarification / help from the Helpdesk.

PREPARATION OF BIDS

1. Bidder should take into account any corrigendum published on the tender document before submitting their bids.
2. Please go through the tender advertisement and the tender document carefully to understand the documents required to be submitted as part of the bid. Please note the number of covers in which the bid documents have to be submitted, the number of documents - including the names and content of each of the document that need to be submitted. Any deviations from these may lead to rejection of the bid.
3. Bidder, in advance, should get ready the bid documents to be submitted as indicated in the tender document / schedule and generally, they can be in PDF / XLS / RAR / DWF/JPG formats. Bid documents may be scanned with 100 dpi with black and white option which helps in reducing size of the scanned document.
4. To avoid the time and effort required in uploading the same set of standard documents which are required to be submitted as a part of every bid, a provision of uploading such standard documents (e.g., PAN card copy, annual reports, auditor certificates etc.) has been provided to the bidders. Bidders can use "My Space" or "Other Important Documents" area available to them to upload such documents. These documents may be directly submitted from the "My Space" area while submitting a bid, and need not be uploaded again and again. This will lead to a reduction in the time required for bid submission process.

Note: *My Documents space is only a repository given to the Bidders to ease the uploading process. If Bidder has uploaded his Documents in My Documents space, this does not automatically ensure these Documents being part of Technical Bid.*

SUBMISSION OF BIDS

1. Bidder should log into the site well in advance for bid submission so that they can upload the bid in time i.e., on or before the bid submission time. Bidder will be responsible for any delay due to other issues.
2. The bidder has to digitally sign and upload the required bid documents one by one as indicated in the tender document.
3. Bidder has to select the payment option as "offline" to pay the tender fee / EMD as applicable and enter details of the instrument.
4. Bidder should submit the EMD as per the instructions specified in the tender document. The receipt of submission should be posted/couriered/given along with Technical Bid in person to the concerned official, latest by the last date of bid submission or as specified in the tender documents. The details physically sent, should tally with the details available in the scanned copy and the data entered during bid submission time. Otherwise, the uploaded bid will be rejected.

5. Bidders are requested to note that they should necessarily submit their financial bids in the format provided and no other format is acceptable. If the price bid has been given as a standard BoQ format with the tender document, then the same is to be downloaded and to be filled by all the bidders. Bidders are required to download the BoQ file, open it and complete the white coloured (unprotected) cells with their respective financial quotes and other details (such as name of the bidder). No other cells should be changed. Once the details have been completed, the bidder should save it and submit it online, without changing the filename. If the BoQ file is found to be modified by the bidder, the bid will be rejected.
6. The server time (which is displayed on the bidders' dashboard) will be considered as the standard time for referencing the deadlines for submission of the bids by the bidders, opening of bids etc. The bidders should follow this time during bid submission.
7. All the documents being submitted by the bidders would be encrypted using PKI encryption techniques to ensure the secrecy of the data. The data entered cannot be viewed by unauthorized persons until the time of bid opening. The confidentiality of the bids is maintained using the secured Socket Layer 128-bit encryption technology. Data storage encryption of sensitive fields is done. Any bid document that is uploaded to the server is subjected to symmetric encryption using a system generated symmetric key. Further this key is subjected to asymmetric encryption using buyers/bid opener's public keys. Overall, the uploaded tender documents become readable only after the tender opening by the authorized bid openers.
8. The uploaded tender documents become readable only after the tender opening by the authorized bid openers.
9. Upon the successful and timely submission of bids (i.e., after Clicking "Freeze Bid Submission" in the portal), the portal will give a successful bid submission message & a bid summary will be displayed with the bid no. and the date & time of submission of the bid with all other relevant details.
10. The bid summary has to be printed and kept as an acknowledgement of the submission of the bid. This acknowledgement may be used as an entry pass for any bid opening meetings.

ASSISTANCE TO BIDDERS

1. Any queries relating to the tender document and the terms and conditions contained therein should be addressed to the Tender Inviting Authority for a tender or the relevant contact person indicated in the tender.
2. Any queries relating to the process of online bid submission or queries relating to CPP Portal in general may be directed to the 24x7 CPP Portal Helpdesk.
 - In case of any discrepancy, the online version of the bids uploaded on CPP Portal shall be considered as final. The clarifications, if sought from the bidder, and submitted by bidder through email / hard copy through courier shall be considered.
 - If the document submitted in response to the clarification sought is not found to be consistent with the bid, the bid shall be rejected.

- The Technical Bid shall be wrapped in an envelope addressed to Additional Chief Engineer, WAPCOS Ltd. Room No. D-14, Plot No. 76-C, Institutional Area, Sector-18, Gurugram, Haryana duly super scribing on top, tender number, name of work and time and last date for submission. The envelope should also bear the name and address of the Bidder. The financial bid is not be submitted in sealed cover physically. However, the same is to be uploaded online only.
- The contents of the Technical Bid and Financial Bid shall be as detailed under relevant clauses of ITB herein.
- No responsibility will be accepted by WAPCOS for the misplacement or premature opening of a tender/bid, not sealed or marked as per aforesaid instructions.
- The Bid should be submitted in the office of Sr. General Manager, CMU-II, WAPCOS Ltd. Room No. D-14, Plot No. 76-C, Institutional Area, Sector-18, Gurugram, Haryana.

2.21 Deadline for Submission of Bids

The Employer may, at their discretion, extend the deadline for submission of Bids by issuing an amendment, in which case all rights and obligations of the Employer and the Bidders previously subject to the original deadline shall thereafter be subject to the new deadline as extended.

2.22 Modification and Withdrawal of Bids

The Bidder may modify or withdraw his Bid prior to deadline for submission of Bid by giving modification or withdrawal notice in writing to Employer. Any modification shall be done in online bid along with the submission of modified physical bid.

The Bidder's modifications or notice of withdrawal shall be prepared, sealed and clearly marked as "Modification" or "Withdrawal" as appropriate and delivered prior to deadline for submission of Bid in accordance with ITB Clause-2.21.

No Bid will be modified after the deadline for submission of the Bid. Withdrawal of Bid between deadline for submission and expiry of Bid validity will result in suitable actions as per the conditions mentioned in the relevant clauses of contract.

2.23 Bidding Documents

Entire set of Bid Document shall be submitted after filling it wherever required & signing each page as a token of acceptance of all terms & conditions of the Bid.

2.24 Employer's Right to accept any Bid and to reject any or all Bids

The Employer reserves the right to accept or reject any Bid, and to annul the bidding process and reject all Bids, at any time prior to award of Contract, without thereby incurring any liability to the affected Bidder or Bidders or any obligation to inform the affected Bidder or Bidders of the grounds for the Employer's action.

2.25 Bid Opening and Evaluation

The Employer shall open the Bids as per the schedule. The Bidder will be at liberty to be present either in person or through an authorized representative at the time of opening of the Bid. The Employer will open the Bids in the presence of Bidders' representative who wish to attend on the time, date and venue as mentioned in NIT. The physical Bid shall also be opened on the day of Tender opening.

2.26 Shortfall Documents

The Employer may ask the Bidder for submission of additional documents, if required, in case of shortfall documents during the evaluation of the Bids. Request for documents and the response shall be in writing and no changes in the prices of the Bid shall be sought, offered or permitted. No modification of the Bid and any form of communication with the Employer or submission of any additional documents, not specifically asked for by the Employer, will be allowed and even when submitted, they will not be considered by the Employer.

2.27 Confidentiality of Bids

After the public opening of Bids, information relating to the examination, clarification, evaluation and comparison of Bids and recommendations concerning the Award of Contract shall not be disclosed to Bidders or other persons not officially concerned with such process.

Any effort by a Bidder to influence the Employer in the process of examination, clarification, evaluation and comparison of Bids, and in decisions concerning Award of Contract, may result in the rejection of their Bid.

2.28 Clarification of Bids

To assist in the examination, comparison and evaluation of Bid, the Employer may ask Bidders for clarification of the Bids, if any. But no change in price or substances of Bid will be sought, agreed or permitted. The request for clarification and its response shall invariably be in writing.

To assist in the examination, evaluation, and comparison of Bids, the Employer may, at their discretion, ask the lowest evaluated Responsive Bidder for clarification of his Bids. The request for clarification and the response shall be in writing or e-mail, but no change in the price or substance of the Bid shall be sought, offered, or permitted.

No Bidder shall contact the Employer on any matter relating to his Bid from the time of the Bid opening to the time the Contract is awarded. If the Bidder wishes to bring additional information to the notice of the Employer, it should do so in writing.

Any effort by the Bidder to influence the Employer in the Bid evaluation, bid comparison or Contract award decisions may result in the rejection of the Bidders' Bid.

2.29 Determination of Responsiveness

Prior to detailed evaluation of Bid it will be determined whether each Bid:

- i) Has been properly signed.
- ii) Is accompanied by required securities.

- iii) Is substantially responsive to the requirement of the Bidding document.
- iv) Provides necessary clarification or substance.

A Substantially Responsive Bid is one which conforms to all the terms, conditions & specifications without material deviation or reservation which

- i) Affects in any substantial way the quality or scope of the work.
- ii) Limits in any substantial way the scope of work
- iii) Is inconsistent with the Bidding document
- iv) Affects unfairly the competitive position of other Bidder(s).

Bids not found Substantially Responsive are liable to be rejected. Conditions if added by the Bidder, which have adverse bearing on the cost and scope of tendered work shall make the Tender/ Bid liable to disqualification.

2.30 Corrections of Errors in Bids

Bids will be checked for any arithmetical error and will be corrected by the Employer irrespective of concurrence of the Bidder. If the Bidder does not accept the corrected amount of Bid, his Bid will be rejected and the Bid Security will be forfeited.

2.31 Evaluation and Comparison of Bids

- a) The Employer shall first evaluate the Technical Bid in accordance with the requirements of the Bidding documents to ensure responsiveness of the Bids. A responsive bid shall only be considered as Technically Qualified. Bid(s) which are not found responsive shall be rejected.
- b) The Employer will evaluate and compare only the Bids determined to be substantially responsive.
- c) The evaluation of financial proposals by the Employer will take into account, in addition to the tender amounts, the following factors:
- d) Arithmetical errors corrected by the Employer in accordance with Clause 2.30 of this Section.
- e) Such other factors of administrative nature as the Employer may consider to have a potentially significant impact on Contract execution, price and payments, including the effect of items or rates that are unbalanced or unrealistically priced.
- f) Evaluation of Financial Bid will be based on percentage above/below or at par quoted by the Contractor.
- g) If the Financial Bids of lowest two Bidders are equal, then the Bidders shall be asked to resubmit the Financial Bid. No upward revision will be allowed.
- h) Any subsequent alteration in prices shall not be given any cognizance.

2.32 Award of Contract

Subject to Clause 2.33 of ITB, the Employer shall award the Contract to the Bidder whose tender has been determined to be substantially responsive, complete and in accordance with the tender documents, and whose total evaluated price for undertaking the entire project as detailed in tender documents is the lowest.

2.33 Notification of Award

Prior to the expiry of the period of Bid validity prescribed by the Employer or any extension thereof, the Employer shall notify the successful Bidder by email that his Bid has been accepted.

This “Letter of Award” shall contain the contract price payable to the successful Bidder in consideration of the execution, completion and maintenance of the Works by the successful Bidder as prescribed in the Contract (hereinafter and in the Conditions of Contract called “the Contract Price”). The notification of Award will constitute the part of the Contract agreement.

2.34 Signing of the Contract

Subsequent to receipt of the Letter of Award, on a date and time mutually agreed upon, or as specified in the Letter of Award, the successful Bidder or his authorized representative shall attend the office of Sr. General Manager (CMU-II), WAPCOS Limited, Plot No-76C, Institutional Area, Sector-18, Gurgaon-122015, Haryana for signing of the Contract Agreement. Failure on the part of the successful Bidder to comply with the above requirements will constitute sufficient grounds for the annulment of the Award and forfeiture of the Bid Security.

2.35 Performance Security

- a) Within 15 (Fifteen) days of receipt of the Letter of Award, but not later than the date of the signing of the Agreement, the successful Bidder shall deliver to the Employer a Performance Security in any of the forms given below for an amount equivalent to 3% of the Contract price:
 - a Bank Guarantee issued by a Scheduled Commercial Bank / Nationalized Bank approved by Reserve Bank of India (RBI) as per Annexure 3 of Bid document; or
 - a deposit receipt of a Scheduled Commercial Bank / Nationalized Bank approved by Reserve Bank of India (RBI) in favour of WAPCOS Limited payable at Delhi/ Gurgaon.
- b) The Bidder quoting below Minus (-) 10% of the estimated cost put to tender shall submit the additional performance guarantee of amount equal to the percentage of quoted amount by which the bidder has quoted below -10% of the estimated cost. For example: if the bidder quotes -10% of the estimated cost, then no additional performance guarantee is required. If the bidder quotes -11% of the estimated cost, then the bidder has to submit additional performance guarantee equal to 1% of the quoted amount. Similarly, if the bidder quotes -12% of the estimated cost, then the bidder has to submit additional performance guarantee equal to 2% of the quoted amount and so on. The validity of the Additional Performance Guarantee shall be same as the original performance guarantee. The Additional Performance Guarantee may be submitted in the same format of Performance Guarantee or this additional amount may be added to the original Performance Guarantee.
- c) The confirmation of the Bank Guarantee shall be sought from the issuing bank through Structured Financial Messaging System (SFMS), as per details given below:

Indian Overseas Bank
NHB, Gurgaon

Branch Code: 1935

IFSC code: IOBA0001935

Beneficiary: WAPCOS Limited

This shall also be applicable in respect of confirmation of any extension of the Bank Guarantee as and when required.

- d) The period for submission of the Performance Security can be extended upto 15 days by the competent authority upon written request received from the Bidder stating the reason for delays in procuring the Performance Security to the satisfaction of the Competent Authority.
- e) Failure of the successful Bidder to comply with the requirements of performance security shall constitute sufficient grounds for cancellation of the award.
- f) The Performance Security shall be valid until the date of 60 days after issuing of the Taking-over Certificate or Completion Certificate whichever is later. The performance guarantee shall be returned to the Contractor without any interest.

2.36 Corrupt or Fraudulent Practices

It is required that the Bidders /Contractor observe the highest standard of ethics during the procurement and execution of such contracts. In pursuance of this policy, it is defined, for the purposes of this provision, the terms set forth below as follows:

- “Corrupt practice” means the offering, giving, receiving or soliciting of anything of value to influence the action of a public official in the procurement process or in Contract execution
- “Fraudulent practice” means a misrepresentation of facts in order to influence a procurement process or the execution of a Contract to the detriment of the Employer and includes collusive practice among Bidders (prior to or after Bid submission) designed to establish Bid prices at artificial non-competitive levels and to deprive the Government of the benefits of free and open competition.

The Employer will reject a proposal for award if it determines that the Bidder recommended for award has engaged in corrupt or fraudulent practices in competing for the Contract in question and will declare the firm ineligible, either indefinitely or for a stated period of time, to be awarded a Contract.

**SECTION-III
ANNEXURES**

Section-III - Annexures

Letter of Transmittal/ Covering Letter

From:

To
The Dy. Chief Engineer
WAPCOS Limited, Gurugram

Subject: Submission of bids for the work of _____

Sir,

Having examined the details given in Bid document for the above work, I/ we hereby submit the relevant information.

1. I/ we hereby certify that all the statement made and information supplied in the enclosed Annexures (Annexure to___) and accompanying statement are true and correct.
2. I/we have furnished all information and details necessary for eligibility and have no further pertinent information to supply.
3. I/we submit the requisite certified solvency certificate and authorize the Employer to approach the Bank issuing the solvency certificate to confirm the correctness thereof. I/we also authorize Employer to approach individuals, our previous employers, firms and corporation to verify our competence and general reputation.
4. I/we submit the following certificates in support of our suitability, technical knowledge and capability for having successfully completed the following eligible similar works:

Name of work	Certificate from

Certificate:

It is certified that the information given in the enclosed eligibility Bid are correct. It is also certified that I/we shall be liable to be debarred, disqualified/cancellation of enlistment in case any information furnished by me/us found to be incorrect.

Enclosures:

Seal of Bidder

Date of submission:

Signature(s) of Bidder.

Annexure 1 - General Information

1.	Name of Contractor/Supplier	
2.	Address for correspondence	
3.	Official e-mail for communication	
4.	Contact Person: Telephone Nos.: Fax Nos.: Mobile:	
5.	Type of Organization:	
6.	Place and Year of Incorporation	
7.	Details of Registration of Proprietor/ Partners/ Directors with various Institutions	
8.	Name of Directors/ Partners in the organization and their status along with their qualifications.	
9.	Name(s) of the persons along with their qualification and designation, who is authorized to deal with Employer (Attach copy of Power of Attorney)	
10.	Details of Awards/Appreciations supported with document to be submitted.	
11.	Bank Details Name of the Bank: Account Number: IFSC Code: Name & Address of the Branch: MICR Code:	

Signature of Bidder with Seal

Annexure 2 – EMD/Bid Security Declaration

(To be given on Company Letter Head)

To,
 WAPCOS LIMITED,
 76-C, INSTITUTIONAL AREA,
 SECTOR-18, GURGAON, HARYANA-122015

Subject-Submission of Bid Security/ EMD

Reference- _____

Sir,

With reference to the tender under reference we would like to participate in the tender. As per the Instructions given in tender document, we are forwarding herewith the prescribed Earnest Money Deposit (EMD) as detailed below along with the duly filled tender documents.

DETAILS OF EMD SUBMITTED

1	Amount of EMD as per NIT	
2	Amount of EMD submitted through RTGS/NEFT	
3	Unique Transaction Reference of RTGS/NEFT	

(Copy of documentary evidence of having deposited EMD should be uploaded in the appropriate cover while submitting the tender)

SIGNATURE OF BIDDER
 WITHSEAL

Annexure 3 - Form of Performance Security

To
WAPCOS Limited,
76-C, Sector 18,
Gurgaon-122015

In consideration of _____ (Employer's name) (hereinafter referred to as "the Employer") which expression shall, unless repugnant to the context or meaning thereof include its successors, administrators and assigns) having awarded to _____ (Contractor's name & address) (hereinafter referred to as "the Contractor" which expression shall unless repugnant to the context or meaning thereof, include its successors, administrators, executors and assigns) a contract, by issue of Employer's Notification of Award No. _____ dt. _____ and the same having been unequivocally accepted by the Contractor, resulting into a contract valued at Rs. _____ (Rupees _____ only) for _____ (name of work) (hereinafter called "the contract") and the Contractor having agreed to provide a Contract Performance Guarantee for the faithful performance of the entire contract equivalent to Rs. _____ (Rupees _____ only) (3 % of the said value of the Contract to the Employer.

We, _____ (name & address with issue branch mail id of bank) (hereinafter referred to as "the Bank" which expression shall, unless repugnant to the context or meaning thereof, include its successors, administrators, executors and assigns) do hereby guarantee and undertake to pay the Employer, on demand any or, all monies payable by the Contractor to the extent of Rs. _____ (Rupees _____ only) as aforesaid at any time upto _____ without any demur, reservation, contest, recourse or protest and/or without any reference to the Contractor. Any such demand made by the Employer on the bank shall be conclusive and binding notwithstanding any difference between the Employer and the Contractor or any dispute pending before any Court, Tribunal, Arbitrator or any other authority. The Bank undertakes not to revoke this guarantee during its currency without previous consent of the Employer and further agrees that the guarantee herein contained shall continue to be enforceable till the Employer discharges this guarantee.

We the said Bank further agree that the guarantee herein contained shall remain in full force and effect during the period that would be taken for the performance of the said Contract and that it shall continue to be enforceable till all the dues of the Employer under or by virtue of the said contract have been fully paid and its claims satisfied or discharged or till the Employer certifies that the terms and conditions of the said Contract have been fully and properly carried out by the said Contractor and accordingly discharges the guarantee.

The Employer shall have the fullest liberty without affecting in any way the liability of the Bank under this guarantee, from, time to time to extend the time for performance of the Contract by the Contractor. The Employer shall have the fullest liberty without affecting this guarantee, to postpone from time to time the exercise of any powers vested in them or of any right which they might have against the Contractor and to exercise the same at any time in any manner and either to enforce or to forbear to enforce any covenants, contained or implied, in the Contract between the Employer and the Contractor or any other course or remedy or security available to the Employer. The bank shall not be released of its obligations under these presents by any exercise by the Employer of its liberty with reference to the matters aforesaid or any of them or by reason of any other act or forbearance or other acts of omission or commission on the part of the Employer or any

other indulgence shown by the Employer or by any other matter or thing whatsoever which under law would but for this provision, have the effect of relieving the Bank. The guarantee shall not be affected by a change in the constitution of the bank or of the employer.

The bank also agrees that the Employer at its option shall be entitled to enforce this Guarantee against the Bank as a principal debtor, in the first instance, without proceeding against the Contractor and notwithstanding any security or other guarantee that the Employer may have in relation to the Contractor's liabilities.

We The Said Bank do hereby declare that we have absolute and unconditional power to issue this guarantee in your favour under the Memorandum and Articles of Association or such other constitutional documents of the Bank and the undersigned have full power to execute this guarantee under the Power of Attorney/ Post Approval Authorization dated _____ of the bank granted to him / us by the Bank. We the said bank do hereby declare and undertake that your claim under the guarantee shall not be affected by any deficiency or other defect in the powers of the bank or its officials and the guarantee shall be deemed to have been issued as if the bank and its officials have all the powers and authorization to give this guarantee on behalf of the bank.

We the said bank do hereby certify the genuineness and appropriateness of the Stamp paper and stamp value used for issuing the guarantee. We the said bank do hereby declare and undertake that your claim under the guarantee shall not be affected by any deficiency or other defect in the stamp paper or its stamp value.

We the said bank do hereby declare that our payments hereunder shall be made to you, free and clear of and without and deduction, reduction on account of any reasons including any and all present and future taxes, levies, charges of withholding whatsoever imposed or collected with respect thereto.

Notwithstanding anything contained hereinabove our liability under this guarantee is restricted to Rs. _____ (Rupees _____ only) and it shall remain in force upto and including _____ and shall be extended from time to time for such period as may be desired by M/S WAPCOS Limited on whose behalf this bank guarantee has been given.

Notwithstanding anything contained herein

- i) our liability under this guarantee shall not exceed Rs. _____ (Rupees _____ only) ;
- ii) This bank guarantee shall be valid upto _____; and
- iii) our liability to make payment shall arise and we are liable to pay the guaranteed amount or any part thereof under this guarantee, only and only if you serve upon us a written claim or demand in terms of the guarantee on or before _____ (**indicate a date twelve months after validity of guarantee**).

Dated this _____ day of _____ at New Delhi.

(Signature)

For the Bank with seal

Name:

Designation:

Power of Attorney No:

Annexure 4 - Form of Integrity Pact

To,
WAPCOS Limited,
.....,
.....

Sub: Submission of Tender for the work of

Dear Sir,

I/We acknowledge that WAPCOS Limited is committed to follow the principles thereof as enumerated in the Integrity Agreement enclosed with the Tender/ Bid document.

I/We agree that the Notice Inviting Tender (NIT) is an invitation to offer made on the condition that I/We will sign the enclosed Integrity Agreement, which is an integral part of tender documents, failing which I/We will stand disqualified from the tendering process. I/We acknowledge that the making of the bid shall be regarded as an unconditional and absolute acceptance of this condition of the NIT.

I/We confirm acceptance and compliance with the Integrity Agreement in letter and spirit and further agree that execution of the said Integrity Agreement shall be separate and distinct from the main Contract, which will come into existence when Tender/ Bid is finally accepted by WAPCOS. I/ We acknowledge and accept the duration of the Integrity Agreement, which shall be in the line with Article 6 of the enclosed Integrity Agreement.

I/We acknowledge that in the event of my/our failure to sign and accept the Integrity Agreement, while submitting the Tender/ Bid, Employer shall have unqualified, absolute and unfettered right to disqualify the Tenderer/ Bidder and reject the Tender/Bid in accordance with terms and conditions of the Tender/ Bid.

Yours faithfully

(Duly authorized signatory of the Bidder)

Integrity Agreement

[To be submitted on Stamp paper of minimum Rs. 100 duly attested by Notary/Magistrate]

This Integrity Agreement is made at on this.....day of..... 2024

BETWEEN

WAPCOS Limited, Gurgaon hereinafter referred as “the Employer” (which expression shall unless repugnant to the meaning or context hereof include its successors and permitted assigns)

AND

..... (Name and Address of the Contractor), hereinafter referred to as the “Bidder/ Contractor” (which expression shall unless repugnant to the meaning or context hereof include its successors and permitted assigns)

(Details of duly authorized signatory)

Preamble

WHEREAS the Employer has floated the Tender (NIT No.) (hereinafter referred to as “Tender/Bid”) and intends to award, under laid down organizational procedure,Contractfor.....(Name of work) hereinafter referred to as the “Contract”.

AND WHEREAS the Employer values full compliance with all relevant laws of the land, rules, regulations, economic use of resources and of fairness/ transparency in its relation with its Bidders.

AND WHEREAS to meet the purpose aforesaid both the parties have agreed to enter into this Integrity Agreement (hereinafter referred to as “Integrity Pact” or “Pact”), the terms and conditions of which shall also be read as integral part and parcel of the Tender/ Bid documents and Contract between the parties.

NOW, THEREFORE, in consideration of mutual covenants contained in this Pact, the parties hereby agree as follows and this Pact witnesses as under:

Article 1: Commitment of the Employer

- (1) The Employer commits itself to take all measures necessary to prevent corruption and to observe the following principles:
 - (a) No employee of the Employer, personally or through any of his/ her family members, will in connection with the Tender, or the execution of the Contract, demand, take a promise for or accept, for self or third person, any material or immaterial benefit which the person is not legally entitled to.
 - (b) The Employer will, during the Tender process, treat all Bidder(s) with equity and reason. The Employer will, in particular, before and during the Tender process, provide to all Bidder(s) the same information and will not provide to any Bidder(s) confidential/ additional information through which the Bidder(s) could obtain an advantage in relation to the Tender process or the Contract execution.
 - (c) The Employer shall endeavor to exclude from the Tender process any person, whose conduct in the past has been of biased nature.
- (2) If the Employer obtains information on the conduct of any of its employees which is a criminal offence under the Indian Penal Code (IPC)/ Prevention of Corruption Act, 1988 (PC Act) or is in violation of the principles herein mentioned or if there be a substantive suspicion in this regard, the Employer will inform the Chief Vigilance Officer and in addition can also initiate disciplinary actions as per its internal laid down policies and procedures.

Article 2: Commitment of the Bidder(s)/ Contractor(s)

- (1) It is required that each Bidder/ Contractor (including their respective officers, employees and agents) adhere to the highest ethical standards, and report to the Employer all suspected acts of fraud or corruption or coercion or collusion of which it has knowledge or becomes aware, during the tendering process and throughout the negotiation or award of a Contract.
- (2) The Bidder(s)/ Contractor(s) commits himself to take all measures necessary to prevent corruption.

He commits himself to observe the following principles during his participation in the Tender process and during the Contract execution:

- (a) The Bidder(s)/ Contractor(s) will not, directly or through any other person or firm, offer, promise or give to any of the Employer's employees involved in the Tender process or execution of the Contract or to any third person any material or other benefit which he/ she is not legally entitled to, in order to obtain in exchange any advantage of any kind whatsoever during the Tender process or during the execution of the Contract.

- (b) The Bidder(s)/ Contractor(s) will not enter with other Bidder(s) into any undisclosed agreement or understanding, whether formal or informal. This applies in particular to prices, specifications, certifications, subsidiary contracts, submission or non-submission of bids or any other actions to restrict competitiveness or to cartelize in the bidding process.
- (c) The Bidder(s)/ Contractor(s) will not commit any offence under the relevant IPC/PC Act.

Further, the Bidder(s)/ Contractor(s) will not use improperly, (for the purpose of competition or personal gain), or pass on to others, any information or documents provided by the Employer as part of the business relationship, regarding plans, technical proposals and business details, including information contained or transmitted electronically.

- (d) The Bidder(s)/ Contractor(s) will, when presenting his Bid, disclose any and all payments he has made, is committed to or intends to make to agents, brokers or any other intermediaries in connection with the award of the Contract.
- (3) The Bidder(s)/ Contractor(s) will not instigate third persons to commit offences outlined above or be an accessory to such offences.
- (4) The Bidder(s)/ Contractor(s) will not, directly or through any other person or firm indulge in fraudulent practice means a willful misrepresentation or omission of facts or submission of fake/ forged documents in order to induce public official to act in reliance thereof, with the purpose of obtaining unjust advantage by or causing damage to justified interest of others and/ or to influence the procurement process to the detriment of the Employer interests.
- (5) The Bidder(s)/ Contractor(s) will not, directly or through any other person or firm use Coercive Practices (means the act of obtaining something, compelling an action or influencing a decision through intimidation, threat or the use of force directly or indirectly, where potential or actual injury may be fall upon a person, his/ her reputation or property to influence their participation in the tendering process).

Article3: Consequences of Breach

Without prejudice to any rights that may be available to the Employer under law or the Contractor its established policies and laid down procedures, the Employer shall have the following rights in case of breach of this Integrity Pact by the Bidder(s)/ Contractor(s) and the Bidder/ Contractor accepts and undertakes to respect and uphold the Employer's absolute right:

1. If the Bidder(s)/ Contractor(s), either before award or during execution of Contract has committed a transgression through a violation of Article 2 above or in any other form, such as to put his reliability or credibility in question, the Employer after giving 14 days' notice

to the Contractor shall have powers to disqualify the Bidder(s)/ Contractor(s) from the Tender process or terminate/determine the Contract, if already executed or exclude the Bidder/ Contractor from future Contract award processes. The imposition and duration of the exclusion will be determined by the severity of transgression and determined by the Employer. Such exclusion may be forever or for a limited period as decided by the Employer.

2. Forfeiture of EMD/Performance Security/Security Deposit: If the Employer has disqualified the Bidder(s) from the Tender process prior to the award of the Contract or terminated/determined the Contract or has accrued the right to terminate/determine the Contract according to Article 3(1), the Employer apart from exercising any legal rights that may have accrued to the Employer, may in its considered opinion forfeit the entire amount of Earnest Money Deposit, Performance Security and Security Deposit of the Bidder/ Contractor.
3. Criminal Liability: If the Employer obtains knowledge of conduct of a Bidder or Contractor, or of an employee or a representative or an associate of a Bidder or Contractor which constitutes corruption within the meaning of IPC Act, or if the Employer has substantive suspicion in this regard, the Employer will inform the same to law enforcing agencies for further investigation.

Article4: Previous Transgression

1. The Bidder declares that no previous transgressions occurred in the last 5 years with any other Company in any country confirming to the anticorruption approach or with Central Government or State Government or any other Central/State Public Sector Enterprises in India that could justify his exclusion from the Tender process.
2. If the Bidder makes incorrect statement on this subject, he can be disqualified from the Tender process or action can be taken for banning of business dealings/ holiday listing of the Bidder/ Contractor as deemed fit by the Employer.
3. If the Bidder/ Contractor can prove that he has resorted / recouped the damage caused by him and has installed a suitable corruption prevention system, the Employer may, at its own discretion, revoke the exclusion prematurely.

Article5: Equal Treatment of all Bidders/ Contractors/ Subcontractors

1. The Bidder(s)/ Contractor(s) undertake(s) to demand from all Subcontractors a commitment in conformity with this Integrity Pact. The Bidder/ Contractor shall be responsible for any violation(s) of the principles laid down in this agreement/Pact by any of its Subcontractors/sub- vendors.
2. The Employer will enter into Pacts on identical terms as this one with all Bidders and

Contractors.

3. The Employer will disqualify Bidders, who do not submit, the duly signed Pact between the Employer and the Bidder, along with the Tender or violate its provisions at any stage of the Tender process, from the Tender process.

Article6: Duration of the Pact

This Pact begins when both the parties have legally signed it. It expires for the Contractor 12 months after the completion of work under the Contractor till the continuation of defect liability period, whichever is more and for all other Bidders, till the Contract has been awarded.

If any claim is made/ lodged during the time, the same shall be binding and continue to be valid despite the lapse of this Pact as specified above, unless it is discharged/ determined by the Competent Authority or the Employer.

Article7: Other Provisions

1. This Pact is subject to Indian Law, place of performance and jurisdiction is the Headquarters of the Employer, who has floated the Tender.
2. Changes and supplements need to be made in writing. Side agreements have not been made.
3. If the Contractor is a partnership or a consortium, this Pact must be signed by all the partners or by one or more partner holding power of attorney signed by all partners and consortium members. In case of a Company, the Pact must be signed by a representative duly authorized by board resolution.
4. Should one or several provisions of this Pact turn out to be invalid; the remainder of this Pact remains valid. In this case, the parties will strive to come to an agreement to their original intentions.
5. It is agreed term and condition that any dispute or difference arising between the parties with regard to the terms of this Integrity Agreement / Pact, any action taken by the Employer in accordance with this Integrity Agreement/ Pact or interpretation thereof shall not be subject to arbitration.

Article 8: Legal and Prior Rights

All rights and remedies of the parties hereto shall be in addition to all the other legal rights and remedies belonging to such parties under the Contract and/ or law and the same shall be deemed to be cumulative and not alternative to such legal rights and remedies aforesaid. For

the sake of brevity, both the Parties agree that this Integrity Pact will have precedence over the Tender/ Contact documents with regard any of the provisions covered under this Integrity Pact.

IN WITNESS WHEREOF the parties have signed and executed this Integrity Pact at the place and date first above mentioned in the presence of following witnesses:

..... (For and on behalf of the Employer)

..... (For and on behalf of the Bidder/ Contractor)

WITNESSES:

1..... (Signature, name and address)

2..... (Signature, name and address)

Place:

Dated:

Annexure 5 - Declaration by the Bidder

[Affidavit on Non-Judicial Stamp Paper of Rs. 10/- duly attested by Notary/ Magistrate]

This is to certify that we, M/s _____ in submission of this offer confirm that:

We have inspected the site of work and have made myself/ ourselves fully acquainted with local conditions in and around the site of work. We have carefully gone through the Instructions to Bidders (ITB), General Conditions of Contract, Forms & Annexures, Technical Specifications, Schedule of Quantities, etc. to be submitted duly filled up & notarized in the form of Affidavit, where applicable, and time of completion (which is sacrosanct) of work of “_____”.

- i. Our tender is offered taking due consideration of all factors mentioned in tender documents.
- ii. We promise to abide by all the stipulations of the Contract documents and carry out and complete the work to the satisfaction of the Employer.
- iii. We also agree to procure Plants and Machineries at our cost required for the work. We also submit that we have Organizational Structure comprising adequate Technical Personnel in the line of requirement. We also agree to accomplish the job entrusted to us in the stipulated time laid out in document except situations not under our control.
- iv. We have not made any misleading or false representation in the forms, statement and attachments in proof of the qualification requirements;
- v. We do not have records of poor performance such as abandoning the work, not properly completing the Contract, inordinate delays in completion or financial failures etc.
- vi. Business has not been banned with us by any Central / State Government Department/Public Sector Undertaking or Enterprise of Central / State Government.
- vii. We are not barred/ blacklisted presently by any Department, Authority or body corporate under the Govt. of India or any state Govt.
- viii. We have submitted all the supporting documents and furnished the relevant details as per prescribed format.
- ix. We are financially sound and have not applied or be under corporate debt restructuring.
- x. List of Similar Works satisfying Qualification Criterion as indicated hereinafter, does not include any work which has been carried out by us through a Subcontractor on a back-to-back basis.

- xi. The information and documents submitted with the tender by us are correct and we are fully responsible for the correctness of the information and documents submitted by us.
- xii. We understand that in case any statement/information/document furnished by us or to be furnished by us in connection with this offer, is found to be incorrect or false, our business dealing will be banned.

SEAL, SIGNATURE & NAME OF THE BIDDER

(Authorized Person signing this document)

Annexure 6 - Details of Similar Works Executed During Last 07 Years

S No	Name of Work and its location	Name of Client	Date of Start	Date of Completion	Date of issue of Completion Certificate	Cost of the work on completion	Cost of the Work on current cost level	Litigation/ Arbitration cases pending/ in progress with details	Reference and Page No. of Documentary Proof
1.									
2.									
3.									
4.									
5.									
6.									

Certified that the Completion Certificates of above works are enclosed with the Tender Documents. Details mentioned in the above Form are as per Completion Certificates and have not been presumed. If any detail is not mentioned in the Work Completion Certificate, documentary proof of detail is to be submitted with the Completion Certificate.

Signature of Bidder with Seal

Annexure 7 - Details of Similar Works Executed During Last 07 Years Meeting the Minimum Eligibility Criteria 2.4.1 i.e., Work Experience

Sl. No.	Name of work and its location	Name of Client	Date of Start	Date of Completion	Date of issue of Completion Certificate	Cost of the work on completion	Cost of the Work on current cost level	Litigation/ Arbitration cases pending/ in progress with details	Reference and Page No. of Documentary Proof
1.									
2.									
3.									
4.									
5.									
6.									

Certified that the Completion Certificates of above works are enclosed with the Tender Documents. Details mentioned in the above Form are as per Completion Certificates and have not been presumed. If any detail is not mentioned in the Work Completion Certificate, documentary proof of detail is to be submitted with the Completion Certificate.

Signature of Bidder with Seal

Annexure 8 - Preferred format for Work Experience Certificate from Clients

Name of Contractor

1	Name of work/project & Location				
2	Name and Address of the				
3	Agreement Amount				
4	Estimated Cost				
4	Tender Amount				
5	Cost of the work on completion				
6	Date of start				
7	Stipulated date of completion.				
8	Actual date of completion/ likely date of completion				
9	Amount of compensation levied for delayed completion, if any				
10	Performance report	Very Good	Good	Fair	Poor
(a)	Quality of work	Very Good	Good	Fair	Poor
(b)	Resourcefulness	Very Good	Good	Fair	Poor
(c)	Financial soundness	Very Good	Good	Fair	Poor
(d)	Technical proficiency	Very Good	Good	Fair	Poor
(e)	General behavior	Very Good	Good	Fair	Poor

Date

Name & Designation of the Authority

Signature with Seal of the Bidder

Annexure 9 - Desired Site Organization Structure

S No	Designation	Qualification	Experience Level	Minimum No. Required
	A: Principal Technical Representative			
1	Project Head/ Project Manager	Graduate Engineer (Civil)	10 years	1
	Name	Qualification	Experience	
	B: Other Technical Representative			
2	Electrical Engineer	Graduate Engineer (Electrical)	5 years	1
	Name	Qualification	Experience	
3	Safety Engineer	Graduate Engineer (Safety)	5 years	1
	Name	Qualification	Experience	
4	Surveyor	Diploma Engineer	3 years	1
	Name	Qualification	Experience	

Annexure 9A - Undertaking for Manpower Deployment

[Affidavit on Non-Judicial Stamp Paper of Rs. 10/- duly attested by Notary/ Magistrate]

This is to certify that we, M/s _____, in submission of this offer confirm that:

We have carefully gone through the Instructions to Bidders (ITB) and all the documents, Forms & Annexures, etc. mentioned therein. (Which is sacrosanct) of work of “_____”.

- i. Our tender is offered taking due consideration of all factors including site requirements information and conditions of each and every proposed location of the upcoming Institute stated in the detailed Instructions to Bidders to execute the work up to the standards as laid out in Employer’s Requirements and other sections of ITB.
- ii. We agree to employ at our cost the adequate number of technical staff during the execution of this work depending upon the requirement of work. For this purpose, the numbers to be deployed, their qualification, experience as decided by WAPCOS shall be final and binding on us. We shall not be entitled for any extra payment in this regard.
- iii. WAPCOS shall have full power and without giving any reason to us, immediately to get removed any representative, staff and workmen or employees on account of misconduct negligence or incompetence or whose continued employment may in his opinion be undesirable. We shall not claim any compensation on this account.
- iv. We shall deploy additional manpower as deemed fit and required to complete the project within stipulated completion period, without any additional cost to the Employer.

SEAL, SIGNATURE & NAME OF THE BIDDER

(Authorized Person signing this document)

Annexure 10 - Time Schedule

(To be provided by the Bidder)

(Time Schedule of the project in the form of CPM, etc. detailing overall work program and a bar chart indicating the duration and timing of all major activities, keeping in view the deliverables)

Annexure 11 - Financial Information - Turnover

Financial Analysis: Details to be furnished duly supported by figures in balance sheet for last 5 years duly certified by the Chartered Accountant/ statutory auditor carrying valid UDIN no generated from ICAI Portal, as submitted by the applicant to the Income Tax Department

Years	Annual Turnover	Net Worth as on last date of the financial
2019-2020		
2020-2021		
2021-2022		
2022-2023		
2023-2024		
Average		

**Signature of Chartered Accountant
(with Seal)**

Signature of Bidder(s) (with Seal)

Annexure 12 - Financial Information – Profit & Loss

Profit/ Loss Statement: Details to be furnished duly supported by figures in profit/ loss statement sheets for last 5 years duly certified by the Chartered Accountant, as submitted by the applicant to the Income Tax Department

Years	PROFIT	LOSS
2019-2020		
2020-2021		
2021-2022		
2022-2023		
2023-2024		

**Signature of Chartered Accountant
(with Seal)**

Signature of Bidder(s) (with Seal)

Annexure 13 - Form of Solvency Certificate

(from a Scheduled Commercial Bank / Scheduled Commercial Bank/Nationalized Bank
approved by Reserve Bank of India (RBI))

To,

Additional Chief Engineer
WAPCOS Limited,
76-C, Sector 18, Gurgaon - 122015

Name of the work: **Tender for 1. Construction of Amphitheater at Jagga Ki Bawari, NIA Jaipur 2. Construction of Gazebo at NIA, Jagga Ki Bawari, Jaipur 3. Construction of Watch Tower at NIA, Jagga Ki Bawari, Jaipur**

This is to certify that to the best of our knowledge and information that M/s having marginally noted address, a customer of our Bank are/ is respectable and can be treated as good for any engagement upto a limit of Rs

(Rupees.....)

This certificate is issued without any Guarantee or responsibility on the Bank or any of the officers.

(Signature)
For the Bank with seal

Name:
Designation:
Power of Attorney No. :

NOTE:

1. Solvency certificate shall be on letterhead of the Bank.
2. The certificate shall be submitted in original and the colour/ B&W copy/ scanned copy shall not be accepted. The certificate should carry name, designation & power of attorney of the bank official.

Annexure 14 - Format of no Deviation Certificate**(To be submitted on Bidder's Letter Head)**

To

Additional Chief Engineer
WAPCOS Limited,
76-C, Sector 18, Gurgaon - 122015

Subject: No Deviation Certificate for ----- (name of Work /Project)

Dear Sir,

With reference to above this is to confirm that as per Tender conditions we have visited site before submission of our Offer and noted the job content and site condition etc. We also confirm that we have not changed/modified the above tender document and in case of observance of the same at any stage it shall be treated as null and void.

We hereby also confirm that we have not taken any deviation from Tender Clause together with other reference as enumerated in the above referred Notice Inviting Tender and we hereby convey our unconditional acceptance to all terms & conditions as stipulated in the Tender Document without any exception including any corrigendum / addendum and replies to pre-bid queries. In the event of observance of any deviation in any part of our offer at a later date whether implicit or explicit, the deviations shall stand null and void.

Yours faithfully,

(Signature, name and designation of the Authorized signatory)

Name and seal of Bidder

Date:

Place:

Annexure 15 - Format for Financial Bid

(To be submitted with Financial Bid)

(On the letter head of the Company)

To
The Additional Chief Engineer
WAPCOS Limited

Sub: Submission of Financial of Bid

Sir,

Having reviewed and fully understood all the requirements of Bid submission provided in the tender document, pertaining to **(Name of Work)** _____, I/ we hereby submit our Financial Proposal on percentage rate (Single Percentage Basis) as per scope of work and other terms & conditions mentioned in tender document. I/ we hereby also submit that

I/We have read and examined the all the Sections/Volumes of Bid document i.e. Notice Inviting Tender, Instruction to Bidders, General Conditions of Contract, Schedule of Quantities, Specifications, Drawings, etc. and all other contents in the bid document for the work of _____. I/we hereby also submit I/we have assessed the complete scope of work whether it is clearly mentioned in tender document or not and I/we shall not be paid any additional amount for the item(s) which are not mentioned in the tender document.

I/We hereby agree for the execution of the work within the specified time as mentioned in the bidding document.

I/We hereby submit that our percentage rate & quoted amount includes all associated costs with the project including any out of pocket / mobilization expenses, any other item(s) which are not mentioned in the tender document, buildings and other construction workers welfare cess, insurance, TDS, taxes, royalties, as applicable as per Government norms, in accordance with Clause 31 of GCC (Section-IV). We shall be reimbursed only the actual amount of GST on submission of proof of deposit of GST. It also includes the cost towards packing, forwarding, insurance, freight and delivery installation, testing and commissioning, etc.

I/we hereby agree that if at any time during the entire period of contract the Employer observes that I/we have not deposited the GST to the Government as per norms, the same shall be deducted from any amount payable to us.

I/We hereby submit that I/We have gone through the Scheduled of Quantities and agree that the rate provided against each item(s) of Scheduled of Quantities are correct and the Employer are not bound to share with us the detail analysis of the rate(s) of items. I/we agree that the payment shall be made as per rate provided in the Schedule of Quantities, considering the percentage quoted above or below and actual quantity executed at site as per the direction of Engineer-in-Charge.

I/We hereby agree that there may be certain differences in Description of item(s) provided in Scheduled of Quantities with Description of item(s) of Delhi Schedule of Rates (DSR)/CWC Textile manual, however, I/we agree to accept the rate provided in the Schedule of Quantities and execute the work as per the direction of Engineer-in-Charge.

I/We agree to keep the bid open for Ninety (90) days from the last date of submission of Bid, including extension, if any.

I/we understand that you are not bound to accept the lowest evaluated Bid or any other bid that you may receive.

If our Bid is accepted, we commit to submit a Performance Security in accordance with the Bidding Documents.

I/We agree to be bound by this offer if we are the selected Contractor for this project.

For and on behalf of:

Signature:

Name of Authorized Signatory:

Designation:

Annexure 16 - Format for Financial Bid

(To be submitted online only)

Note:

1. The Column Nos. 4 & 5 are mandatory to be filled by the bidders/tenderers. If these columns are left blank, the tender shall become invalid.
2. In Column No. 4, the option above or below is to be selected as the case may be.
3. In Column No. 5, the percentage (i.e. above or below, as the case may be) is to be filled. For the rates to be quoted 'At par' the percentage is to be quoted as Zero. However, only in such (i.e., for 'At par') a case any option of above or below may be selected from Column No. 4.
4. The amount in figures in column No.6 shall appear automatically corresponding to the percentage quoted in column No.4 & 5.
5. The tenderer is required to quote the percentage only "above" or "below" or intended 'At par' with the estimated cost to cover all the rates of item covered under the respective sub-heads.
6. The percentage shall be written in 2 (two) place of decimal only.

Annexure 17- Advance Payment Bank Guarantee

To,
M/s WAPCOS Limited,
76-C, Sector 18, Gurgaon-122015.

In consideration of WAPCOS LTD. (hereinafter referred to as "the Employer") which expression shall, unless repugnant to the context or meaning thereof include its successors, administrators and assigns) having awarded to _____ (Contractor's name) with its Registered /Head Office at _____ (hereinafter referred to as "the Contractor " which expression shall unless repugnant to the context or meaning thereof, include its successors, administrators, executors and assigns) a contract, by issue of Employer's Notification of Award No. _____ dt. _____ and the same having been unequivocally accepted by the Contractor, resulting into a contract valued _____ at _____ Rs. _____ (Rupees _____) _____ only) for _____ (hereinafter called " the contract") and the Employer having agreed to make an advance payment to the Contractor for performance of the above Contract amounting to Rs. _____ (Rupees _____ only) as an advance against bank guarantee to be furnished by the Contractor.

We, _____ (name & address with issue branch mail id of bank) having its Head Office at _____ (hereinafter referred to as "the Bank" which expression shall, unless repugnant to the context or meaning thereof, include its successors, administrators, executors and assigns) do hereby guarantee and undertake to pay the Employer immediately on demand any or, all monies payable by the Contractor to the extent of Rs. _____ (Rupees _____ only) as aforesaid at any time up to _____ without any demur, reservation, contest , recourse or protest and/or without any reference to the Contractor. Any such demand made by the Employer on the bank shall be conclusive and binding notwithstanding any difference between the Employer and the Contractor or any dispute pending before any Court, Tribunal, Arbitrator or any other authority. We agree that the Guarantee herein contained shall be irrevocable and shall continue to be enforceable till the Employer discharges this guarantee. We further agree that no change in the constitution of the Bank or of the Employer shall affect this guarantee.

The Employer shall have the fullest liberty without affecting in any way the liability of the Bank under this guarantee, from time to time, to vary the advance or to extend the time for performance of the Contract by the Contractor. The Employer shall have the fullest liberty without affecting this guarantee, to postpone from time to time the exercise of any powers vested in them or of any right which they might have against the Contractor and to exercise the same at any time in any manner, and either to enforce or to forbear to enforce any covenants, contained or implied, in the Contract between the Employer and the Contractor or any other course or remedy or security available to the Employer. The bank shall not be released of its obligations under these presents by any exercise by the Employer of its liberty with reference to the matters aforesaid or any of them or by reason of any other act or forbearance or other acts of omission or commission on the part of the Employer or any other indulgence shown by the Employer or by any other matter or thing whatsoever which under law would but for this provision, have the effect of relieving the Bank.

The bank also agrees that the Employer at its option shall be entitled to enforce this Guarantee against the Bank as a principal debtor, in the first instance without proceeding against the Contractor and notwithstanding any security or other guarantee that the Employer may have in relation to the Contractor's liabilities.

We The Said Bank do hereby declare that we have absolute and unconditional power to issue this guarantee in your favour under the Memorandum and Articles of Association or such other constitutional

documents of the Bank and the undersigned have full power to execute this guarantee under the Power of Attorney/ Post Approval Authorization dated _____ of the bank granted to him / us by the Bank. We the said bank do hereby declare and undertake that your claim under the guarantee shall not be affected by any deficiency or other defect in the powers of the bank or its officials and the guarantee shall be deemed to have been issued as if the bank and its officials have all the powers and authorization to give this guarantee on behalf of the bank.

We the said bank do hereby certify the genuineness and appropriateness of the Stamp paper and stamp value used for issuing the guarantee. We the said bank do hereby declare and undertake that your claim under the guarantee shall not be affected by any deficiency or other defect in the stamp paper or its stamp value.

We the said bank do hereby declare that our payments hereunder shall be made to you , free and clear of and without and deduction, reduction on account of any reasons including any and all present and future taxes, levies, charges of withholding whatsoever imposed or collected with respect thereto.

Notwithstanding anything contained hereinabove our liability under this guarantee is limited to Rs. _____ (Rupees _____ only) and it shall remain in force upto and including _____ and shall be extended from time to time for such period (not exceeding one year), as may be desired by M/S _____ on whose behalf this bank guarantee has been given.

Notwithstanding anything contained herein

- i) Our liability under this guarantee shall not exceed Rs. _____ (Rupees _____ only);
- ii) This bank guarantee shall be valid upto _____ and
- iii) our liability to make payment shall arise and we are liable to pay the guaranteed amount or any part thereof under this guarantee, only and only if you serve upon us a written claim or demand in terms of the guarantee on or before _____ **(indicate a date twelve months after the validity of the guarantee).**

Dated this _____ day of _____ at New Delhi.

WITNESS

(Signature)

(Signature)

(Name)

(Name)

(Official address)

(Designation with bank stamp)

(Signature)

Attorney as Power of Attorney

No. _____ Dt. _____

(Name)

(Official address)

Annexure 18- Undertaking Regarding Blacklisting / Non - Debarment

[To be submitted on Bidder's Letter Head]

To
WAPCOS Limited
76-C, Sector 18, Gurgaon-122015

This is to certify that we have taken the cognizance of Blacklisting Policy of WAPCOS Ltd. Further, we hereby Confirm and declare that we, M/s _____, is not blacklisted/ de-registered/ debarred by any Government Department/ Public Sector Undertaking/ Private Sector/ or any other agency for which we have Executed / Undertaken the works/ Services during the last 5 Years.

Date:

(Signature, name and designation
of the Authorized Signatory)

Place:

Name and seal of Bidder

Annexure 19 - Format for Agreement

[Note; This Proforma is included in the Bidding Documents only for the information of Bidders. Only the successful Bidder shall, in due course, be required to fill this Proforma.]

THIS AGREEMENT MADE the _____ day of _____ between WAPCOS Limited _____ of (Mailing address of WAPCOS Limited) _____ (hereinafter called “Employer” of the one part) and (Name of Contractor) _____ of (Mailing address of Contractor) _____ (hereinafter called “the Contractor” of the other part).

WHEREAS the WAPCOS Limited is desirous that “_____”. (Herein after referred to as “the Work”) should be executed by the Contractor AND WHEREAS by a Letter of Award No. _____ dated _____ WAPCOS Limited has accepted a Bid by the Contractor for the execution and completion of such Works AND WHEREAS the Contractor has agreed to undertake such work and furnish a performance security/bond pursuant to the Clause 2.35 of the section-II ‘Instructions to Bidders’

NOW THIS AGREEMENT WITNESSETH as follows;

1. In this Agreement words and expressions shall have the same meanings as are respectively assigned to them in the conditions of Contract hereinafter referred to.
2. The following documents shall be deemed to form and be read and construed as part of this Agreement, viz;
 - The Agreement
 - Letter of Award, notice to proceed with the works
 - Correspondence with the Bidders, Corrigendum/Amendments if any
 - Schedule of Quantities and Contractor's Financial Bid
 - Notice Inviting Tender (NIT)
 - Instructions to Bidders
 - General Conditions of Contract
 - Technical Specifications
 - Annexures
 - Drawings
 - Signed Copy of Documents submitted at the time of Bid Submission
 - Any other part of tender document as forming part of the Contract
3. The aforesaid documents shall be taken as complementary and mutually explanatory of one another.
4. In consideration of the payment to be made to the Contractor as mentioned in the NIT, the Contractor hereby covenants with the Employer to execute and complete the Works in conformity, in all respects, with the provisions of the Contract & NIT.
5. The Employer hereby covenants to pay the Contractor in consideration of the execution and completion of the Works and the remedying of defects therein the Contract Price or such other sum as may become payable under the provisions of the contract at the time and in the manner prescribed by the Contract.

IN WITNESS whereof the parties hereto have caused their respective common Seals to be hereunto affixed (or have hereunto set their respective hands and Seals) the day and year first above written.

SIGNED, SEALED AND DELIVERED

By the said

NAME _____

on behalf of the Contractor

in the presence of:

NAME _____

Address _____

By the said

NAME _____

on behalf of the Employer

in the presence of;

NAME _____

Address _____

Annexure 20 - Format for Indenture for Secured Advances

THIS INDENTURE made the..... day of20..... BETWEEN (hereinafter called the Contractor which expression shall where the context so admits or implies be deemed to include his executors administrators and assigns) of the one part and the WAPCOS (hereinafter called the WAPCOS which expression shall where the context so admits or implies be deemed to include his successors in office and assigns) of the other part.

WHEREAS by an agreement dated..... (hereinafter called the said agreement) the Contractor has agreed AND WHEREAS the Contractor has applied to the WAPCOS that he may be allowed advances on the security of materials absolutely belonging to him and brought by him to the site of the works the subject of the said agreement for use in the construction of such of the works as he has undertaken to execute at rates fixed for the finished work (inclusive of the cost of materials and labour and other charges) AND WHEREAS the WAPCOS has agreed to advance to the Contractor the sum of Rupees on the security of materials the quantities and other particulars of which are detailed in Accounts of Secured Advances attached to the Running Account Bill for the said works signed by the Contractor onand the WAPCOS has reserved to himself the option of making any further advance or advances on the security of other materials brought by the Contractor to the site of the said works. Now THIS INDENTURE WITNESSETH that in pursuance of the said agreement and in consideration of the sum of Rupeeson or before the execution of these presents paid to the Contractor by the WAPCOS (the receipt whereof the Contractor doth hereby acknowledge) and of such further advances (if any) as may be made to him as aforesaid the Contractor doth hereby covenant and agree with the WAPCOS and declare as follows: -

- (1) That the said sum of Rupeesso advanced by the WAPCOS to the Contractor as aforesaid and all or any further sum or sums advanced as aforesaid shall be employed by the Contractor in or towards expediting the execution of the said works and for no other purpose whatsoever.
- (2) That the materials detailed in the said Account of Secured Advances which have been offered to and accepted by the WAPCOS as security are absolutely the Contractor's own property and free from encumbrances of any kind and the contractor will not make any application for or receive a further advance on the security of materials which are not absolutely his own property and free from encumbrances of any kind and the Contractor indemnifies the WAPCOS against all claims to any materials in respect of which an advance has been made to him as aforesaid.

- (3) That the materials detailed in the said Account of Secured Advances and all other materials on the security of which any further advance or advances may hereafter be made as aforesaid (hereinafter called the said materials) shall be used by the Contractor solely in the execution of the said works in accordance with the directions of the Divisional Officer Division (hereinafter called the Divisional Officer) and in the term of the said agreement.
- (4) That the Contractor shall make at his own cost all necessary and adequate arrangements for the proper watch, safe custody and protection against all risks of the said materials and that until used in construction as aforesaid the said materials shall remain at the site of the said works in the Contractor's custody and on his own responsibility and shall at all times be open to inspection by the Divisional Officer or any officer authorised by him. In the event of the said materials or any part thereof being stolen, destroyed or damaged or becoming deteriorated in a greater degree than is due to reasonable use and wear thereof the Contractor will forthwith replace the same with other materials of like quality or repair and make good the same as required by the Divisional Officer.
- (5) That the said materials shall not on any account be removed from the site of the said works except with the written permission of the Divisional Officer or an officer authorized by him on that behalf.
- (6) That the advances shall be repayable in full when or before the Contractor receives payment from the WAPCOS of the price payable to him for the said works under the terms and provisions of the said agreement. Provided that if any intermediate payments are made to the Contractor on account of work done than on the occasion of each such payment the WAPCOS will be at liberty to make a recovery from the Contractor's bill for such payment by deducting there from the value of the said materials then actually used in the construction and in respect of which recovery has not been made previously, the value for this purpose being determined in respect of each description of materials at the rates at which the amounts of the advances made under these presents were calculated.
- (7) That if the Contractor shall at any time make any default in the performance or observance in any respect of any of the terms and provisions of the said agreement or of these presents the total amount of the advance or advances that may still be owing to the WAPCOS shall immediately on the happening of such default be repayable by the Contractor to the WAPCOS together with interest thereon at twelve per cent per annum from the date or respective dates of such advance or advances to the date of repayment and with all costs charges, damages and expenses incurred by the WAPCOS in or for the recovery thereof or the enforcement of this security or otherwise by reason of the default of the Contractor and the Contractor hereby covenants and agrees with the WAPCOS to repay and pay the same respectively to him accordingly.

(8) That the Contractor hereby charges all the said materials with the repayment to the WAPCOS of the said sum of Rupeesand any further sum or sums advanced as aforesaid and all costs charges, damages and expenses payable under these presents PROVIDED ALWAYS and it is hereby agreed and declared that notwithstanding anything in the said agreement and without prejudice to the powers contained therein if and whenever the covenant for payment and repayment herein before contained shall become enforceable and the money owing shall not be paid in accordance therewith the WAPCOS may at any time thereafter adopt all or any of the following courses as he may deem best :-

(a) Size and utilize the said materials or any part thereof in the completion of the said works on behalf of the Contractor in accordance with the provisions in that behalf contained in the said agreement debiting the Contractor with the actual cost of effecting such completion and the amount due in respect of advances under these presents and crediting the Contractor with the value of work done as if he had carried it out in accordance with the said agreement and at the rates thereby provided. If the balance is against the Contractor he is to pay same to the WAPCOS on demand.

b) Remove and sell by public auction the seized materials or any part thereof and out of the moneys arising from the sale retain all the sums aforesaid repayable or payable to the WAPCOS under these presents and pay over the surplus (if any) to the Contractor.

(c) Deduct all or any part of the moneys owing out of the security deposit or any sum due to the Contractor under the said agreement.

(9) That except in the event of such default on the part of the Contractor as aforesaid interest on the said advance shall not be payable.

(10) That in the event of any conflict between the provisions of these presents and the said agreement the provisions of these presents shall prevail and in the event of any dispute or difference arising over the construction or effect of these presents the settlement of which has not been herein before expressly provided for the same shall be finally resolved as per provisions of clause 25 of the General Conditions of Contract.

In witness whereof the saidandby the order and under the direction of the WAPCOS have hereunto set their respective hands the day and year first above written.

Signed, sealed and delivered by..... the said contractor in the presence of.....

Signature

Witness Name.....

Address

Signed by.....

by the order and direction of the WAPCOS in the presence of

Witness Name.....

Address

Signed by.....

Annexure 21 - Certificate/ Undertaking giving the percentage of local content

Name of Work: “Supply and Installation of Furniture” in New OPD Block at National Institute of Ayurveda, Jaipur”

We..... (Name of Firm) hereby confirm that we will follow the Make in India Policy and its Guidelines at the time of execution of subjected work. We have understood the provisions of Public Procurement (Preference to make in India) Local content Policy and will achieve the minimum local content target of 50%.

Date:

**(Signature, Name, Designation
of the Authorized signatory with Seal)**

Place:

PP-LC POLICY (PURCHASE PREFERENCE LINKED WITH LOCAL CONTENT)

PPLC Appendix

PROFORMA FOR SELF DECLARATION FOR LOCAL CONTENT

TENDER NO:

ISSUED BY: WAPCOS Limited (Procurement Authority)

I, the undersigned, do hereby declare, in my capacity as _____ of _____, the following:

- a) I have satisfied myself that the goods/ services/ works to be delivered in terms of the above-specified bid comply with the minimum local content requirements as specified in the bid document (refer Annexure Q).
- b) The local content has been calculated using the formula given in the “Appendix” contained in the Annexure Q referred above and the provisions as detailed in the PPLC amended policy attached therein.
- c) The Stipulated minimum threshold for Local content for the tendered items as _____% is hereby met and we qualify as Class I Local Supplier as defined under clause no. 2.5 of the PPLC amended Policy document.
- d) Local content for (product name) is certified as _____%, as calculated in terms of the PPLC amended policy. Note: If the bid is for more than one product, a schedule of the local content product-wise shall be attached.
- e) I also declare that Local Content certificate shall be submitted along with each invoice raised by us after the contract has been awarded and we will ensure that the percentage of minimum local content as per the Class of supplier shall be maintained during all stages of execution of contract.
- f) I accept that the Procurement Authority/ Institution have the right that the local content be verified in terms of the requirements of the said Policy.
- g) I understand that submission of incorrect data, or data that are not verifiable as described in the said Policy (PPLC amended policy), may result in the Procurement Authority imposing any or all of the remedies as provided under the Policy

Vendor:

Signature of the Authorised Signatory:

Name of the Authorised Signatory:

Date & Stamp:

Annexure 22 - Undertaking as per Rule 144 (xi) in the General Financial Rules (GFRs), 2017

UNDERTAKING

I have read the clause regarding restrictions on procurement from a bidder of a country which shares a land border with India; I hereby certify that this bidder is not from such a country or, if from such a country, has been registered with the Competent Authority. I hereby certify that this bidder fulfills all requirements in this regard and is eligible to be considered.

Date:

Place:

(Signature, name and designation of the Authorized signatory)

Name and seal of Bidder

FORMAT FOR FINANCIAL BID

To,
Deputy Chief Engineer
WAPCOS Limited
76-C, Institutional Area, Sector 18
Gurugram – 122015 (Haryana)

Subject: Submission of Financial Bid

Sir,

Having reviewed and fully understood all the requirements of Bid submission provided in the tender document, pertaining to _____, I/we hereby submit our Financial Proposal on percentage rate (Single Percentage Basis) as per scope of work and other terms & conditions mentioned in tender document.

I/We have read and examined the all the Sections/Volumes of Bid document i.e., Notice Inviting Tender, Instruction to Bidders, General Conditions of Contract, Schedule of Quantities, etc. Specifications, Drawings, and all other contents in the bid document for the work of _____. I/We hereby agree for the execution of the work within the specified time as mentioned in the bidding document.

I/We hereby submit that our percentage rate & quoted amount includes all associated costs with the project including any out of pocket / mobilization expenses, buildings and other construction workers welfare cess, insurance, TDS, taxes, royalties, as applicable as per Government norms, in accordance with Clause 22 of GCC (Section-IV). We shall be reimbursed only the actual amount of GST on submission of proof of deposit of GST. It also includes the cost towards packing, forwarding, insurance, freight and delivery installation, testing and commissioning, etc.

I/we hereby agree that if at any time during the entire period of contract the Employer observes that I/we have not deposited the GST to the Government as per norms, the same shall be deducted from any amount payable to us.

I/We hereby submit that I/We have gone through the Scheduled of Quantities and agree that the rate provided against each item(s) of Scheduled of Quantities are correct and the Employer are not bound to share with us the detail analysis of the rate(s) of non-scheduled/non-DSR items.

I/We agree to keep the bid open for Ninety (90) days from the last date of submission of Bid, including extension, if any.

I/we understand that you are not bound to accept the lowest evaluated Bid or any other bid that you may receive.

If our Bid is accepted, we commit to submit a Performance Security in accordance with the Bidding Documents.

I/We agree to be bound by this offer if we are the selected Architect/Consultant firm for this project.

(Signature, name and designation of the Authorized signatory)

Name and seal of Bidder

FINANCIAL BID
(To be submitted online only)

Section-IV
General Conditions of Contract (GCC)

Section-IV - General Conditions of Contract

A. Definitions

In the Contract, the following expressions shall, unless the context otherwise requires, have the meanings, hereby respectively assigned to them: -

1. **Applicable Law** means the laws and any other instruments having the force of law in India.
2. **“Employer/Project Management Consultant”** means WAPCOS Limited who proposes to get the works executed as mentioned in the Contract on behalf of National Institute of Ayurveda (NIA), Jaipur under Ministry of AYUSH, Government of India
3. **WAPCOS Limited** shall mean a company registered under the Indian Company Act 1956, with its registered office at New Delhi or its Administrative officers or its Engineer or other employees authorized to deal with any matter with which these persons are concerned and authorized on its behalf.
4. **“Principal Employer/Owner/Client/Competent Authority”** NIA, Jaipur who has appointed WAPCOS Ltd. as Project Management Consultant for the work of **“. Construction of Amphitheater at Jagga Ki Bawari, NIA Jaipur 2. Construction of Gazebo at NIA, Jagga Ki Bawari, Jaipur 3. Construction of Watch Tower at NIA, Jagga Ki Bawari, Jaipur”** to implement the project.
5. **“Project”** means **“1. CONSTRUCTION OF AMPHITHEATER AT JAGGA KI BAWARI, NIA JAIPUR, 3. CONSTRUCTION OF WATCH TOWER AT NIA, JAGGA KI BAWARI, JAIPUR”**
6. **‘Approval’** means approved by WAPCOS Limited on behalf of NIA, Jaipur in writing.
7. The **Contract** means the documents forming the tender and acceptance thereof and the formal agreement executed between the Employer on behalf of the NIA, JAIPUR and the Contractor/Supplier, together with the documents referred to therein including these conditions, the specifications, designs, drawings and instructions issued from time to time by the Engineer-in-Charge and all these documents taken together, shall be deemed to form one Contract and shall be complementary to one another.
8. **“Contract Price”** or Contract value means the sum indicated in the Letter of Award for the performance of the Services, in accordance with conditions of the Contract, and includes adjustments in accordance with the Contract.
9. The **“Bidder/Tenderer/Contractor/Supplier”** shall mean the individual, firm or company, whether incorporated or not, undertaking the works and shall include the legal personal representative of such individual or the persons composing such firm or company, or the successors of such firm or company and the permitted assignees of such individual, firm or company who are participating in Bidding process and will Execute the project after award of the Works as Contractor/Supplier.
10. **Engineer-in-Charge** means the Engineer as may be duly appointed and authorized in writing by the Employer to act as “Engineer-in-Charge” on its behalf for the purpose of the Contract, to perform the duty set forth in this General Condition of Contracts and other Contract documents.
11. **Estimated Cost** means estimated cost put to tender for inviting Financial Bid from the interested Bidders.
12. **Effective Date** means the date on which this Contract comes into force and effect pursuant.

13. **In writing** means communicated in written form with proof of receipt.
14. **Language** means all documents and correspondence in respect of this Contract shall be in English Language.
15. **Letter of Award (LOA)** shall mean the Employer's letter or notification conveying his acceptance of the tender subject to such conditions as may have been stated therein.
16. **Month** means English Calendar month 'Day' means a Calendar Day of 24 Hrs. each.
17. **"Bid" or "Bids" or "Tender"** shall mean the offer submitted by a Bidder in accordance with this document for the above project.
18. **Schedule of Rate** means Delhi Schedule of Rates.
19. **Works** or **Work** shall unless there be something either in the subject or context repugnant to such construction, be construed and taken to mean the works by or by virtue of the Contract contracted to be executed whether temporary or permanent, and whether original, altered, substituted or additional.
20. The words Tenderer, Bidder, Applicant, Contractor, and Supplier shall have the same meaning.
21. The words Project Management Consultant, Consultant shall have the same meaning.
22. The words WAPCOS Ltd., WAPCOS Limited, WAPCOS shall have the same meaning.
23. The words Engineer-in-Charge, Engineer shall have the same meaning.
24. **Shop Drawings:** Shop drawing are drawings or set of drawings produced by the Contractor, Supplier, Manufacturer, Subcontractor, or Fabricator.
25. The **Sites** or **Locations** shall mean the land/or other places on, into or through which work is to be executed under the Contract or any adjacent land, path or street through which work is to be executed under the Contract or any adjacent land, path or street which may be allotted or used for the purpose of carrying out the Contract.
26. The Contractor's Bid is the completed Bidding document submitted by the Bidder to the Employer and includes Technical and Financial bids;
27. A Defect is any part of the Works not completed in accordance with the Contract;
28. The Warranty (On site)/Defects Liability Period shall be 12 months and shall commence from the date of issue of the Taking over Certificate or Completion Certificate whichever is later.
29. Equipment is the Contractor's machinery and vehicles brought temporarily to the Site to construct the Works
30. Intended Completion Date is the date on which it is intended that the Contractor shall complete the Works. The Intended Completion Date shall be 9 months from the date of commencement of work. The Intended Completion Date may be revised only by the Employer by issuing an extension of time.
31. Materials are all supplies, including consumables, used by the Contractor for incorporation in the Works.
32. Plant is integral part of the Works, which is to have a mechanical, electrical, electronic or chemical or biological function.
33. Specification means the Specification of the works included in the Contract and any modification or addition made or approved by the Employer.
34. A Sub Contractor is a person or corporate body who has a Contract with the Contractor to carry out a part of the work in the Contract, which includes work on the Site.
35. Temporary Works are works designed, constructed, installed, and removed by the Contractors,

which are needed for construction or installation of the Works;

36. "Permanent Works" means the permanent works to be executed and maintained in accordance with the Contract
37. A Variation or Change in Scope is an instruction given by the Engineer-in-Charge, which varies and change the Scope of Works.

B. Interpretation

- I. In interpreting the Conditions of Contract, singular, some plural, male also means female or neuter, and the other way around. Headings have no significance. Words have their general meaning under the language of the Contract unless specifically defined. The Employer provides instructions clarifying queries about the Conditions of Contract.
- II. If sectional completion is specified in the Contract, references in the Conditions of Contract to the Works, the Completion Date, and the Intended Completion Date apply to any Section of the Works (other than references to the Completion Date and Intended Completion date for the whole of the Works).
- III. The documents forming the Contract shall be interpreted in the following order of priority:
 - The Agreement
 - Letter of Award, notice to proceed with the works
 - Correspondence with the Bidders, Corrigendum/Amendments if any
 - Schedule of Quantities and Contractor's Financial Bid
 - Notice Inviting Tender (NIT)
 - Instructions to Bidders
 - General Conditions of Contract
 - Technical Specifications
 - Annexures
 - Drawings
 - Signed Copy of Documents submitted at the time of Bid Submission
 - Any other part of tender document as forming part of the Contract

C. Discrepancies and Adjustment of Errors

- i) The several documents forming the Contract are to be taken as mutually explanatory of one another, detailed drawings being followed in preference to small scale drawing and figured dimensions in preference to scale.
- ii) In the case of discrepancy between the schedule of Quantities/Building Components, the Specifications and/ or the Drawings, the following order of preference shall be observed:
 - a) Description of Schedule of Quantities.
 - b) Particular Specification and Additional Condition, if any.
 - c) Drawings.
 - d) CPWD Specifications
 - e) Indian Standard Specifications of B.I.S

- iii) If there are varying or conflicting provisions made in any one document forming part of the Contract, the Engineer-in-Charge shall be the deciding authority with regard to the intention of the document and his decision shall be final and binding on the Contractor.
- iv) Any error in description, quantity or rate in Schedule of Quantities or any omission therefrom shall not vitiate the Contract or release the Contractor from the execution of the whole or any part of the works comprised therein according to drawings and specifications or from any of his obligations under the Contract.

D. Sufficiency of Tender

- i) The Contractor shall be deemed to have satisfied himself before bidding as to the correctness and sufficiency of his Bid for the Works and of the rates and prices stated in the Schedule of Quantities, which Bid rates and prices shall, except in-so far as it is otherwise provided in the Contract, cover all his obligations under the Contract, and all matters and things necessary for the proper execution/completion and maintenance of the works.
- ii) The Contractor shall, subject to the provisions of the Contract, and with due care and diligence, execute and maintain the Works and provide all labour, including the supervision thereof, materials, constructional plant and all other things, whether of a temporary or permanent nature, required in and for such execution and maintenance, so far as the necessity for providing the same is specified in or is reasonably to be inferred from the Contract.
- iii) The Contractor shall take full responsibility for the adequacy, stability and safety of all site operations and methods of construction, provided that the Contractor shall not be responsible, except as may be expressly provided in the Contract, for the design or specification of the Permanent Works, or for the design or specification of any Temporary Works prepared by the Engineer-in-Charge.
- iv) The Contractor shall promptly inform the Engineer-in-Charge of any error, omission, fault and other defect in the design of or specifications for the Works which are discovered when reviewing the Bidding Documents or in the process of execution of the Works.
- v) All instructions and orders given by the Engineer-in-Charge at Site are to be maintained in the Site Order Book and shall be taken to have been conveyed to the Contractor for his compliance.
- vi) Rectification of defects (if any) in Warranty/Defects Liability Period.
- vii) Clearance of site before Handing over of the facilities after fulfilling all the Obligations as per the Contract

E. Clauses of Contract:

Clause 1: Performance Security

- i) The Contractor shall submit an irrevocable Performance Security of 3% (Three percent) of the tendered amount in addition to other deposits mentioned elsewhere in the Contract for his proper performance of the Contract agreement, (not withstanding and/or without prejudice to

any other provisions in the Contract) within period and as per format as well as other conditions as specified in Clause 2.35 of Section-II.

- ii) The Engineer-in-Charge shall not make a claim under the performance Security except for amounts to which the Employer is entitled under the Contract (not withstanding and/or without prejudice to any other provisions in the Contract agreement) in the event of:
 - (a) Failure by the Contractor to extend the validity of the Performance Security as described herein above, in which event the Engineer-in-Charge may claim the full amount of the Performance Security.
 - (b) Failure by the Contractor to pay Employer any amount due, either as agreed by the Contractor or determined under any of the Clauses/Conditions of the agreement, within 30 days of the service of notice to this effect by Engineer-in-Charge.
- iii) In the event of the Contract being determined or rescinded under provision of any of the Clause/Condition of the agreement, the Performance Security shall stand forfeited in full and shall be absolutely at the disposal of the Employer.
- iv) The Performance Security shall be valid until the date of 60 days after issuing of the Taking over Certificate or Completion Certificate whichever is later. The performance guarantee shall be returned to the Contractor without any interest.

Clause 1A: Recovery of Security Deposit

- i) The Bidder whose tender may be accepted (hereinafter called the Contractor) shall permit Employer at the time of making any payment to him for work done under the Contract to deduct a sum at the rate of 5% of the gross amount of each running and final bill.
- ii) The security deposit as deducted above can be released against bank guarantee issued by a Scheduled Commercial Bank / Nationalized Bank approved by Reserve Bank of India (RBI), on its accumulations to a minimum of Rs. 10 lakhs subject to the condition that amount of such bank guarantee, except last one, shall not be less than Rs. 10 lakhs. The bank guarantee shall be valid until the date of 60 days after issuing of the Defect Liability Certificate.
- iii) The Security Deposit as deducted above shall be released within 60 days of successful completion of 12 months of Defect Liability Period as Certified by the Engineer-in-Charge or till the final bill has been prepared and passed whichever is later.

Clause 2: Compensation for Delay

If the contractor fails to maintain the required progress in terms of clause 5 or to complete the work and clear the site on or before the contract or justified extended date of completion as per clause 5 (excluding any extension under Clause 5.5) as well as any extension granted under clauses 12 and 15, he shall, without prejudice to any other right or remedy available under the law to the Government on account of such breach, pay as compensation the amount calculated at the rates stipulated below as may decide on the amount of accepted Tendered Value of the work for every completed day/ month (as determined) that the progress remains below that specified in Clause 5 or that the work remains incomplete.

(i) Compensation for delay of work

With maximum rate @ 1% (one percent) per week of delay to be computed on per day basis based on quantum of damage suffered due to stated delay on the part of Contractor.

Provided always that the total amount of compensation for delay to be paid under this condition shall not exceed 10 % (ten percent) of the accepted Tendered Value of work or of the accepted Tendered Value of the Sectional part of work for which a separate period of completion is originally given.

If the Engineer in Charge decides to give further extension of time allowing performance of work beyond the justified extended date, the contractor shall be liable to pay compensation for such extended period. If any variation in amount of contract takes place during such extended period beyond justified extended date and the contractor becomes entitled to additional time under clause 12, the net period for such variation shall be accounted for while deciding the period for levy of compensation. However, during such further extended period beyond the justified extended period, if any delay occurs by events under sub clause 5.2, the contractor shall be liable to pay compensation for such delay.

Provided that compensation during the progress of work before the justified extended date of completion for delay under this clause shall be for non-achievement of sectional completion or part handing over of work on stipulated/justified extended date for such part work or if delay affects any other works/services. This is without prejudice to right of action by the Engineer in Charge under clause 3 for delay in performance and claim of compensation under that clause.

In case action under clause 2 has not been finalized and the work has been determined under clause 3, the right of action under this clause shall remain post determination of contract but levy of compensation shall be for days the progress is behind the schedule on date of determination, as assessed by the Engineer-in-Charge, after due consideration of justified extension. The compensation for delay, if not decided before the determination of contract, shall be decided after of determination of contract.

The amount of compensation may be adjusted or set-off against any sum payable to the Contractor under this contract or any other securities of contractor deposited with the Employer.

Clause 3: When Contract can be Determined

Subject to other provisions contained in this clause, the Engineer-in-Charge may, without prejudice to his any other rights or remedy against the Contractor in respect of any delay, inferior workmanship, any claims for damages and/ or any other provisions of this Contract or otherwise, and whether the date of completion has or has not elapsed, by notice in writing absolutely determine the Contract in any of the following cases:

- i. If the Contractor having been given by the Engineer-in-Charge a notice in writing to rectify, reconstruct or replace any defective work or that the work is being performed in an inefficient or otherwise improper or un-workman like manner shall omit to comply with the requirement of such notice for a period of seven days thereafter.

- ii. If the Contractor has, without reasonable cause, suspended the progress of the work or has failed to proceed with the work with due diligence so that in the opinion of the Engineer-in-Charge (which shall be final and binding) he will be unable to secure completion of the work by the date for completion and continues to do so after a notice in writing of seven days from the Engineer-in-Charge.
- iii. If the Contractor fails to complete the work or section of work with individual date of completion on or before the stipulated or justified extended date, on or before such date of completion; and the Engineer-in-Charge without any prejudice to any other right or remedy under any other provision in the contract has given further reasonable time in a notice given in writing in that behalf as either mutually agreed or in absence of such mutual agreement by his own assessment making such time essence of contract and in the opinion of Engineer-in-Charge the Contractor will be unable to complete the same or does not complete the same within the period specified.
- iv. If the Contractor persistently neglects to carry out his obligations under the Contract and/or commits default in complying with any of the terms and conditions of the Contract and does not remedy it or take effective steps to remedy it within 7 days after a notice in writing is given to him in that behalf by the Engineer-in-Charge.
- v. If the Contractor shall offer or give or agree to give to any person in the Employer's service or to any other person on his behalf any gift or consideration of any kind as an inducement or reward for doing or forbearing to do or for having done or forborne to do any act in relation to the obtaining or execution of this or any other Contract for WAPCOS Limited.
- vi. If the Contractor shall enter into a Contract with the Employer in connection with which commission has been paid or agreed to be paid by him or to his knowledge, unless the particulars of any such commission and the terms of payment thereof have been previously disclosed in writing to the Engineer-in-Charge.
- vii. If the Contractor had secured the Contract with the Employer as a result of wrong tendering or other non-bonafide methods of competitive tendering or commits breach of Integrity Agreement.
- viii. If the Contractor being an individual, or if a firm, any partner thereof shall at any time be adjudged insolvent or have a receiving order or order for administration of his estate made against him or shall take any proceedings for liquidation or composition (other than a voluntary liquidation for the purpose of amalgamation or reconstruction) under any Insolvency Act for the time being in force or make any conveyance or assignment of his effects or composition or arrangement for the benefit of his creditors or purport so to do, or if any application be made under any Insolvency Act for the time being in force for the sequestration of his estate or if a trust deed be executed by him for benefit of his creditors.
- ix. If the Contractor being a company shall pass a resolution or the court shall make an order that the company shall be wound up or if a receiver or a manager on behalf of a creditor shall be appointed or if circumstances shall arise which entitle the court or the creditor to appoint a receiver or a manager or which entitle the court to make a winding up order.
- x. If the Contractor shall suffer an execution being levied on his goods and allow it to be

continued for a period of 21 days.

- xi. If the Contractor assigns, transfers, sublets (engagement of labour on a piece- work basis or of labour with materials not to be incorporated in the work, shall not be deemed to be subletting) or otherwise parts with or attempts to assign, transfer, sublet or otherwise parts with the entire works or any portion thereof without the prior written approval of the Engineer-in-Charge.

When the Contractor has made himself liable for action under any of the cases aforesaid, the Engineer-in-Charge on behalf of the Employer shall have powers:

- a) To determine the Contract as aforesaid (of which termination notice in writing to the Contractor under the hand of the Engineer-in-Charge shall be conclusive evidence). Upon such determination, the Security Deposit already recovered and Performance Security under the Contract shall be liable to be forfeited and shall be absolutely at the disposal of the Employer.
- b) After giving notice to the Contractor to measure up the work of the Contractor and to take such whole, or the balance or part thereof, as shall be un-executed out of his hands and to give it to another Contractor to complete the work. The Contractor, whose Contract is determined as above, shall not be allowed to participate in the tendering process for the balance work.

In the event of above courses being adopted by the Engineer-in-Charge, the Contractor shall have no claim to compensation for any loss sustained by him by reasons of his having purchased or procured any materials or entered into any engagements or made any advances on account or with a view to the execution of the work or the performance of the Contract. And in case action is taken under any of the provision aforesaid, the Contractor shall not be entitled to recover or be paid any sum for any work thereof or actually performed under this Contract unless and until the Engineer-in-Charge has certified in writing the performance of such work and the value payable in respect thereof and he shall only be entitled to be paid the value so certified.

Note:

Actions under Clause 2 and 3 are independent.

The compensation under Clause 2 is for loss caused due to delay in performance, whereas, the compensation under Clause 3 is for consequential losses due to non-performance of the Contract. Hence, the Employer is entitled to compensation under Clause 3 and Clause 2 independently. Hence, the Employer is empowered to take action under Clause 2 for levy of compensation depending on liability of Contractor under Clause 2 based on the delay at the stage of Clause 3 action, before determination.

Clause 4: Contractor Liable to Pay Compensation Even if Action not Taken under Clause 3

In any case in which any of the powers conferred upon the Engineer-in-Charge by Clause 3 thereof, shall have become exercisable and the same are not exercised, the non-exercise thereof shall not constitute a waiver of any of the conditions hereof and such powers shall notwithstanding be exercisable in the event of any future case of default by the Contractor and the liability of the Contractor for compensation shall remain unaffected. In the event of the Engineer-in-Charge putting in force all or any of the powers vested in him under the preceding clause he may, if he so

desires after giving a notice in writing to the Contractor, take possession of (or at the sole discretion of the Engineer-in-Charge which shall be final and binding on the Contractor) use as on hire (the amount of the hire money being also in the final determination of the Engineer-in-Charge) all or any tools, plant, materials and stores, in or upon the works, or the site thereof belonging to the Contractor, or procured by the Contractor and intended to be used for the execution of the work/or any part thereof, paying or allowing for the same in account at the Contract rates, or, in the case of these not being applicable, at current market rates to be certified by the Engineer-in-Charge, whose certificate thereof shall be final, and binding on the Contractor, clerk of the works, foreman or other authorized agent to remove such tools, plant, materials, or stores from the premises (within a time to be specified in such notice) in the event of the Contractor failing to comply with any such requisition, the Engineer-in-Charge may remove them at the Contractor's expense or sell them by auction or private sale on account of the Contractor and his risk in all respects and the certificate of the Engineer-in-Charge as to the expenses of any such removal and the amount of the proceeds and expenses of any such sale shall be final and conclusive against the Contractor.

Clause 5: Time and Extension for Delay

The time allowed for execution of the Works as specified in the Contract or the extended time in accordance with these conditions shall be the essence of the Contract. The execution of the works shall commence from such time period as mentioned in Contract. If the Contractor commits default in commencing the execution of the work as aforesaid, the Employer shall without prejudice to any other right or remedy available in law, be at liberty to forfeit the Performance Security absolutely.

Clause 5.1: As soon as possible but within 7 (seven) days from the date of commencement of work, the Contractor shall submit a Time and Progress Chart for each milestone and get it approved by the Engineer-in-Charge. The Chart shall be prepared in direct relation to the time stated in the Contract documents for completion of items of the works. It shall indicate the forecast of the dates of commencement and completion of various trades of sections of the work and may be amended as necessary by agreement between the Employer and the Contractor within the limitations of time imposed in the Contract documents, and further to ensure good progress during the execution of the work, the Contractor shall in all cases in which the time allowed for any work, exceeds 15 days (save for special jobs for which a separate programme has been agreed upon) complete the work as per scheduled date of completion.

In case of non-submission of construction programme by the Contractor, the program approved by the Engineer-in-Charge shall be deemed to be final.

The approval by the Engineer-in-Charge of such programme shall not relieve the Contractor of any of the obligations under the contract.

Programme Chart

The Contractor shall prepare an integrated programme chart in MS Project/ Primavera software for the execution of work, showing clearly all activities from the start of work to completion, with details of manpower, equipment and machinery required for the fulfilment of the programme

within the stipulated period or earlier and submit the same for approval to the Engineer-in-Charge within the specified time.

- (i) The programme chart should include the following:
 - (a) Descriptive note explaining sequence of the various activities.
 - (b) Network (PERT/ CPM/ BARChart).
 - (c) Programme for procurement of materials by the Contractor.
 - (d) Programme of procurement of machinery/ equipment having adequate capacity, commensurate with the quantum of work to be done within the stipulated period, by the Contractor.
- (ii) If at any time, it appears to the Engineer-in-Charge that the actual progress of work does not conform to the approved programme referred above or after rescheduling of milestones, the Contractor shall produce a revised programme within 7 (seven) days, showing the modifications to the approved programme to ensure timely completion of the work. The modified schedule of programme shall be approved by the Engineer-in-Charge.
- (iii) The submission for approval by the Engineer-in-Charge of such programme or such particulars shall not relieve the Contractor of any of the duties or responsibilities under the Contract. This is without prejudice to the right of Engineer-in-Charge to take action against the Contractor as per terms and conditions of the agreement.
- (iv) The Contractor shall submit the progress report using MS Project/ Primavera software with baseline programme referred above for the work done during previous month to the Engineer-in-charge on or before 5th & 20th day of each month.

The Contractor shall furnish to the Engineer-in-Charge progress report in triplicate on 5th & 20th day of every month also indicating the following:

Sl. No.	Item of Work	Scheduled progress for the month	Actual shortfall if any	Reasons for shortfall	Steps taken to make-up the shortfall

The Contractor shall employ sufficient number of skilled and unskilled labour required for the work for maintaining the progress of work as stipulated in the Time schedule. The trade-wise labour strength should be intimated to the Engineer-in-Charge in writing. The skilled labour shall be increased if required by Engineer-in-Charge to maintain progress of the work. However, no additional payment shall be made for the same.

5.2 If the work(s) be delayed by:

- (i) Force majeure, or
- (ii) Abnormally bad weather, or
- (iii) Serious loss or damage by fire, or
- (iv) Civil commotion, local commotion of workmen, strike or lockout, affecting any of the trades employed on the work, or
- (v) Delay on the part of other Contractors or tradesmen engaged by Engineer-in-Charge in executing work not forming part of the Contract, or
- (vi) Non-availability or break down of tools and Plant to be supplied or any other cause which, in the absolute discretion of the Engineer-in-Charge is beyond the Contractor's control.

Then upon the happening of any such event causing delay give notice thereof in writing to the Engineer-in-Charge but shall nevertheless use constantly his best endeavors to prevent or make good the delay and shall do all that may be reasonably required to the satisfaction of the Engineer-in-Charge to proceed with the works.

The Contractor shall have no claim of damages for extension of time granted or rescheduling of milestone/s for events listed in sub-clause 5.2.

- 5.3** In case the work is hindered by the Employer or for any reason / event, for which the Employer is responsible, the Engineer-in-Charge, if justified, give a fair and reasonable extension of time and reschedule the mile stones for completion of work. Such extension of time or rescheduling of milestone/s shall be without prejudice to any other right or remedy of the parties in contract or in law; provided further that for concurrent delays under this sub-clause and sub-clause 5.2 to the extent the delay is covered under sub-clause 5.2 the Contractor shall be entitled to only extension of time and no compensation/damages.
- 5.4** Request for rescheduling of Milestones and extension of time, to be eligible for consideration, shall be made by the Contractor in writing within fourteen days of the happening of the event causing delay on the prescribed form to the Engineer-in-Charge. The Contractor may also, if practicable, indicate in such a request the period for which extension is desired. The Contractor shall indicate in such a request the period by which rescheduling of milestone/s or extension of time is desired. With every request for rescheduling of milestones, or if at any time the actual progress of work falls behind the approved programme by more than 10% of the stipulated period of completion of contract, the Contractor shall produce a revised programme which shall include all details of pending drawings and decisions required to complete the contract and also the target dates by which these details should be available without causing any delay in execution of the work. An amount as deemed appropriate by the Engineer-in-Charge shall be deducted on per day basis in case of delay in submission of the revised programme.
- 5.4.1** In any such case the Engineer-in-Charge may give a fair and reasonable extension of time for completion of work or reschedule the mile stones. Engineer-in-Charge shall finalize/reschedule a particular mile stone before taking an action against subsequent mile stone. Such extension or rescheduling of the milestones shall be communicated to the Contractor by the

Engineer-in-Charge in writing, within 21 days of the date of receipt of such request from the Contractor in prescribed form. In event of non-application by the Contractor for extension of time Engineer-in-Charge after affording opportunity to the Contractor, may give, supported with a programme (as specified under 5.4 above), a fair and reasonable extension within a reasonable period of occurrence of the event.

- 5.5** In case the work is delayed by any reasons, in the opinion of the Engineer-in-Charge, by the Contractor for reasons beyond the events mentioned in sub-clause 5.2 and beyond the justified extended date; without prejudice to right to take action under Clause 3, the Engineer-in-Charge may grant extension of time required for completion of work without rescheduling of milestones. The Contractor shall be liable for levy of compensation for delay for such extension of time.

Clause 6: Measurements of Work Done

Engineer-in-Charge shall, except as otherwise provided, ascertain and determine by measurement the value of work done in accordance with the contract.

All measurements of all items having financial value shall be entered by the Contractor and compiled in the shape of the Computerized Measurement Book having pages of A-4 size as per the format of the Employer so that a complete record is obtained of all the items of works performed under the contract.

All such measurements recorded by the Contractor or his authorized representative from time to time, during the progress of the work, shall be got checked by the Contractor from the Engineer-in-Charge or his authorized representative as per interval or program fixed in consultation with Engineer-in-Charge or his authorized representative. After the necessary corrections made by the Engineer-in-Charge, the measurement sheets shall be returned to the Contractor for incorporating the corrections and for resubmission to the Engineer-in-Charge for the dated signatures by the Engineer-in-Charge and the Contractor or their representatives in token of their acceptance.

Whenever bill is due for payment, the Contractor would initially submit draft computerized measurement sheets and these measurements would be got checked/test checked from the Engineer-in-Charge and/or his authorized representative. The Contractor will, thereafter, incorporate such changes as may be done during these checks/test checks in his draft computerized measurements, and submit to the Employer a computerized measurement book, duly bound, and with its pages machine numbered. The Engineer-in-Charge and/or his authorized representative would thereafter check this MB and record the necessary certificates for their checks/test checks.

The final, fair, computerized measurement book given by the Contractor, duly bound, with its pages machine numbered, should be 100% correct, and no cutting or over-writing in the measurements would thereafter be allowed. If at all any error is noticed, the Contractor shall have to submit a fresh computerized MB with its pages duly machine numbered and bound. The Contractor shall submit two spare copies of such computerized MB's for the purpose of reference and records.

The Contractor shall also submit to the Employer separately his computerized Abstract of Cost

and the bill based on these measurements, duly bound, and its pages machine numbered along with two spare copies of the bill. Thereafter, this bill will be processed by the Engineer-in-Charge.

The Contractor shall, without extra charge, provide all assistance with every appliance, labour and other things necessary for checking of measurements/levels by the Engineer-in-Charge or his representative.

It is also a term of this contract that checking and/or test checking the measurements of any item of work in the measurement book and/or its payment in the interim, on account of final bill shall not be considered as conclusive evidence as to the sufficiency of any work or material to which it relates nor shall it relieve the Contractor from liabilities from any over measurement or defects noticed till completion of the Defects Liability Period.

Clause 7: Payment on Intermediate Certificate to be regarded as Advances

The interim or running account bill shall be submitted by the Contractor for work executed on the basis of recorded measurements on the format of the Employer in triplicate on or before the date of every month fixed for the same by the Engineer-in-Charge. Contractor shall submit the bill with all requisite certificates/ documents. Engineer-in-Charge shall arrange to have the bill verified by taking or causing to be taken where necessary, the requisite measurement of the work within 15 working days. Observations if any shall be conveyed by the Engineer-in-Charge to the Contractor within 25 working days. Contractor shall resubmit the bill after compliance of observations. Payment on account of amount admissible shall be made by the Engineer-in-Charge certifying the sum to which the Contractor is considered entitled by way of interim payment at such rates as decided by Engineer-in-Charge. The amount shall be paid by 30 working days after the day of presentation of the corrected bill by the Contractor to the Engineer-in-Charge or his representative, subject to fulfillment of clause 37 of this section. Any delay in release of payment by Employer shall not entitle the Contractor to any compensation / interest from Employer.

All such interim payments shall be regarded as payment by way of advances against final payment only and shall not preclude the requiring of bad, unsound and imperfect or unskilled work to be rejected, removed, taken away and reconstructed or re-erected. Any certificate given by the Engineer-in-Charge relating to the work done or materials delivered forming part of such payment, may be modified or corrected by any subsequent such certificate(s) or by the final certificate and shall not by itself be conclusive evidence that any work or materials to which it relates is/are in accordance with the Contract and specifications. Any such interim payment, or any part thereof shall not in any respect conclude, determine or affect in any way powers of the Engineer-in-Charge under the Contract or any of such payments be treated as final settlement and adjustment of accounts or in any way vary or affect the Contract.

Pending consideration of extension of date of completion, interim payments shall continue to be made as herein provided without prejudice to the right of the Employer to take action under the terms of this Contract for delay in the completion of work, if the extension of date of completion is not granted by the Competent Authority.

It is clearly agreed and understood by the Contractor that notwithstanding anything to the contrary that may be stated in the agreement between Employer and the Contractor; the Contractor shall become entitled to payment only after Employer has received the corresponding payment(s) from

the Owner for the work done by the Contractor. Any delay in the release of payment by the Owner to Employer leading to a delay in the release the corresponding payment by Employer to the Contractor shall not entitle the Contractor to any compensation/interest from Employer.

All payments shall be released by way of e-transfer through RTGS in India directly at their Bank account by Employer.

Clause 7A

No Running Account Bill shall be paid for the work till the applicable labour licenses, registration with EPFO, ESIC / BOCW Welfare Board, whatever applicable are submitted by the Contractor to the Engineer-in-Charge.

Clause 8: Completion Certificate and Completion Plans

Within ten days of the completion of the Works, the Contractor shall give notice of such completion to the Engineer-in-Charge and within ninety (90) days of the receipt of such notice, the Engineer-in-Charge shall inspect the work and if there is no defect in the work, shall furnish the Contractor with a final certificate of completion, otherwise a provisional certificate of physical completion indicating defects (a) to be rectified by the Contractor and/or (b) for which payment will be made at reduced rates, shall be issued. But no final certificate of completion shall be issued, nor shall the work be considered to be complete until the Contractor shall have removed from the premises on which the work shall be executed all scaffolding, surplus materials, rubbish and all huts and sanitary arrangements required for his/their work people on the site in connection with the execution of the works as shall have been erected or constructed by the Contractor(s) and cleaned off the dirt from all wood work, doors, windows, walls, floor or other parts of the building, in, upon, or about which the work is to be executed or of which he may have had possession for the purpose of the execution; thereof, and not until the work shall have been measured by the Engineer-in-Charge. If the Contractor shall fail to comply with the requirements of this Clause as to removal of scaffolding, surplus materials and rubbish and all huts and sanitary arrangements as aforesaid and cleaning off dirt on or before the date fixed for the completion of work, the Engineer-in-Charge may at the expense of the Contractor remove such scaffolding, surplus materials and rubbish etc., and dispose of the same as he thinks fit and clean off such dirt as aforesaid, and the Contractor shall have no claim in respect of scaffolding or surplus materials as aforesaid except for any sum actually released by the sale thereof.

The completion certificate shall be issued to the Contractor after submission of all necessary completion/ occupational certificates from all concerned departments such as local urban bodies, Fire Department, State Electricity Board etc. of that area in accordance with statutory approvals as given hereunder to enable Employer/Owner to occupy and commission the project with services. No part completion certificate/ occupational certificate will be issued to Contractor.

Statutory Approvals

The scope includes pre- and post-construction approvals and permits from local authorities and statutory bodies to start the construction works and also to take occupancy. The Contractor on behalf of Employer wherever required shall obtain all approvals and statutory Clearances from

Local Bodies, Explosive Department, State Government, Water Authority, Ground Water Authority, Pollution Control Board, Urban Development Ministry, Fire Department, Civil Aviation Department, Forest Department, etc. of that area to enable to start the construction works and also to enable Owner to occupy and commission with services. Unless the Contractor submits the statutory Clearances for post construction, the Works shall not be considered as complete. The Statutory fee shall be paid by Contractor in order to get clearances from the concerned departments. However, the same shall be reimbursed by the Employer on production of documentary evidence without overhead or any additional charges.

Clause 8a: Completion Plans to be submitted by the Contractor

- i) The Contractor shall submit completion plans for Internal and External Civil, Electrical, Plumbing and Fire Fighting Services within 30 days of the completion of the work, provided that the service plans having been issued for execution by the Engineer-in-Charge, unless the Contractor, by virtue of any other provision in the contract, is required to prepare such plans.
- ii) The "As Built" Drawings and completion report shall be submitted by the Contractor within 30 days from the date of completion works.

Clause 9: Payment of Final Bill

The final bill shall be submitted by the Contractor in the same manner as specified in interim bills within three months of physical completion of the work or within one month of the date of the final certificate of completion furnished by the Engineer-in-Charge whichever is earlier. No further claims shall be made by the Contractor after submission of the final bill and these shall be deemed to have been waived and extinguished. Payments of those items of the bill in respect of which there is no dispute and of items in dispute, for quantities and rates as approved by Engineer-in-Charge, will be made within six months, the period being reckoned from the date of receipt of the bill by the Engineer-in-Charge or his authorized representative.

Clause 9A: Payment of Contractor's Bills to Banks: Not applicable**Clause 10: Materials Supplied by the Employer: Not applicable****Clause 10A:****Materials to be provided by Contractor**

The Contractor shall, at his own expense, provide all materials, required for the works.

The Contractor shall, at his own expense and without delay, supply to the Engineer-in-Charge samples of materials to be used on the work and shall get these approved in advance. All such materials to be provided by the Contractor shall be in conformity with the specifications laid down or referred to in the Contract. The Contractor shall, if requested by the Engineer-in-Charge furnish proof, to the satisfaction of the Engineer-in-Charge that the materials so comply. The Engineer-in-Charge shall within thirty days of supply of samples or within such further period as he may require intimate to the Contractor in writing whether samples are approved by him or not. If

samples are not approved, the Contractor shall forthwith arrange to supply to the Engineer-in-Charge for his approval, fresh samples complying with the specifications laid down in the Contract. When materials are required to be tested in accordance with specifications, approval of the Engineer-in-Charge shall be issued after the test results are received.

The Contractor shall at his risk and cost submit the samples of materials to be tested or analyzed and shall not make use of or incorporate in the work any materials represented by the samples until the required tests or analysis have been made and materials finally accepted by the Engineer-in-Charge. The Contractor shall not be eligible for any claim or compensation either arising out of any delay in the work or due to any corrective measures required to be taken on account of and as a result of testing of materials.

The Contractor shall, at his risk and cost, make all arrangements and shall provide all facilities as the Engineer-in-Charge may require for collecting, and preparing the required number of samples for such tests at such time and to such place or places as may be directed by the Engineer-in-Charge and bear all charges and cost of testing. The Engineer-in-Charge or his authorized representative shall at all times have access to the works and to all workshops and places where work is being prepared or from where materials, manufactured articles or machinery are being obtained for the works and the Contractor shall afford every facility and every assistance in obtaining the right to such access.

The Engineer-in-Charge shall have full powers to require the removal from the premises of all materials which in his opinion are not in accordance with the specifications and in case of default, the Engineer-in-Charge shall be at liberty to employ at the expense of the Contractor, other persons to remove the same without being answerable or accountable for any loss or damage that may happen or arise to such materials. The Engineer-in-Charge shall also have full powers to require other proper materials to be substituted thereof and in case of default, the Engineer-in-Charge may cause the same to be supplied and all costs which may attend such removal and substitution shall be borne by the Contractor.

The Contractor shall at his own expense, provide a material testing lab at the site for conducting routine field tests. The lab shall be equipped at least with the testing equipment as specified in Contract.

If the Engineer-in-Charge instructs the Contractors to carry out a test not specified in the Specification to check whether any work has a Defect. Such tests are to be carried out by the Contractor by deploying agencies and paying all the cost for such tests.

Clause 10B:

(i) Secured Advance on Non-perishable Materials

The Contractor, on signing an indenture in the form to be specified by the Engineer-in-Charge, shall be entitled to be paid during the progress of the execution of the work up to 75 (seventy-five) % of the assessed value of any materials which are in the opinion of the Engineer-in-Charge non-perishable, non-fragile and non-combustible and are in accordance with the Contract and which have been brought on the site in connection therewith and are adequately stored and/or protected against damage by weather or other causes but which have not at the

time of advance been incorporated in the works. When materials on account of which an advance has been made under this sub-clause are incorporated in the work, the amount of such advance shall be recovered/ deducted from the next payment(s) made under any of the clause or clauses of this Contract.

(ii) Mobilization Advance

If requested by the Contractor, the Employer shall make interest bearing advance payment for mobilization of labour, stores and workshops including camps, labour sheds, machineries and construction plant, etc. for preliminary and enabling Works, after the signing of Contract agreement to the extent of 10% (ten percent) of Contract price against an Unconditional Bank Guarantee issued by Scheduled Commercial Bank/ Nationalized Bank. Such advance shall be paid in two installments. The first installment of 5% (five percent) shall be released by the Engineer-in-charge to the Contractor on a request made by the Contractor to the Engineer-in-charge in this behalf. The second and subsequent installment of 5% (five percent) shall be released by the Engineer-in-Charge after the Contractor furnishes a proof of the satisfactory utilization of the earlier installment to the entire satisfaction of the Engineer-in-charge.

The mobilization advance bears simple interest at the rate of 10% and shall be calculated from the date of payment to the date of recovery (365 days in a year) both days inclusive, on the outstanding amount of advance.

Before any installment of advance is released, the Contractor shall execute a Bank Guarantee Bond from a Scheduled Commercial Bank/ Nationalized Bank approved by Reserve Bank of India (RBI) for the amount equal to 110% of amount of advance and valid till the Completion period.

Recovery of such sums advanced shall be made by the deduction from the Contractors bills commencing after first ten percent of the gross value of the work is executed and paid, on pro-rata percentage basis to the gross value of the work billed beyond 10% in such away that the entire advance is recovered by the time eighty percent (80%) of gross value of the Contract is executed and paid together with interest due on the entire outstanding amount upto the date of recovery of the installment.

If the advance payment has not been repaid prior to the issue of the Taking over Certificate for the work or prior to termination under Clause 50 and 51 of Section-IV, the balance advance is payable by the Contractor to the Employer.

A separate dedicated Bank Account shall be opened by the Contractor in any Nationalized Bank before release of mobilization/ tools & plants advance and shall be utilized for the purpose of the project only.

Installments of Mobilization advance except the first installment shall be released only after receiving the utilization certificate supported by Bank statement of the said account showing the disbursement of mobilization advance by the Contractor.

(iii) Plant Machinery & Shuttering Material Advance: Not Applicable

Clause 10C**Price Adjustment due to increase/decrease in prices/wages after Receipt of Tender for Works (Price Escalation/De-escalation)**

There will be no escalation on account of any increase in price index in the price of materials or labors, imposition of sales tax or enactment of any new law or imposition of levies etc. No price escalation shall be applicable even during the extended period for completing the works. No extra claim in this regard will be entertained

Clause 10D: Materials Obtained During Excavation

The Contractor shall treat all materials obtained during excavation of the site for a work, etc. as Government property and the same shall be disposed-off according to the instructions in writing issued by the Engineer-in-Charge.

Clause 11: Works to be executed in accordance with Specifications, Drawings, and Orders etc.

The Contractor shall execute the work as per the sequence submitted by the Contractor and approved by the Engineer-in-Charge from time to time so that all other items of the work to be executed by other agencies are completed progressively along with the main work.

The Contractor shall execute the whole and every part of the work in the most substantial and workman like manner both as regards materials and otherwise in every respect in strict accordance with the specifications. The Contractor shall also conform exactly, fully and faithfully to the design, drawings and instructions in writing in respect of the work signed by the Engineer-in-Charge and the Contractor shall be furnished free of charge one copy of the Contract documents together with specifications, designs, drawings and instructions as are not included in the standard specifications or in any Bureau of Indian Standard or any other, published standard or code or, Schedule of Rates or any other printed publication referred to elsewhere in the Contract.

The Contractor shall comply with the provisions of the Contract and with the care and diligence execute and maintain the works and provide all labour and materials, tools and plants including for measurements and supervision of all works, structural plans and other things of temporary or permanent nature required for such execution and maintenance in so far as the necessity for providing these, is specified or is reasonably inferred from the Contract. The Contractor shall take full responsibility for adequacy, suitability and safety of all the works and methods of construction.

At least 10% of prescribed Tests as per Central Public Works Department Manual/ IS Codes of construction materials shall be carried out from the outside approved/ NABL recognized Laboratory as may be approved by Engineer-in-Charge without any extra expenditure to Employer.

The Contractor shall establish a field test laboratory on the site with latest equipment's for carrying out field tests of construction materials and shall maintain proper records of all the test results.

Clause 12: Deviations/ Variations: Extent

12.1 The Engineer-in-Charge shall have power (i) to make alteration in, omissions from, additions to, or substitutions for the original specifications, drawings, designs and instructions that may appear to him to be necessary or advisable during the progress of the work, (ii) increase or decrease the quantity of any work included in the Contract, (iii) change the character or quality or kind of any such work, (iv) change any specified sequence, or timing of construction of any part of the Works and (v) to omit a part of the works in case of non-availability of a portion of the site or for any other reasons and the Contractor shall be bound to carry out the works in accordance with any instructions given to him in writing signed by the Engineer-in-Charge and such alterations, omissions, additions or substitutions, etc. shall form part of the Contract as if originally provided therein and any altered, additional or substituted work which the Contractor may be directed to do in the manner specified above as part of the works, shall be carried out by the Contractor on the same conditions in all respects on which he agreed to do the main work.

No such variations shall in any way vitiate or invalidate the Contract, but the effect if any, of all such variations shall be valued in accordance with Clause – 12A.

Provided that where the issue of an instruction to vary the Works is necessitated by some default of or breach of Contract by the Contractor or for which he is responsible, any additional cost attributable to such default shall be borne by the Contractor.

12.2 The time for completion of the works shall, in the event of any deviations resulting in additional cost over the tendered value sum being ordered, be extended, if requested by the Contractor, as follows;

- i) In the proportion which the additional cost of the altered, additional or substituted work, bears to the original tendered value plus
- ii) 25% of the time calculated in (i) above or such further additional time as may be considered reasonable by the Engineer-in-Charge.

12.3 The unit rate mentioned in Schedule of Quantities (SoQ) for the individual items shall apply for the quantities mentioned in Schedule of Quantities plus hundred percent (100%) of SoQ.

When such deviations exceed the above limit then the rates for such variations and the altered, additional and substituted item shall be determined in accordance with procedure indicated under clause-12A of Section-IV.

12.4 Any operation incidental to, or necessary for proper execution of the item included in the Schedule of quantities or in the Schedule of rates mentioned above, whether or not, specifically indicated in the description of the item and the relevant specifications, shall be deemed to be included in the rates quoted by the Tenderer or the rate given in the said Schedule of rates, as the case may be. Nothing extra shall be admissible for such operations.

Clause 12A: Payments for Change of Scope (Variations):

The rates for extra / additional, substituted items and deviated items of Work as are required to be executed due to variations, as stated in Clause-12 above shall be payable in the manner as

stated hereunder:

- 12A.1 In the case of extra item(s) (items that are completely new), which are Non-Scheduled Items (not available in the Delhi Schedule of Rates), the Contractor may within fifteen days of receipt of order or occurrence of the item(s) claim rates, supported by proper analysis, which shall include invoices, vouchers etc. from Manufacturer's specification for the work failing which the rates approved by Engineer-in-Charge shall be binding and the Engineer-in-Charge shall within one month of the receipt of the claims supported by analysis, after giving consideration to the analysis of the rates submitted by the Contractor, determine the rates on the basis of the market rates and the Contractor shall be paid in accordance with the rates so determined. Market Rate shall be the rate as decided by the Engineer-in-Charge on the basis of the cost of materials and labour at the time of commencement of execution of the item, where the work is to be executed, plus 15% percentage towards all overheads and profits.
- 12A.2 In case the extra item(s) or substituted item (s) being the Scheduled Item (Delhi Schedule of rates 2021), these shall be paid as per the Delhi Schedule of rates, 2021, plus/minus tender percentage with respect to estimated cost.
- 12A.3 In case the rate for the substituted item & agreement item (to be substituted) both are not existing in Delhi Schedule of Rate at which the Cost Estimates have been prepared, then the rate for the agreement item and substituted item shall be determined in the manner as mentioned in the following para:
- a) If the market rate for the substituted item so determined is more than the market rate of the agreement item (to be substituted), the rate payable to the Contractor for the substituted item shall be the rate for the agreement item (to be substituted) so increased to the extent of the difference between the market rates of substituted item and the agreement item (to be substituted).
 - b) If the market rate for the substituted item so determined is less than the market rate of the agreement item (to be substituted), the rate payable to the Contractor for the substituted item shall be the rate for the agreement item (to be substituted) so decreased to the extent of the difference between the market rates of substituted item and the agreement item (to be substituted).
- 12A.4 The rate for deviated item(s) beyond the specified limit as mentioned in Clause 12.3 above shall be determined in the following manner:
- a) The deviated item that does not exist in Delhi Schedule of Rates, the same shall be determined in the manner specified in Clause 12A.1 above.
 - b) The deviated item that exists in Delhi Schedule of Rates, the same shall be paid as per the scheduled rate prevailing at time of execution of work.

Under no circumstances the Contractor shall at any stage, suspend the work on account of non-settlement on rates of such deviated, altered, additional or substituted items.

Clause 13: Foreclosure of Contract due to Abandonment or Reduction in Scope of Work

If at any time after acceptance of the tender, Engineer-in-Charge shall decide to abandon or

reduce the scope of the works for any reason whatsoever and hence not require the whole or any part of the works to be carried out, the Engineer-in-Charge shall give notice in writing to that effect to the Contractor and the Contractor shall act accordingly in the matter. The Contractor shall have no claim to any payment of compensation or otherwise whatsoever, on account of any profit or advantage which he might have derived from the execution of the works in full but which he did not derive in consequence of the foreclosure of the whole or part of the works.

The Contractor shall be paid at Contract rates, full amount for works executed at site and, in addition, a reasonable amount as certified by the Engineer-in-Charge for the items hereunder mentioned which could not be utilized on the work to the full extent in view of the foreclosure;

- i. Any expenditure incurred on preliminary site work, e.g., temporary access roads, temporary labour huts, staff quarters and site office; storage accommodation and water storage tanks.
- ii. The Employer shall have the option to take over Contractor's materials or any part thereof either brought to site or of which the Contractor is legally bound to accept delivery from Suppliers (for incorporation in or incidental to the work) provided, however the Employer shall be bound to take over the materials or such portions thereof as the Contractor does not desire to retain. For materials taken over or to be taken over by the Employer, cost of such materials as detailed by Engineer-in-Charge shall be paid. The cost shall, however, take into account purchase price, cost of transportation and deterioration or damage which may have been caused to materials whilst in the custody of the Contractor.
- iii. If any materials supplied by the Employer are rendered surplus, the same except normal wastage shall be returned by the Contractor to the Employer at rates not exceeding those at which these were originally issued, less allowance for any deterioration or damage which may have been caused whilst the materials were in the custody of the Contractor. In addition, cost of transporting such materials from site to the Employer's stores, if so required by the Employer, shall be paid.
- iv. Reasonable compensation for transfer of T & P from site to Contractor's permanent stores or to his other works, whichever is less. If T & P are not transported to either of the said places, no cost of transportation shall be payable.
- v. Reasonable compensation for repatriation of Contractor's site staff and imported labour to the extent necessary.

The Contractor shall, if required by the Engineer-in-Charge, furnish to him, books of account, wage books, time sheets and other relevant documents and evidence as may be necessary to enable him to certify the reasonable amount payable under this condition.

The reasonable amount of items on (i), (iv) and (v) above shall not be in excess of 2% of the cost of the work remaining incomplete on the date of closure, i.e. total stipulated cost of the work as per accepted tender less the cost of work actually executed under the Contract and less the cost of Contractor's materials at site taken over by the Employer as per item (ii) above. Provided always that against any payments due to the Contractor on this account or otherwise, the Engineer-in-Charge shall be entitled to recover or be credited with any outstanding balances due from the Contractor for advance paid in respect of any tool, plants and materials and any

other sums which at the date of termination were recoverable by the Employer from the Contractor under the terms of the Contract.

In the event of action being taken under Clause 13 to reduce the scope of work, the Contractor may furnish fresh Performance Security on the same conditions, in the same manner and at the same rate for the balance tendered amount and initially valid up to the extended date of completion or stipulated date of completion if no extension has been granted plus minimum 60 days beyond that. Wherever such a fresh Performance Security is furnished by the Contractor the Engineer-in-Charge may return the previous Performance Security.

Clause 14: Carrying out Part Work at Risk & Cost of Contractor

If the Contractor:

- (i) At any time makes default during currency of work or does not execute any part of the work with due diligence and continues to do so even after a notice in writing of 7 days in this respect from the Engineer-in-Charge; or
- (ii) Commits default in complying with any of the terms and conditions of the Contract and does not remedy it or takes effective steps to remedy it within 7 days even after a notice in writing is given in that behalf by the Engineer-in-Charge; or

Fails to complete the work(s) or items of work with individual dates of completion, on or before the date(s) so determined, and does not complete them within the period specified in the notice given in writing in that behalf by the Engineer-in-Charge. The Engineer-in-Charge without invoking action under clause 3 of GCC may, without prejudice to any other right or remedy against the Contractor which have either accrued or accrue thereafter to the Employer, by a notice in writing to take the part work / part incomplete work of any item(s) out of his hands and shall have powers to:

- (a) Take possession of the site and any materials, constructional plant, implements, stores, etc., thereon; and/or
- (b) Carry out the part work/ part in complete work of any item(s) by any means at the risk and cost of the Contractor.

The Engineer-in-Charge shall determine the amount, if any, is recoverable from the Contractor for completion of the part work/ part in complete work of any item(s) taken out of his hands and execute at the risk and cost of the Contractor, the liability of Contractor on account of loss or damage suffered by the Employer because of action under this clause shall not exceed 10% of the tendered value of the work.

In determining the amount, credit shall be given to the Contractor with the value of work done in all respect in the same manner and at the same rate as if it had been carried out by the original Contractor under the terms of his Contract, the value of Contractor's materials taken over and incorporated in the work and use of plant and machinery belonging to the Contractor. The certificate of the Engineer-in-Charge as to the value of work done shall be final and conclusive against the Contractor provided always that action under this clause shall only be taken after giving notice in writing to the Contractor. Provided also that if the expenses incurred by the

Employer are less than the amount payable to the Contractor at his agreement rates, the difference shall not be payable to the Contractor.

Any excess expenditure incurred or to be incurred by the Employer in completing the part work/part in complete work of any item(s) or the excess loss of damages suffered or may be suffered by the Employer as aforesaid after allowing such credit shall without prejudice to any other right or remedy available to the Employer in law or per as agreement be recovered from any money due to the Contractor on any account, and if such money is insufficient, the Contractor shall be called upon in writing and shall be liable to pay the same within 30 days.

If the Contractor fails to pay the required sum within the aforesaid period of 30 days, the Engineer-in-Charge shall have the right to sell any or all of the Contractors' unused materials, constructional plant, implements, temporary building at site etc. and adjust the proceeds of sale thereof towards the dues recoverable from the Contractor under the Contract and if thereafter there remains any balance outstanding, it shall be recovered in accordance with the provisions of the Contract.

In the event of above course being adopted by the Engineer-in-Charge, the Contractor shall have no claim to compensation for any loss sustained by him by reason of his having purchased or procured any materials or entered into any engagements or made any advance on any account or with a view to the execution of the work or the performance of the Contract.

Clause 15: Suspension of Work

- i. The Contractor shall, on receipt of the order in writing of the Engineer-in-Charge, (whose decision shall be final and binding on the Contractor) suspend the progress of the works or any part thereof for such time and in such manner as the Engineer-in-Charge may consider necessary so as not to cause any damage or injury to the work already done or endanger the safety thereof for any of the following reasons:
 - a) On account of any default on the part of the Contractor or;
 - b) For proper execution of the works or part thereof for reasons other than the default of the Contractor; or
 - c) For safety of the works or part thereof.

The Contractor shall, during such suspension, properly protect and secure the works to the extent necessary and carry out the instructions given in that behalf by the Engineer-in-Charge.

- ii. If the suspension is ordered for reasons (b) and (c) in sub-para (i) above:
 - a) The Contractor shall be entitled to an extension of time equal to the period of every such suspension plus 25%, for completion of the item or group of items of work for which a separate period of completion is specified in the Contract and of which the suspended work forms a part, and;
 - b) If the total period of all such suspensions in respect of an item or group of items or work for which a separate period of completion is specified in the Contract exceeds thirty days, the Contractor shall, in addition, be entitled to such compensation as the Engineer-in-Charge may consider reasonable in respect of salaries and/or wages paid by the Contractor to his employees and labour at site, remaining idle during the period of suspension, adding thereto 2% to cover indirect expenses of the Contractor provided the Contractor submits his

- claim supported by details to the Engineer-in-Charge within fifteen days of the expiry of the period of 30 days.
- iii. If the works or part thereof is suspended on the orders of the Engineer-in-Charge for more than three months at a time, except when suspension is ordered for reason (a) in sub para (i) above, the Contractor may after receipt of such order serve a written notice on the Engineer-in-Charge requiring permission within fifteen days from receipt by the Engineer-in-Charge of the said notice, to proceed with the work or part thereof in regard to which progress has been suspended and if such permission is not granted within that time, the Contractor, if he intends to treat the suspension, where it affects only a part of the works as an omission of such part by the Employer or where it affects whole of the works, as an abandonment of the works by the Employer, shall within ten days of expiry of such period of 15 days give notice in writing of his intention to the Engineer-in-Charge. In the event of the Contractor treating the suspension as an abandonment of the Contract by the Employer, he shall have no claim to payment of any compensation on account of any profit or advantage which he might have derived from the execution of the work in full but which he could not derive in consequence of the abandonment. He shall, however, be entitled to such compensation, as the Engineer-in-Charge may consider reasonable, in respect of salaries and/or wages paid by him to his employees and labour at site, remaining idle in consequence adding to the total thereof 2% to cover indirect expenses of the Contractor provided the Contractor submits his claim supported by details to the Engineer-in-Charge within 30 days of the expiry of the period of 3 months.

Clause 16: Action in case Work not done as per Specifications

All works under or in course of execution or executed in pursuance of the Contract, shall at all times be open and accessible to the inspection and supervision of the Engineer-in-Charge, his authorized subordinates in charge of the work and all the superior officers, officer of the Quality Assurance Unit of the Employer or any organization engaged by the Employer for Quality Assurance and of the Chief Technical Examiner's Office, and the Contractor shall, at all times, during the usual working hours and at all other times at which reasonable notice of the visit of such officers has been given to the Contractor, either himself be present to receive orders and instructions or have a responsible agent duly accredited in writing, present for that purpose. Orders given to the Contractor's agent shall be considered to have the same force as if they had been given to the Contractor himself.

If it shall appear to the Engineer-in-Charge or his authorized subordinates in charge of the work of Quality Assurance or his subordinate officers or the officers of the organization engaged by the Employer for Quality Assurance, that any work has been executed with unsound, imperfect, or unskillful workmanship, or with materials or articles provided by him for the execution of the work which are unsound or of a quality inferior to that contracted or otherwise not in accordance with the Contract, the Contractor shall, on demand in writing which shall be made within the specified time given by the Engineer-in-Charge, notwithstanding that the same may have been passed, certified and paid for forthwith rectify, or remove and reconstruct the work so specified in whole or in part, as the case may require or as the case may be, remove the materials or articles so specified and provide other proper and

suitable materials or articles at his own charge and cost. In the event of the failing to do so within a period specified by the Engineer-in-Charge in his demand aforesaid, then the Contractor shall be liable to pay compensation at the same rate as under Clause 2 of GCC (for non-completion of the work in time) for this default.

In such case the Engineer-in-Charge may not accept the item of work at the rates applicable under the Contract but may accept such items at reduced rates as the authority specified in Contract may consider reasonable during the preparation of on account bills or final bill if the item is so acceptable without detriment to the safety and utility of the item and the structure or he may reject the work outright without any payment and/or get it and other connected and incidental items rectified, or removed and re-executed at the risk and cost of the Contractor. Decision of the Engineer-in-Charge to be conveyed in writing in respect of the same will be final and binding on the Contractor.

Clause 17: Contractor Liable for Damages, Defects During Defect Liability Period

The Defect Liability Period shall commence from the date of issue of the Taking Over Certificate or Completion Certificate whichever is later.

If the Contractor or his working people or servants shall break, deface, injure or destroy any part of construction works in which they may be working, or any building, road, road kerb, fence, enclosure, water pipe, cables, drains, electric or telephone post or wires, trees, grass or grassland, or cultivated ground contiguous to the premises on which the work or any part of it is being executed, or if any damage shall happen to the work while in progress, from any cause whatever or if any defect, shrinkage or other faults appear in the work within 12 months after a certificate, final or otherwise of its completion, shall have been given by the Engineer-in-Charge as aforesaid arising out of defective or improper materials or workmanship, the Contractor shall upon receipt of a notice in writing on that behalf make the same good at his own expense, or in default, the Engineer-in-Charge cause the same to be made good by other workmen and deduct the expense from any sums that may be due, or at any time thereafter may become due to the Contractor, or from his Security Deposit, or the proceed of sale thereof or of a sufficient portion thereof.

The Security Deposit of the Contractor shall be refunded in accordance with Clause 1A (ii) of GCC.

Clause 18: Contractor Supply Tools & Plants Etc.

The Contractor shall provide at his own cost all materials (except such special materials, if any, as may in accordance with the Contract be supplied from the Engineer-in-Charge's stores), machinery, tools & plants as specified in Contract. In addition to this, appliances, implements, other plants, ladders, cordage, tackle, scaffolding and temporary works required for the proper execution of the work, whether original, altered or substituted and whether included in the specifications or other documents forming part of the Contractor referred to in these conditions or not, or which may be necessary for the purpose of satisfying or complying with the requirements of the Engineer-in-Charge to any matter as to which under these conditions he is entitled to be satisfied, or which he is entitled to require together with carriage therefore to and

from the work. The Contractor shall also supply without charge the requisite number of persons with the means and materials, necessary for the purpose of setting out works, and counting, weighing and assisting the measurement for examination at any time and from time to time of the work or materials. Failing his so doing, the same may be provided by the Engineer-in-Charge at the expense of the Contractor and the expenses may be deducted, from any money due to the Contractor, under this Contract or otherwise and/ or from his Security Deposit or the proceeds of sale thereof, or of a sufficient portion thereof.

Clause 18A: Recovery of Compensation Paid to Workmen

In every case in which by virtue of the provisions sub-section (1) of Section 12, of the Workmen's Compensation Act, 1923, the Employer is obliged to pay compensation to a workman employed by the Contractor, in execution of the works, the Employer will recover from the Contractor, the amount of the compensation so paid; and, without prejudice to the rights of the Employer under sub-section (2) of Section 12, of the said Act, the Employer shall be at liberty to recover such amount or any part thereof by deducting it from the Security Deposit or from any sum due by the Employer to the Contractor whether under this Contract or otherwise. The Employer shall not be bound to contest any claim made against it under sub-section (1) of Section 12, of the said Act, except on the written request of the Contractor and upon his giving to the Employer full security for all costs for which the Employer might become liable in consequence of contesting such claim.

Clause 18B: Ensuring Payment and Amenities to Workers, if Contractor Fails

In every case in which by virtue of the provisions of the Contract Labour (Regulation and Abolition) Act, 1970, and of the Contract Labour (Regulation and Abolition) Central Rules, 1971, the Employer is obliged to pay any amounts of wages to a workman employed by the Contractor in execution of the works, or to incur any expenditure in providing welfare and health amenities required to be provided under the above said Act and the rules under Clause 19H or under the Rules framed by Government from time to time for the protection of health and sanitary arrangements for workers employed by Contractor, the Employer will recover from the Contractor, the amount of wages so paid or the amount of expenditure so incurred; and without prejudice to the rights of the Employer under sub-section(2) of Section 20, and sub-section (4) of Section 21, of the Contract Labour (Regulation and Abolition) Act, 1970, the Employer shall be at liberty to recover such amount or any part thereof by deducting it from the Security Deposit or from any sum due by the Employer to the Contractor whether under this Contract or otherwise the Employer shall not be bound to contest any claim made against in under sub-section (1) of Section 20, sub-section (4) of Section 21, of the said Act, except on the written request of the Contractor and upon his giving to the Employer full security for all costs for which the Employer might become liable in contesting such claim.

Clause 19: Labour Laws to be complied by Contractor

The Contractor shall obtain a valid license under the Contract Labour (R&A) Act, 1970, and the Contract Labour (Regulation and Abolition) Central Rules, 1971, before the

commencement of the work, and continue to have a valid license until the completion of the work. The Contractor shall also abide by the provisions of the Child Labour (Prohibition and Regulation) Act, 1986.

The Contractor shall also comply with the provisions of the building and other Construction Workers (Regulation of Employment & Conditions of Service) Act, 1996 and the building and other Construction Workers Welfare Cess Act, 1996.

Any failure to fulfill these requirements shall attract the penal provisions of this Contract arising out of the resultant non-execution of the work.

Clause 19A

No labour below the age of fourteen years shall be employed on the work.

Clause 19B: Payment of Wages

- i. The Contractor shall pay to labour employed by him either directly or through Subcontractors, wages not less than fair wages as per the provisions of the Contract Labour (Regulation and Abolition) Act, 1970 and the Contract Labour (Regulation and Abolition) Central Rules, 1971, wherever applicable.
- ii. The Contractor shall, notwithstanding the provisions of any Contract to the contrary, cause to be paid fair wage to labour indirectly engaged on the work, including any labour engaged by his Subcontractors in connection with the said work, as if the labour had been immediately employed by him.
- iii. In respect of all labour directly or indirectly employed in the works for performance of the Contractor's part of this Contract, the Contractor shall comply with or cause to be complied with the Contractor's Labour Regulations made by the Employer from time to time in regard to payment of wages, wage period, deductions from wages recovery of wages not paid and deductions unauthorised made, maintenance of wage books or wage slips, publication of scale of wages and other terms of employment, inspection and submission of periodical returns and all other matters of the like nature or as per the provisions of the Contract Labour (Regulation and Abolition) Act, 1970, and the Contract Labour (Regulation and Abolition) Central Rules, 1971, wherever applicable.
- iv. The Engineer-in-Charge concerned shall have the right to deduct from the moneys due to the Contractor any sum required or estimated to be required for making good the loss suffered by a worker or workers by reason of non-fulfilment of the conditions of the Contract for the benefit of the workers, non-payment of wages or of deductions made from his or their wages which are not justified by their terms of the Contract or non-observance of the Regulations.
- v. Under the provision of Minimum Wages (Central) Rules, 1950, the Contractor is bound to allow to the labour directly or indirectly employed in the works one day rest for 6 days continuous work and pay wages at the same rate as for duty. In the event of default, the Engineer-in-Charge shall have the right to deduct the sum or sums not paid on account of wages for weekly holidays to any labour and pay the same to the persons entitled thereto from any money due to the Contractor by the Engineer-in-Charge concerned.
- vi. The Contractor shall comply with the provisions of the Payment of Wages Act, 1936,

- Minimum Wages Act, 1948, Employees Liability Act, 1938, Workmen's Compensation Act, 1923, Industrial Disputes Act, 1947, Maternity Benefits Act, 1961, and the Contractor's Labour (Regulation and Abolition) Act 1970, Employees Provident Fund & miscellaneous provisions act 1952, Employees state insurance act 1948 or the modifications thereof or any other laws relating thereto and the rules made thereunder from time to time.
- vii. The Contractor shall indemnify and keep indemnified the Employer against payments to be made under and for the observance of the laws aforesaid without prejudice to his right to claim indemnity from his sub- Contractors.
 - viii. The laws aforesaid shall be deemed to be a part of this Contract and any breach thereof shall be deemed to be a breach of this Contract.
 - ix. Whatever is the minimum wage for the time being, or if the wage payable is higher than such wage, such wage shall be paid by the Contractor to the workmen directly without the intervention of Jamadar and that Jamadar shall not be entitled to deduct or recover any amount from the minimum wage payable to the workmen as and by way of commission or otherwise. The Contractor shall ensure that no amount by way of commission or otherwise is deducted or recovered by the Jamadar from the wage of workmen.

Clause 19C: Safety Provisions for Labour and Penalty on Default

In respect of all labour directly or indirectly employed in the work for the performance of the Contractor's part of this Contract, the Contractor shall at his own expense arrange for the safety provisions as per Safety Code framed from time to time and shall at his own expense provide for all facilities in connection therewith. In case the Contractor fails to make arrangement and provide necessary facilities as aforesaid, he shall be liable to pay a penalty of Rs.200/- for each default and in addition, the Engineer-in-Charge shall be at liberty to make arrangement and provide facilities as aforesaid and recover the costs incurred in that behalf from the Contractor.

Clause 19 D: Submission of Labour Chart by every fortnight

The Contractor shall submit by the 5th and 20th of every month, to the Engineer-in-Charge, a true statement showing in respect of these and half of the preceding month and the first half of the current month respectively:

- (1) The number of labourers employed by him on the work,
- (2) Their working hours,
- (3) The wages paid to them,
- (4) The accidents that occurred during the said fortnight showing the circumstances under which they happened and the extent of damage and injury caused by them, and
- (5) The number of female workers who have been allowed maternity benefit according to Clause 19F and the amount paid to them. Failing which the Contractor shall be liable to pay the Employer, a sum not exceeding Rs.200/- for each default or materially incorrect statement. The decision of the Engineer-in-Charge shall be final in deducting from any bill due to the Contractor; the amount levied as fine and be binding on the Contractor.

Clause 19 E: Health and Sanitary Arrangements for workers

In respect of all labour directly or indirectly employed in the works for the performance of the Contractor's part of this Contract, the Contractor shall comply with or cause to be complied with all the rules framed by the Government from time to time for the protection of health and sanitary arrangements for workers employed by the Employer and its Contractors.

Clause 19F: Maternity Benefit rules:

Leave and pay during leave shall be regulated as follows:

1. Leave:

- (i) In the case of delivery-maternity leave not exceeding 8 weeks, 4 weeks up to and including the day of delivery and 4 weeks following that day,
- (ii) In the case of miscarriage-upto 3 weeks from the date of miscarriage.

2. Pay:

- (i) In the case of delivery-leave pay during maternity leave will be at the rate of the women's average daily earnings, calculate total wages earned on the days when full time work was done during a period of three months immediately preceding the date on which she gives notice that she expects to be confined.
- (ii) In the case of miscarriage-leave pay at the rate of average daily earning calculated on the total wages earned on the days when full time work was done during a period of three months immediately preceding the date of such miscarriage.

3. Conditions for the grant of Maternity Leave:

No maternity leave benefit shall be admissible to a woman unless she has been employed for a total period of not less than six months immediately preceding the date on which she proceeds on leave.

4. The Contractor shall maintain a register of Maternity (Benefit) in the Prescribed Form as shown in appendix-I and II, and the same shall be kept at the place of work.

Clause 19G: Penalty for Non-Compliance for Labour Regulation

In the event of the Contractor(s) committing a default or breach of any of the provisions of the Employer, Contractor's Labour Regulations and Model Rules for the protection of health and sanitary arrangements for the workers as amended from time to time or furnishing any information or submitting or filing any statement under the provisions of the above Regulations and Rules which is materially incorrect, he/ they shall, without prejudice to any other liability, pay to the Government a sum not exceeding Rs.200/-for every default, breach or furnishing, making, submitting, filing such materially incorrect statements and in the event of the Contractor(s) defaulting continuously in this respect, the penalty maybe enhanced to Rs. 200/- per day for each day of default subject to a maximum of 5 percent of the estimated cost of the work put to tender. The decision of the Engineer-in-Charge shall be final and binding on the parties.

Should it appear to the Engineer-in-Charge that the Contractor(s) is/ are not properly observing and complying with the provisions of the CPWD. Contractor's Labour Regulations and Model Rules and the provisions of the Contract Labour (Regulation and Abolition) Act 1970, and the Contract Labour (R&A) Central Rules 1971, for the protection of health and sanitary arrangements for work-people employed by the Contractor(s) (hereinafter referred as "the said Rules") the Engineer-in-Charge shall have power to give notice in writing to the Contractor(s) requiring that the said Rules be complied with and the amenities prescribed therein be provided to the work-people within a reasonable time to be specified in the notice. If the Contractor(s) shall fail within the period specified in the notice to comply with and/ observe the said Rules and to provide the amenities to the work-people as aforesaid, the Engineer-in-Charge shall have the power to provide the amenities herein before mentioned at the cost of the Contractor(s). The Contractor(s) shall erect, make and maintain at his/ their own expense and to approved standards all necessary huts and sanitary arrangements required for his/ their work-people on the site in connection with the execution of the works, and if the same shall not have been erected or constructed, according to approved standards, the Engineer-in-Charge shall have power to give notice in writing to the Contractor(s) requiring that the said huts and sanitary arrangements be remodeled and/ or reconstructed according to approved standards, and if the Contractor(s) shall fail to remodel or reconstruct such huts and sanitary arrangements according to approved standards within the period specified in the notice, the Engineer-in-Charge shall have the power to remodel or reconstruct such huts and sanitary arrangements according to approved standards at the cost of the Contractor(s).

Clause 19H: Providing Hutments, W/S, S/I, Drainage, Sanitations etc. for workers

The Contractor(s) shall at his/their own cost provide his/their labour with a sufficient number of huts (hereinafter referred to as the camp) of the following specifications on a suitable plot of land to be approved by the Engineer-in-Charge.

(i)

(a) The minimum height of each hut at the eaves level shall be 2.10 m (7ft.) and the floor area to be provided will be at the rate of 2.7 sq.m. (30 sq.ft.) for each member of the worker's family staying with the labourer.

(b) The Contractor(s) shall in addition construct suitable cooking places having a minimum area of 1.80mx1.50m (6'x5') adjacent to the hut for each family.

(c) The Contractor(s) shall also construct temporary latrines and urinals for the use of the labourers each on the scale of not less than four per each one hundred of the total strength, separate latrines and urinals being provided for women.

(d) The Contractor(s) shall construct sufficient number of bathing and washing places, one unit for every 25 persons residing in the camp. These bathing and washing places shall be suitably screened.

(ii)

(a) All the huts shall have walls of sun-dried or burnt-bricks laid in mud mortar or other suitable local materials as may be approved by the Engineer-in-Charge. In case of sun-dried bricks, the

walls should be plastered with mud gobri on both sides. The floor may be kutcha but plastered with mud gobri and shall be at least 15cm (6") above the surrounding ground. The roofs shall be laid with thatch or any other materials as may be approved by the Engineer-in-Charge and the Contractor shall ensure that throughout the period of their occupation, the roofs remain water-tight.

(b) The Contractor(s) shall provide each hut with proper ventilation.

(c) All doors, windows, and ventilators shall be provided with suitable leaves for security purposes.

(d) There shall be kept an open space of at least 7.2m (8yards) between the rows of huts which may be reduced to 6m (20ft.) according to the availability of site with the approval of the Engineer-in-Charge. Back to back construction will be allowed.

(iii) **Water Supply:** The Contractor(s) shall provide adequate supply of water for the use of labourers.

The provisions shall not be less than two gallons of pure and wholesome water per head per day for drinking purposes and three gallons of clean water per head per day for bathing and washing purposes. Where piped water supply is available, supply shall be at stand posts and where the supply is from wells or river, tanks which may be of metal or masonry, shall be provided. The Contractor(s) shall also at his/ their own cost make arrangements for laying pipelines for water supply to his/ their labour camp from the existing mains wherever available, and shall pay all fees and charges therefore.

(iv) The site selected for the camp shall be high ground, removed from jungle.

(v) **Disposal of Excreta-** The Contractor(s) shall make necessary arrangements for the disposal of excreta from the latrines by trenching or incineration which shall be according to the requirements laid down by the Local Health Authorities. If trenching or incineration is not allowed, the Contractor(s) shall make arrangements for the removal of the excreta through the Municipal Committee/ authority and inform it about the number of labourers employed so that arrangements may be made by such Committee/ Authority for the removal of the excreta. All charges on this account shall be borne by the Contractor and paid direct by him to the Municipality/ Authority. The Contractor shall provide one sweeper for every eight seats in case of dry system.

(vi) **Drainage-**The Contractor(s) shall provide efficient arrangements for draining away sullage water so as to keep the camp neat and tidy.

(vii) The Contractor(s) shall make necessary arrangements for keeping the camp area sufficiently lighted to avoid accidents to the workers.

(viii) **Sanitation-**The Contractor(s) shall make arrangements for conservancy and sanitation in the labour camps according to the rules of the Local Public Health and Medical Authorities.

Clause 19I: Removal of incompetent Workers

The Engineer-in-Charge may require the Contractor to dismiss or remove from the site of the work any person or persons in the Contractors' employ upon the work who may be incompetent

or misconduct himself and the Contractor shall forthwith comply with such requirements.

In respect of maintenance/repair or renovation works etc. where the labour have an easy access to the individual houses, the Contractor shall issue identity cards to the labourers, whether temporary or permanent and he shall be responsible for any untoward action on the part of such labour. The Engineer-in-Charge will display a list of Contractors working in the colony/Blocks on the notice board in the colony and also at the service centre, to apprise the residents about the same.

Clause 19J: No part of building to be occupied- action on breach thereof

It shall be the responsibility of the Contractor to see that the building under construction is not occupied by anybody unauthorizedly during construction, and is handed over to the Engineer-in-Charge with vacant possession of complete building. If such building though completed is occupied illegally, then the Engineer-in-Charge shall have the option to refuse to accept the said building/ buildings in that position. Any delay in acceptance on this account will be treated as the delay in completion and for such delay, a levy upto 5% of tendered value of work may be imposed by the Employer whose decision shall be final both with regard to the justification and quantum and be binding on the Contractor.

However, the Employer, through a notice, may require the Contractor to remove the illegal occupation any time on or before construction and delivery.

Clause 19K: Employment of Skilled/Semi-Skilled Workers

The Contractor shall, at all stages of work, deploy skilled/ semi-skilled tradesmen who are qualified and possess certificate in particular trade from Industrial Training Institute/ National Institute of construction Management and Research (NICMAR)/ National Academy of Construction, CIDC or any similar reputed and recognized Institute managed/ certified by State/ Central Government. The number of such qualified tradesmen shall not be less than 20% of total skilled/ semi-skilled workers required in each trade at any stage of work. The Contractor shall submit number of man days required in respect of each trade, it's scheduling and the list of qualified tradesmen along with requisite certificate from recognized Institute to Engineer-in-Charge for approval. Notwithstanding such approval, if the tradesmen are found to have in adequate skill to execute the work of respective trade, the Contractor shall substitute such tradesmen within two days of written notice from Engineer-in-Charge. Failure on the part of Contractor to obtain approval of Engineer-in-Charge or failure to deploy qualified tradesmen will attract a compensation to be paid by Contractor at the rate of Rs. 600 per such tradesman per day. Decision of Engineer-in-Charge as to whether particular tradesman possesses requisite skill and amount of compensation in case of default shall be final and binding.

Provided always, that the provisions of this clause, shall not be applicable for works with estimated cost put to tender being less than Rs.5 Crores.

For work costing more than Rs. 10 Crores, and upto Rs. 50 Crores, the Contractor shall arrange on site training as per National Skill Development Corporation (NSDC) norms for at least 20% of the unskilled workers engaged in the project in co-ordination with the Employer & National

Skill Development Corporation (NSDC) for certification at the level of skilled/semi-skilled tradesmen.

For works costing more than Rs. 50 Crores, the Contractor shall arrange on site training as per National Skill Development Corporation (NSDC) norms for at least 30% of the unskilled worker engaged in the project in co-ordination with the Employer & National Skill Development Corporation (NSDC) for certification at the level of skilled/semi-skilled tradesmen. The cost of such training as stated above shall be borne by the Government. The necessary space and workers shall be provided by the Contractor and no claim what so ever shall be entertained.

Clause 20: Minimum Wages act to be complied with

The Contractor shall comply with all the provisions of the Minimum Wages Act, 1948, and Contract Labour (Regulation and Abolition) Act, 1970, amended from time to time and rules framed thereunder and other labour laws affecting Contract labour that may be brought into force from time to time.

Clause 21: Work not to be Sublet/Action in Case of Insolvency

The Contract shall not be assigned or sublet without the written approval of the Engineer-in-Charge. And if the Contractor shall assign or sublet his Contract, or attempt to do so, or become insolvent or commence any insolvency proceedings or make any composition with his creditors or attempt to do so, or if any bribe, gratuity, gift, loan, perquisite, reward or advantage pecuniary or otherwise, shall either directly or indirectly, be given, promised or offered by the Contractor, or any of his servants or agent to any public officer or person in the employment of WAPCOS Limited in any way relating to his office or employment, or if any such officer or person shall become in any way directly or indirectly interested in the Contract, the Engineer-in-Charge on behalf of the Employer shall have power to adopt the course specified in Clause 3 of GCC hereof in the interest of the Employer and in the event of such course being adopted, the consequences specified in the said Clause 3 of GCC shall ensue.

The Contractor may sub-Contract any portion of specialized work only, with the approval of the Engineer-in-Charge. Sub-contracting does not alter the Contractor's obligations. The sub-contracting Contractor shall be of repute.

Clause 22: Sums payable by way of compensations

All sums payable by way of compensation under any of these conditions shall be considered as reasonable compensation to be applied to the use of the Employer without reference to the actual loss or damage sustained and whether or not any damage shall have been sustained.

Clause 23: Changes in Firm's Constitution to be intimated

Where the Contractor is a partnership firm, the previous approval in writing of the Engineer-in-Charge shall be obtained before any change is made in the constitution of the firm. Where the Contractor is an individual or a Hindu undivided family business concern, such approval as

aforesaid shall likewise be obtained before the Contractor enters into any partnership agreement where under the partnership firm would have the right to carry out the works hereby undertaken by the Contractor. If previous approval as aforesaid is not obtained, the Contract shall be deemed to have been assigned in contravention of Clause 21 of GCC and the same action may be taken, and the same consequences shall ensue as provided in the said Clause 21 of GCC.

Clause 24: Works to be Under Directions of Engineer-in-Charge

All works to be executed under the Contract shall be executed under the direction and subject to the approval in all respects of the Engineer-in-Charge who shall be entitled to direct at what point or points and in what manner they are to be commenced, and from time to time carried on.

The Engineer-in-Charge may delegate any of his duties and responsibilities to other people after notifying the Contractor and may cancel any delegation after notifying the Contractor.

Clause 24A: Life Cycle Cost

The Contractor shall be responsible for safety, quality and soundness of the buildings including structural elements beyond maintenance period. The Contractor shall have obligation to rectify such defects minimum up to 1 (one) years from the date of completion of work. The defects have to be rectified within a reasonable time not exceeding forty-five days after issue of notice by Engineer-in-Charge. If Contractor does not take corrective action within 45 days, then action for debarring of the agency shall be taken by the appropriate authority.

Clause 25: Settlement of Disputes & Arbitration Amicable Resolution and Mediation

25.1 Settlement of Disputes

Except where otherwise provided in the contract, all questions and disputes relating to the meaning of the specifications, design, drawings and instructions here-in before mentioned and as to the quality of workmanship or materials used on the work or as to any other question, claim, right, matter or thing whatsoever in any way arising out of or relating to the contract, designs, drawings, specifications, estimates, instructions, orders or these conditions or otherwise concerning the works or the execution or failure to execute the same whether arising during the progress of the work or after the cancellation, termination, completion or abandonment thereof shall be dealt with as mentioned hereinafter:

- i) If the Contractor considers any work demanded of him to be outside the requirements of the Contract, or disputes any drawings, record or decision given in writing by the Engineer-in-Charge on any matter in connection with or arising out of the Contract or carrying out of the work, to be unacceptable, he shall promptly within 15 days request Engineer-in-Charge in writing for written instruction or decision. Thereupon, the Engineer-in-Charge shall give his written instructions or decision within a period of one month from the receipt of the Contractor's letter.
- ii) In case the Contractor is not satisfied with the decision of Engineer-in-Charge, he may proceed for arbitration as detailed in **Clause 25.2** hereinafter.

- iii) It is a term of Contract that each party invoking arbitration must exhaust the aforesaid mechanism of settlement of claims/disputes prior to invoking arbitration.
- iv) Performance of this Agreement/ Contract shall continue during arbitration proceedings or any other dispute resolution mechanism pursuant to Clause 25.2. No payment due or payable by the Employer shall be withheld on account of pending reference to the arbitration or other dispute resolution mechanism except to the extent that such payment of dispute.

25.2 Arbitration

Any dispute, controversy of claims arising out of or relating to this Agreement or the breach, termination or invalidity thereof, shall be settled through following mechanism:

- a. Firstly, the aggrieved party shall write a letter to the other party detailing its grievances and calling upon the other party to amicably resolve the dispute by convening a joint meeting. Accordingly, the parties as per their convenience shall jointly convene the said meeting(s), wherein minutes of the said meeting(s) shall be prepared and countersigned by all the parties. It is mandatory to prepare minutes of meeting(s) and to be countersigned by all the parties, irrespective of the outcome of the said meeting(s).
- b. In the event the parties are unable to reach on any settlement in the said meeting(s), then the aggrieved party shall mandatorily resort to pre-litigation mediation mechanism with Delhi High Court Mediation Cell, New Delhi.
- c. It is only upon failure of the pre-litigation mediation mechanism with Delhi High Court Mediation Cell, then the aggrieved party shall resort to resolution of disputes through arbitration of a Sole Arbitrator. The appointing authority of Sole Arbitrator is CMD, WAPCOS Limited, to which neither of the parties have any objection nor they shall ever object.
- d. Subject to the parties agreeing otherwise, the Arbitration proceedings shall be conducted in accordance with the provisions of the Indian Arbitration and Conciliation Act, 1996 (amended as on date).
- e. It is also acknowledged and accepted that the Employer is only working as intermediary between the Contractor/Supplier and the Principal Employer/Owner/Client, thus in the event, any dispute arises under the present agreement and referred to Arbitration for adjudication, then subject to corresponding clause in the Contract between Principal Employer/Owner/Client & the Employer, Principal Employer/Owner/Client shall also be made party to the said Arbitration proceedings. Also, the award including costs if any passed against the Employer and costs incurred in the proceedings shall be the sole responsibility of Principal Employer/Owner/Client. The said clause if found inapplicable, even then the other terms of the Arbitration Clause shall survive and shall be acted upon.
- f. The place/seat of arbitration shall be Delhi and any award whether interim or final, shall be made, and shall be deemed for all purposes between the parties to be made, in Delhi. The

arbitral procedure shall be conducted in English language and any award or awards shall be rendered in English. The procedural law of the arbitration shall be Indian Law. The award of the arbitrator shall be final and conclusive and binding upon the Parties.

- g. The Contract and any dispute or claim arising out of or in connection with it or its subject matter or formation (including non-contractual disputes or claims) shall be governed by and construed in accordance with the laws of India and the Parties submit to sole & exclusive jurisdiction of courts at Delhi.”

25.3 English Language

The request for arbitration, the answer to the request, the terms of reference, any written submissions, any orders and awards shall be in English and, if oral hearings take place, English shall be the language to be used in the hearings.

25.4 Performance during Arbitration

Pending the submission of and/or decision on a Dispute and until the arbitral award is published, the Parties shall continue to perform their respective obligations under the Contract without prejudice to a final adjustment in accordance with such award.

25.5 No arbitration for decision on sub-standard work

The decision of Engineer-in-Charge regarding the quantum or reduction as well as justification thereof in respect of payment for sub-standard work which maybe decided to be accepted will be final and would not be open to arbitration.

Clause 26: Contractor Indemnify Employer against Patent Rights

The Contractor shall fully indemnify and keep in demnified the Employer against any action, claim or proceeding relating to infringement or use of any patent or design or any alleged patent or design rights and shall pay any royalties which may be payable in respect of any article or part thereof included in the Contract. In the event of any claims made under or action brought against Employer in respect of any such matters as aforesaid, the Contractor shall be immediately notified thereof and the Contractor shall be at liberty, at his own expense, to settle any dispute or to conduct any litigation that may arise therefrom, provided that the Contractor shall not be liable to indemnify the Employer if the infringement of the patent or design or any alleged patent or design right is the direct result of an order passed by the Engineer-in-Charge in this behalf.

Clause 27: Action where no Specifications are specified

In the case of any class of work for which there is no such specifications as referred to in Clause 11 of GCC, such work shall be carried out in accordance with Bureau of Indian Standards Specifications. In case there are no such specifications in Bureau of Indian Standards specifications then the work shall be carried out as per Manufacturers' specifications, if not available then as per District Specifications. In case there are no such

specifications as required above, the work shall be carried out in all respects in accordance with the instructions and requirements of the Engineer-in-Charge.

Clause 28: Withholding and Lien in Respect of Sum Due from Contractor

i) Whenever any claim or claims for payment of a sum of money arises out of or under the Contract or against the Contractor, the Engineer-in-Charge or the Employer shall be entitled to withhold and also have a lien to retain such sum or sums in whole or in part from the security, if any deposited by the Contractor and for the purpose aforesaid, the Engineer-in-Charge or the Employer shall be entitled to withhold the security deposit, if any, furnished as the case may be and also have a lien over the same pending finalization or adjudication of any such claim. In the event of the security being insufficient to cover the claimed amount or amounts or if no security has been taken from the Contractor, the Engineer-in-Charge or the Employer shall be entitled to withhold and have a lien to retain to the extent of such claimed amount or amounts referred to above, from any sum or sums found payable or which may at any time thereafter become payable to the Contractor under the same Contract or any other Contract with the Engineer-in-Charge of the Employer or any contracting person through the Engineer-in-Charge pending finalization of adjudication of any such claim.

It is an agreed term of the Contract that the sum of money or moneys so withheld or retained under the lien referred to above by the Engineer-in-Charge or Employer will be kept withheld or retained as such by the Engineer-in-Charge or the Employer till the claim arising out of or under the Contract is determined by the arbitrator (if the Contract is governed by the arbitration clause) by the competent Employer case maybe and that the Contractor will have no claim for interest or damages whatsoever on any account in respect of such withholding or retention under the lien referred to above and duly notified as such to the Contractor. For the purpose of this clause, where the Contractor is a partnership firm or a limited company, the Engineer-in-Charge or the Employer shall be entitled to withhold and also have a lien to retain towards such claimed amount or amounts in whole or in part from any sum found payable to any partner/ limited company as the case maybe, whether in his individual capacity or otherwise.

ii) Employer shall have the right to cause an audit and technical examination of the works and the final bills of the Contractor including all supporting vouchers, abstract, etc., to be made after payment of the final bill and if as a result of such audit and technical examination any sum is found to have been over paid in respect of any work done by the Contractor under the Contract any work claimed to have been done by him under the Contract and found not to have been executed, the Contractor shall be liable to refund the amount of over-payment and it shall be lawful for Employer to recover the same from him in the manner prescribed in sub-clause (i) of this clause or in any other manner legally permissible; and if it is found that the Contractor was paid less than what was due to him under the Contract in respect of any work executed by him under it, the amount of such under payment shall be duly paid by Employer to the Contractor, without any interest thereon whatsoever.

Provided that the Employer shall not be entitled to recover any sum overpaid, nor the Contractor shall be entitled to payment of any sum paid short where such payment has been agreed upon between the Employer on the one hand and the Contractor on the other under any term of the Contract permitting payment for work after assessment by Employer.

Clause 29: Lien in Respect of Claims in Other Contracts

Any sum of money due and payable to the Contractor (including the Security Deposit returnable to him) under the Contract maybe withheld or retained by way of lien by the Engineer-in-Charge or the Employer or any other contracting person or persons through Engineer-in-Charge against any claim of the Engineer-in-Charge or the Employer or such other person or persons in respect of payment of a sum of money arising out of or under any other Contract made by the Contractor with the Engineer-in-Charge or the Employer or with such other person or persons.

It is an agreed term of the Contract that the sum of money so withheld or retained under this clause by the Engineer-in-Charge or the Employer will be kept withheld or retained as such by the Engineer-in-Charge or the Employer or till his claim arising out of the same Contract or any other Contract is either mutually settled or determined by the arbitration clause or by the competent court, as the case may be and that the Contractor shall have no claim for interest or damages whatsoever on this account or on any other ground in respect of any sum of money withheld or retained under this clause and duly notified as such to the Contractor.

Clause 30: Water for Works

The Contractor(s) shall make his/their own arrangements for water required for the work and nothing extra will be paid for the same. This will be subject to the following conditions:

- (i) That the water used by the Contractor(s) shall be fit for construction purposes to the satisfaction of the Engineer-in-Charge.
- (ii) The Engineer-in-Charge shall make alternative arrangements for supply of water at the risk and cost of Contractor(s) if the arrangements made by the Contractor(s) for procurement of water are in the opinion of the Engineer-in-Charge, unsatisfactory.

Clause 31: Levy/ Taxes Payable by Contractor

- (i) The Contract price is inclusive of Goods and Service Tax (GST) and any other taxes, levies, royalties together with all general risks, liabilities and obligations set out or implied in the Contract, applicable Labour Cess, cost of insurance to this Contract, all applicable tax liabilities, Income Tax & Surcharges, etc. However, only the payment of GST shall be reimbursed by the Employer to the Contractor as per procedure laid down in sub-clause (ii) of this clause.
- (ii) The Contractor shall issue Tax Invoices to Employer showing (i) Basic Amount (ii) GST Amount separately for each running account bill including final bill and the payment of GST amount shall be reimbursed to the Contractor only after uploading of GST amount by Contractor on GST portal to avail input benefit of GST by Employer.
- (iii) Notwithstanding anything contained in clause 31 (i & ii), the Contractor shall ensure payment of appropriate tax on the supplies made under the Contract. The Contractor shall comply with all applicable provision of Goods and Service Tax (GST) levied by Union Government and State Governments. The Contractor shall get himself registered

and discharge his obligations for payment of taxes, filing of returns etc. under the appropriate provisions of law in respect of all the taxes, duties, levies, cess, etc. The Employer would have right to seek necessary evidence that the Contractor is registered under the law and duly discharging its obligations under the tax law, enabling the Employer to avail input tax credit.

- (iv) In case any law requires the Employer to pay tax on the Contract price on reverse charge basis, the amount of tax deposited by Employer would be considered as paid to the Contractor and, accordingly, the price payable to the Contractor would stand reduced to that extent.
- (v) In case the Contractor does not deposit the tax payable on execution of the Contract, or has not provided the tax invoice to Employer showing the amount of tax, or has not uploaded the document in computerized tax network as per prevailing law, leading to non-availability of inputs credit of the tax to Employer, the amount equivalent to such tax shall be deducted from the any amount payable to Contractor.
- (vi) The Employer shall deduct royalty charges from each running account bill including final bill of Contractor as per the rules of State Government at rates prevailing at the time of execution and deposit the same to the Government. The royalty charges shall be applicable for the material i.e. red bajri, stone, kankar, sand, moorum, etc. or any other materials as per the rules of State government. The Contractor shall obtain necessary permit from local authorities, if required.

If pursuant to or under any law, notification or order any royalty, cess or the like becomes payable by the Employer and does not any time become payable by the Contractor to the State Government, Local authorities in respect of any material used by the Contractor in the works, then in such a case, it shall be lawful to the Employer and it will have the right and be entitled to recover the amount paid in the circumstances as a foresaid from dues of the Contractor.

Clause 32: Conditions for Reimbursement of Levy/Taxes if Levied after Receipt of Tenders:

- (i) All tendered rates shall be inclusive of all taxes and levies payable under respective statutes. However, if any further new tax or levy or cess is imposed by Statute, after the last stipulated date for the receipt of tender including extensions if any and the Contractor thereupon necessarily and properly pays such taxes/ levies/ cess, the Contractor shall be reimbursed the amount so paid, provided such payments, if any, is not, in the opinion of the Employer attributable to delay in execution of work within the control of the Contractor.

Provided further that for Building and Other Construction Workers Welfare Cess or any tax (other than GST), levy or cess varied or imposed after the last date of receipt of tender including extension if any, any increase shall be reimbursed to the Contractor only if the Contractor necessarily and properly pays such increased amount of taxes/levies/cess.

Provided further that such increase including GST shall not be made in the extended period of contract for which the Contractor alone is responsible for delay as determined by authority for extension of time under provision of contract.

- (ii) The Contractor shall keep necessary books of accounts and other documents for the purpose of this condition as may be necessary and shall allow inspection of the same by a duly authorized representative of the Employer and/or the Engineer-in-Charge and shall also furnish such other information/document as the Engineer-in-Charge may require from time to time.
- (iii) The Contractor shall, within a period of 30 days of the imposition of any such further tax or levy or cess, give a written notice thereof to the Engineer-in-Charge that the same is given pursuant to this condition, together with all necessary information relating thereto.

Clause 33: Termination of Contract on Death of Contractor

Without prejudice to any of the rights or remedies under this Contract, if the Contractor dies, The Engineer-in-charge on behalf of The Employers shall have the option of terminating this Contract without levy of compensation to The Contractor.

Clause 34: Compensation during Warlike Situation

The work (whether fully constructed or not) and all materials, machines, tools, plants, scaffolding, temporary buildings and other things connected therewith shall be at risk of The Contractor until The Work has been delivered to The Engineer-in-charge and a certificate from him to that effect obtained.

In the event of The Work or any materials properly brought to the site for incorporation in The Work being damaged or destroyed in consequence of hostilities or warlike operations, the Contractor shall when ordered (in writing) by The Engineer-in-Charge to remove any debris from the site, collect and properly stack or remove in store all serviceable materials salvaged from The Damaged Work and shall be paid at The Contract Rates in accordance with the provisions of this agreement for The work of clearing the site of debris, stacking or removal of serviceable material and for reconstruction of all Works ordered by The Engineer-in-Charge, such payments being in addition to compensation up to the value of The Work originally executed before being damaged or destroyed and not paid for. In case of works damaged or destroyed but not already measured and paid for, the Compensation shall be assessed by The Engineer-in-Charge up to Rs. 2,00,000/- and by the next higher officer concerned for a higher amount.

The Contractor shall be paid for the damages/destruction suffered and for restoring the material at The Rate based on analysis of rates tendered in accordance with the provisions of The Contract. The Certificate of The Engineer-in-Charge regarding the quality and quantity of materials and the purpose for which they were collected shall be final and binding on all parties

to this Contract. Provided always that no compensation shall be payable for any loss in consequence of hostilities or warlike operations (a) unless the Contractor had taken all such precautions against air raid as are deemed necessary by The A.R.P. (Air Raid Precaution) Officers or The Engineer-in-Charge. (b) for any material etc. not on the site of The Work or for any tools, plant, machinery, scaffolding, temporary buildings and other things not intended for the work.

In the event of The Contractor having to carry out reconstruction as aforesaid, he shall be allowed such extension of time for its completion as is considered reasonable by The Engineer-in-Charge.

Clause 35: Apprentices act Provisions to be complied with

The Contractor shall comply with the provisions of The Apprentices Act, 1961 and their rules and orders issued thereunder from time to time. If he fails to do so, his failure will be a breach of The Contract and The Employer may, in his discretion, cancel the contract. The contractor shall also be liable for any pecuniary liability arising on account of any violation by him of the provisions of the said Act.

Clause 36: Release of Security Deposit after Labour Clearance

Release of Security Deposit of the work shall not be refunded till the Contractor produces a clearance deposit after labour certificate from the Labour Officer. As soon as the work is virtually complete the Contractor shall apply for the clearance certificate to the Labour Officer under intimation to the Engineer-in-Charge. The Engineer-in-Charge, on receipt of the said communication, shall write to the Labour Officer to intimate if any complaint is pending against the Contractor in respect of the work. If no complaint is pending, on record till after 3 months after completion of the work and/or no communication is received from the Labour Officer to this effect till six months after the date of completion, it will be deemed to have received the clearance certificate and the Security Deposit will be released if otherwise due.

In any case even after receipt of the clearance certificate from the labour officer the Security Deposit shall be refunded only in terms of Clause 1A (ii) of GCC.

Clause 37: Employer's Financial Arrangements

“The Contractor acknowledges that under the present Contract agreement, the Employer is only working as intermediary between National Institute of Ayurveda (NIA), Jaipur being Principal Employer/Owner/Client and Contractor. Thus, the Contractor unconditionally acknowledge that the payments under the present Contract shall be made proportionately by the Employer only on back-to-back basis i.e., after 21 days subject to receipt of payment NIA, Jaipur being Principal Employer/Owner/Client. The Contractor also unconditionally agrees that in the event the payment or part thereof, under the present Contract is not received from NIA, Jaipur, then

WAPCOS and/or any of its Employee/Officer shall not be responsible to pay any amount to Contractor. The said condition shall supersede any and all other conditions of Contract/Agreement/Work Order/Arrangement between the parties.”

Clause 38: Early Warning

The Contractor is to intimate The Engineer-in-Charge at the earliest opportunity of specific likely future events or circumstances that may adversely affect The Work, resulting in delay in The Execution. The Engineer-in-charge may require The Contractor to provide an estimate of the expected effect of the future event or circumstance on The Completion Date and direct them to take suitable action to avoid such delay or get a suitable extension to completion date.

The Contractor shall cooperate with The Engineer-in-Charge in making and considering proposals for how the effect of such an event or circumstance can be avoided or reduced by anyone involved in the work and in carrying out any resulting instruction of The Engineer-in-Charge.

Clause 39: Identifying Defects

The Engineers shall check The Contractor's work regularly and notify The Contractor of any Defects that are found. Such checking shall not affect The Contractor's responsibilities. The Engineer-in-charge may instruct The Contractor to search for defects and uncover and test any work that The Engineer-in-Charge considers may have a Defect.

Clause 40: Correction of Defects

40.1 The Engineer-in-charge shall notify the Contractor of any Defects before the end of the Defects Liability Period, which begins at Completion and is defined in the Contract. The Defects Liability Period shall be extended for as long as Defects remain to be corrected.

40.2 Every time notice of a Defect is given; the Contractor shall correct the notified Defect within the time specified by the Engineer-in-Charge's notice. However, no payment shall be released for defective work.

Clause 41: Uncorrected Defects

If The Contractor fails to correct a Defect within the time specified by The Engineer-in-Charge, The Employer shall be entitled to employ and pay other persons to carry out the same. And if such work is deemed by The Engineer-in-Charge to be the work which, in his opinion, The Contractor was liable for at its own expense under The Contract, then all expenses consequent thereon or incidental thereto shall be recoverable from The Contractor by The Engineer-in-Charge from any money due or which may become due to The Contractor.

Clause 42: Payment Certificates

42.1 The Contractor shall submit to The Engineer-in-Charge statements of the value of the work completed.

42.2 The Engineer-in-charge shall check The Contractor's statement as per Clause 7 of GCC and certify the amount to be paid to The Contractor after taking into account any creditor or debit for the month in question, in respect of materials for The work at relevant amounts and under conditions set forth in this Contract document.

42.3 The value of work executed shall include the valuation of Change in Scope (Variation), if any.

42.4 The Engineer-in-charge may exclude any item certified in a previous certificate or reduce the proportion of any item previously certified in any certificate, based on later information.

Clause 43: Time Compensation Events

43.1 The following are Time Compensation Events unless they are caused by the Contractor:

43.2 The Employer does not give access to the site or a part of the Site. If any event would prevent work being completed before the Intended Completion Date, The Intended Completion Date shall be extended. The Contractor will react competently and promptly to the event and shall submit information demonstrating the effect of the Event and the required extended time period for completion.

43.3 The Engineer-in-Charge shall examine the information furnished by the Contractor and shall recommend to The Employer by how much time The Intended Completion Date shall be extended. The Employer shall decide/sanction the required extension of time due to such event, however, no payment/compensation will be given to The Contractor due to such extensions of time.

43.4 The Contractor shall not be entitled to any compensation to the extent that The Employer's interests are adversely affected by The Contract or not having given early warning or not having cooperated with The Engineer-in-Charge.

Clause 44: Termination

44.1 The Employer may terminate The Contract if The Contract causes a fundamental breach of The Contract.

44.2 Fundamental breaches of Contract include, but shall not be limited to the following:

- The Contractor stops work for 28 days when no stoppage of work is shown on the current Programme and the stoppage has not been authorized by The Engineer-in-Charge;
- The Contractor is made bankrupt or goes into liquidation other than for a reconstruction or amalgamation;
- The Engineer-in-Charge gives Notice that failure to correct a particular Defect is a fundamental breach of Contract, and The Contractor fails to correct it within a reasonable period of time determined by The Engineer-in-Charge;
- The Contractor does not maintain secrecy which is required;
- The Contractor has delayed the completion of works by the number of days for which the maximum amount of liquidated damages can be paid as defined in The Contract; and
- If The Contractors, in the judgment of The Employer have engaged in corrupt or fraudulent practices in competing for or executing The Contract.

44.3 For purposes of this paragraph: "corrupt practice" means offering, giving, receiving, or soliciting anything of value to influence the action of a public official in the procurement process in contract execution. "Fraudulent practice" means misrepresentation of facts in order to influence a procurement processor's execution of The Contract to the detriment of The Borrower and includes collusive practices among Bidders (prior to or after Bid submission) designed to establish Bid prices at artificial, non-competitive levels and to deprive The Borrower of the benefits of free and open competition.

44.4 When either party to The Contract gives notice of a breach of contract to The Engineer-in-Charge for a cause other than those listed under Sub-Clause 44.2 in above, The Engineer-in-Charge shall decide whether the breach is fundamental or not.

44.5 Notwithstanding the above, The Employer may terminate The Contract for convenience.

44.6 If the Contract is terminated, The Contractor shall stop work immediately, make the site safe and secure, and leave the Site as soon as reasonably possible.

Clause 45: Payment upon Termination

45.1 If The Contract is terminated because of a fundamental breach of contract by The Contractors, The Engineer-in-Charge shall issue a certificate for the value of the work done less advance payments received up to the date of the issue of the certificate, less other recoveries due in terms of The Contract, less taxes due to be deducted at source as per applicable law and least the percentage to apply to the work not completed as indicated in The Contract. Additional Liquidated Damages shall not apply. If the total amount due to The Employer exceeds any payment due to The Contractors, the difference shall be a debt payable to The Employer.

45.2 If The Contract is terminated at The Employer's convenience, The Engineer-in-Charge shall issue a certificate for the value of the work done less advance payments received up to the date of the certificate, less other recoveries due in terms of The Contract and less taxes due to be deducted at source as per applicable law. No payment shall be made for expenditure towards removal of Equipment, repatriation of The Contractor's personnel employed solely on the Works and The Contractor's costs of protecting and securing the Works.

45.3 All material on the Site, Plant, Equipment, Temporary Works and Works are deemed to be the property of The Employer if The Contract is terminated because of The Contractor's fundamental breach of contract.

Clause 46: Release from Performance

If the Contract is frustrated by the outbreak of war or by any other event entirely outside the control of either the Employer or the Contractors, the Engineer-in-Charge shall certify that the Contract has been frustrated. The Contractor shall make the Site safe and stop work as quickly as possible after receiving this certificate and shall be paid for all work carried out before receiving it and for any work carried out afterwards to which commitment was made.

Clause 47: Insurance of Works Etc.

47.1 Contractor is required to take Contractor's All Risk policy from Nationalized insurance company in the joint name with Employer and bear all costs towards the same for the full period of execution of works including the Defect Liability Period for the full amount of contract against all loss of damage from whatever cause arising other than excepted risks for which he is

responsible under the terms of the contract and in such manner that the Employer and the Contractor are covered during the period of construction of works and/or also covered during the period of Defect Liability for loss or damage.

- a. The Works and the Temporary works to the full value of such works.
- b. The materials, constructional plant, centering, shuttering and scaffolding materials and other things brought to the site for their full value.

Whenever required by Employer, the Contractor shall produce the policy or the policies of insurance and the receipts for payment of the current premium.

47.2 Insurance under Workmen Compensation Act

Contractor is required to take insurance cover under the Workman Compensation Act, 1923 amended from time to time from nationalized insurance company and pay premium charges thereof. Wherever required by Employer the Contractor shall produce the policy or the policies of Insurance and the receipt of payment of the current premiums.

47.3 Third Party Insurance

Contractor is required to take third party insurance cover for an amount of 5% (five percent) of contract value from Nationalized insurance company for insurance against any damage, injury or loss which may occur to any person or property including that of Employer / Owner, arising out of the execution of the Works or Temporary works. Wherever required by Employer the Contractor shall produce the policy or the policies of Insurance and the receipt of payment of the current premiums.

47.4 If The Contractor shall fail to effect and keep in force the insurances referred to above, or any other insurance which he may be required to effect under the terms of The Contract, then and in any such case The Employer on advice of EIC (Engineer-in-Charge) may effect and keep in force any such insurance and pays such premium or premiums as may be necessary for that purpose and from time to time deduct the amount so paid by the Employer as aforesaid from any money due or which may become due to The Contractor, or recover the same as debt due from The Contractor.

47.5 The Contractor shall at all times indemnify Employer and Owner against all claims, damages or compensation under the provision of Payment of wages act-1936, Minimum Wages Act-1948, Employer's liability Act-1938, the workmen's compensation Act-1947, Industrial Disputes Act-1947 and Maternity Benefit Act-1961 or any modifications thereof or any other law in force or as consequence of any accident or injury to any workman or other persons in or about the works, whether in the employment of the Contractor or not, against all costs, charges and expenses of any suit, action or proceedings arising out of such incident or injury and against all sum or sums which may with the consent of the Contractor be paid to compromise or compound any such claim. Without limiting his obligations and liabilities as above provided, the Contractor shall insure against all claims, damages or compensation payable under the Workmen's Compensation Act 1923 or any modification thereof or any other law relating thereto.

47.6 The Contractor, in case of re-building or reinstatement after fire, shall be entitled to such

extension of time for completion as the EIC may deem fit, but shall, however not be entitled to reimbursement by the Employer or any shortfall or deficiency in the amount finally paid by the Insurer in settlement of any claim arising as set out herein.

Clause 48: Possession of the Site:

The Employer shall give possession of relevant parts of the Site to The Contractor within 7 days from the date of commencement of work to enable them to commence and proceed with the Work in accordance with the Programme of Clause – 5 of GCC. If possession of a part is not given by the time stated, the work programme will be rescheduled based on the delay of possession of site and extension of time considered accordingly. However, no payment/compensation shall be given to The Contractor for such extension.

Furthermore, if and to the extent that the delay of possession of site caused by any error or delay by The Contractor, including an error in or delay in the submission of, any of the Contractor's Documents, The Contractor shall not be entitled to such extension of time and any payment.

Clause 49: Contractor's Storage and Site Office

The Contractor shall make own arrangement for storing his equipment, plant, materials etc. and for his site office and cement godown. The Contractor be solely responsible for watching or guarding his property and materials. Contractor shall cover all materials at site with requisite insurance against theft, larceny, dacoits, fire tempest and flood. The Contractor, however, shall have to dismantle the shed and vacate the land after the receipt of due notice from the Engineer-in-Charge if the same is obstructing any work. The Contractor should obtain necessary permission / approval from Statutory Authorities such as Municipal corporations / Local bodies etc. for construction of temporary structures at site of work such as cement godown, stores, site office etc. It will be responsibility of the Contractor to prepare proper plans, to pay any requisite fees to statutory authorities and to execute the work for the temporary structure at their own cost as per the conditions and rules laid by statutory authorities.

Clause 49A:

Furnished office Accommodation & Mobility and Communication to be provided by Contractor to WAPCOS

On account of furnished Project office equipped with all facilities such as telephone, fax, internet, photocopier, computer/ laptop & printer along with operator, regular electric & purified drinking water supply and inspection vehicle etc. as per the requirement of the project an amount equal to 2.00% of gross bill from all running account & final bill will be recovered.

The contractor shall also make sufficient arrangement for Photography/Videography preferably by maintaining a camera/video camera at site so that video and photographs can be taken of a specific activity at any point of time. The contractor shall also provide software like MS Project, etc. for the purpose of preparing progress report etc.

Clause 50: If Relative Working in WAPCOS then the Contractor not allowed to Tender

The Contractor shall not be permitted to tender for works where The Employer responsible for award and execution of contracts and his near relative is posted in WAPCOS Limited. He shall also intimate the names of persons who are working with him in any capacity or are subsequently employed by him and who are near relatives to any Officer in the Employer's office. Any breach of this condition by The Contractor would render him liable to be barred from tendering in WAPCOS Limited.

NOTE: By the term "near relatives" is meant wife, husband, parents, grandparents, children, grandchildren, brothers, sisters, uncles, aunts and cousins and their corresponding in-laws.

Clause 51: No Gazetted Engineer to Work as Contractor within one Year of Retirement

No Engineer of gazetted rank or other gazetted officer employed in engineering or administrative duties in an engineering department of the Government of India shall work as a Contractor or employee of a Contractor for a period of one year after his retirement from government service without the previous permission of Government of India in writing. This Contract is liable to be cancelled if either the Contractor or any of his employees is found at any time to be such a person who had not obtained the permission of Government of India as aforesaid, before submission of the tender or engagement in the Contractor's service, as the case may be.

Clause 52: Environmental Mitigation Measures during Construction

Sl. No.	Environmental Impact/Issue	Mitigation / Management Measures	Responsibility	
			Implementati on	Supervisio n
1.	Removal of Trees	Trees shall be removed from the site before the commencement of construction with prior clearance from the Forest Department.	Contractors	Engineer-in- Charge
2.	Generation of Debris	Debris generated due to the dismantling of the existing pavement structure shall be suitably reused in the proposed construction, subject to the suitability of the material and the approval of the Engineer-in-Charge. Un-utilizable debris material shall be suitably disposed off by the Contractors; either for the filling up of borrow areas created for the project or at pre-designated dump locations.	Contractors	Engineer-in-Charge
3.	Loss of Topsoil	(a) The topsoil from all areas of cutting and all areas to be permanently covered shall be stripped to a specified depth of 150 mm and stored in stockpiles	Contractors	Engineer-in- Charge

		<p>(maximum slope 1:2, and maximum height 2m). To retain soil and to allow percolation of water, the edges of the stockpile shall be protected by stilt fencing.</p> <p>(b) Stockpiles will not be surcharged or otherwise loaded and multiple handling will be kept to a minimum to ensure that no compaction will occur. It shall be ensured by the Contractor that the topsoil will not be unnecessarily trafficked either before stripping or when in stockpiles.</p> <p>(c) Such stockpiled topsoil will be returned to cover the disturbed area and cut slopes. Residual topsoil will be distributed on adjoining/ proximate barren/rocky areas as identified by the Engineer-in-Charge in a layer of thickness of 75 – 150 mm. Top soil shall also be utilized for redevelopment of borrow areas, landscaping along slopes, medians, incidental spaces etc.</p>		
4.	Borrowing of Earth	The borrowing shall not be carried out in cultivable lands, unless agreed upon by the Engineer-in-Charge. Borrowing of earth shall be carried out as per the IRC Guidelines	Contractors	Engineer-in-Charge
5.	Degradation of Borrow Areas	The location, shape and size of the designated borrow areas shall be as approved by the Engineer-in-Charge and in accordance to the IRC recommended practice for borrow pits for road embankments. Borrow pits shall be re-developed, spoils shall be dumped with an overly of stock piled topsoil. Redevelopment of borrow areas shall be taken up in accordance with the plans approved by the Engineer-in-Charge.	Contractors	Engineer-in- Charge
6.	Soil Erosion	Long sections abutting water bodies, stone pitching needs to be carried out for slopes between 1:4 and 1:2 Gabion structures/ Grass turving shall be provided for slopes steeper than 1 vertical to 2 horizontal. The work shall consist of measures as per design or as directed by the Engineer-in-Charge to control soil erosion, sedimentation and water pollution, through use of berms, dikes, sediment basins, fiber mats,	Contractors	Engineer-in- Charge

		mulches, grasses, slope drains and other devices.		
7.	Construction Wastes & their disposal	Spoil from excavation of riverbed shall be managed and disposed off as directed by the Engineer-in-Charge. No new disposal site shall be created as part of the project, which is not redeveloped. All waste material shall be completely disposed as desired and the site shall be fully cleaned before handing over.	Contractors	Engineer-in- Charge
8.	Loss of Water Bodies	a. Filling of surface water bodies shall be compensated by digging an equal volume of soil for water storage. Such dug-up soil shall be used for spreading as topsoil. b. Wherever earthwork is undertaken, the banks shall be protected by means as designed or as approved by the Engineer-in-Charge. Construction shall be carried out in a manner so that the side slopes are no steeper than 1:4, otherwise slope protection work shall be provided, as approved by the Engineer-in-Charge and as per item 6 of these Specifications. For drains carrying run-off from the Highways entering, into surface water bodies/ channels, with a fall or sedimentation traps shall be provided.	Contractors	Engineer-in- Charge
9.	Loss of Other Water Sources	The replacement shall be ready prior to demolition / dismantling of the existing source. Any damage to the existing sources of water (hand pump, tube well etc.) shall be made good by the Contractor at his expense.	Contractors	Engineer-in-Charge
10.	Flooding	In addition to the design requirements, the Contractor shall take all desired measures as directed by the Engineer-in-Charge to prevent temporary or permanent flooding of the site or any adjacent area.	Contractors	Engineer-in- Charge

11.	Alteration of Drainage	<p>a. In sections along water courses, and close to cross- drainage channels, earth, stone or any other construction materials or appendage shall be properly disposed off so as not to block the flow of water.</p> <p>b. All necessary measures shall be taken to prevent earthwork, stonework, materials and appendage as well as the method of operation from impending cross-drainage at rivers, streams, water canals and existing and existing irrigation and drainage systems.</p>	Contractors	Engineer-in- Charge
12.	Contamination from Construction Wastes, fuel and Lubricants	At construction vehicle parking locations and at fuel/ lubricant storage sites, oil and grease traps shall be provided. Fuel storage shall be in proper bounded areas. The discharge standards promulgated under the Environmental Protection Act, 1986 shall be strictly adhered to.	Contractors	Engineer-in- Charge
13.	Sanitation and Waste disposal in construction camps	Construction labourer's camps shall be located at least 200 m away from the nearest habitation and as approved by the Engineer- in-Charge. The sewage system for a construction labourer's camp shall be designed, Build and as per the Factories Act, 1948 and the Building and other Construction Workers (Regulation of Employment and Conditions of Service) Act, 1996.	Contractors	Engineer-in- Charge
14.	Generation of Dust	All vehicles delivering materials to the site shall be covered to avoid spillage of materials. Cleaning shall be affected by manual sweeping and removal of debris, or, if so directed by the Engineer-in-Charge, by mechanical sweeping and cleaning equipment, and all dust, mud and other debris shall be removed completely. Anti-smog gun may be deployed as and when necessary.	Contractors	Engineer-in- Charge
15.	Emission from Hot-Mix Plants and Batching Plants	Hot mix plants and batching plants shall be located sufficiently away from habitation, agricultural operations or industrial establishments. Where possible such plants will be located at least 1000 m downwind from the nearest habitation. The exhaust gases, and operation of the plants shall comply with the requirements of the relevant current emission control rules.	Contractors	Engineer-in- Charge

16.	Emission and noise from Vehicles & Equipment	All vehicles, equipment and machinery used for construction shall conform to the relevant Bureau of Indian Standard (BIS) norms. All vehicles, equipment and machinery used for construction shall be regularly maintained to ensure that pollution emission levels comply with the relevant requirements of concerned pollution governing body under State Government.	Contractors	Engineer-in- Charge
17.	Pollution from Crusher	All crushers used in construction shall conform to relevant dust emission control rules. Clearance for sitting shall be obtained from the concerned local Body. Alternatively, only crushers already licensed by the concerned local Body.	Contractors	Engineer-in- Charge
18.	Loss, Damage or Disruption of/to Fauna	All works are to be carried out in such a fashion that the damage and disruption to fauna is minimum. Construction workers shall be instructed to protect natural resources and fauna, including wild animals and aquatic life. Hunting and unauthorized fishing are prohibited.	Contractors	Engineer-in- Charge
19.	Chance-found Important Flora/ Fauna	If a rare/endangered/ threatened flora/fauna species is spotted, the Contractor shall make all arrangements to intimate the Forest/Wildlife authorities without delay, and measures will be taken for its conservation. Work would be suspended, until the relevant authorities are consulted, unless specifically directly by the Engineer-in-Charge.	Contractors	Engineer-in- Charge
20.	Traffic Control and Safety	The Contractor shall take all necessary measures for the safety of traffic during construction and provide, erect and maintain such barricades, including signs, markings, flags, lights and flagmen as may be required by the Engineer-in-Charge for the information and protection of traffic approaching or passing through the section of the road under improvement.	Contractors	Engineer-in- Charge

21.	Risk from Construction operations	The Contractor is required to comply with all the precautions as required for the safety of the work men as per the International Labour Organization (ILO) Convention No. 62 as far as those are applicable to this Contract. The Contractor shall also comply with the national Building Code for this purpose.	Contractors	Engineer-in- Charge
22.	Potable Water and Hygiene Building	Potable water supply will be provided, at every work place, as per the Factory Rules of State Government. All requirements as per standards set by the Building and other Construction Workers (Regulation of Employment and Conditions of Service) Act, 1996 shall be fulfilled.	Contractors	Engineer-in- Charge
23.	Protection of Cultural Heritage / Property	All the necessary and adequate care shall be taken to minimize impact on cultural properties (which includes cultural sites and remains, places of worship, graveyards, monuments and any other important properties/sites/remains notified under the Ancient Sites and Remains Act).	Contractors	Engineer-in- Charge
24.	Chance found Geological or Archaeological property	All fossils, coins, articles of value of antiquity and structures and other remains or things of geological or archaeological interest discovered on the site shall be the property of the Employer. The Contractor shall stop all work within 100m in all directions from the findings. The Engineer- in-Charge shall seek direction from the Archaeological Society of India (ASI) before instructing the Contractor to recommence work on the site.	Contractors	Engineer-in- Charge
25.	Risk from explosives	Except as may be provided in the Contract or ordered or authorized by the Engineer-in-Charge, the Contractor shall not use Explosives. Where the use of explosives is so provided or ordered or authorized, the Contractor shall comply with the requirements of the explosives Act. First aid and medical care shall be provided, as per the factory Rules of State Government.	Contractors	Engineer-in- Charge

Clause 53: Preference to make in India

- The provisions of revised 'Public Procurement (Preference to Make in India) Order 2017-Revision' issued by Department of Industrial Policy and Promotion under Ministry of Commerce and Industry vide letter no.-P45021/2/2017-PP (BE-II) as amended on 16.09.2020 shall be applicable to the bidding process and award of the contract shall be done accordingly.
- Verification of Local Content
 - i. The bidder at the time of tender, bidding or solicitation shall be required to indicate percentage of local content and provide self-certification that the item offered meets the local content requirement of the tender. They shall also give details of the location(s) at which the local value addition is made.
 - ii. In cases of procurement for a value in excess of Rs 10 Crores, the bidder shall be required to provide a certificate from the statutory auditor or cost auditor of the company (in the case of companies) or from a practicing cost accountant or practicing chartered accountant (in respect of suppliers other than companies) giving the percentage of local content. The Contractor shall submit a certificate/Undertaking giving the percentage of local content accordingly at Annexure -21

Clause 54: Rule 144 (xi) in General Financial Rules (GFRs) 2017

- i. Any bidder from a country which shares a land border with India will be eligible to bid in this tender only if the bidder is registered with the Competent Authority.
- ii. "Bidder" (including the term 'tenderer', 'consultant' or 'service provider' in certain contexts) means any person or firm or company, including any member of a consortium or joint venture (that is an association of several persons, or firms or companies), every artificial juridical person not falling in any of the descriptions of bidders stated hereinbefore, including any agency branch or office controlled by such person, participating in a procurement process.
- iii. "Bidder from a country which shares a land border with India" for the purpose of this Order means:-
 - a) An entity incorporated, established or registered in such a country; or
 - b) A subsidiary of an entity incorporated, established or registered in such a country; or
 - c) An entity substantially controlled through entities incorporated, established or registered in such a country; or
 - d) An entity whose beneficial owner is situated in such a country; or
 - e) An Indian (or other) agent of such an entity; or
 - f) A natural person who is a citizen of such a country; or
 - g) A consortium or joint venture where any member of the consortium or joint venture falls under any of the above
- iv. The beneficial owner for the purpose of clause 54 (iii) above will be as under:
 1. In case of a company or Limited Liability Partnership, the beneficial owner is the natural person(s), who, whether acting alone or together, or through one or more juridical person, has a controlling ownership interest or who exercise control through other means.
Explanation-
 2. "Controlling ownership interest" means ownership of or entitlement to more than twenty- five per cent. Of shares or capital or profits of the company;

3. "Control" shall include the right to appoint majority of the directors or to control the management or policy decisions including by virtue of their shareholding or management rights or shareholders agreements or voting agreements;
 4. In case of a partnership firm, the beneficial owner is the natural person(s) who, whether acting alone or together, or through one or more juridical person, has ownership of entitlement to more than fifteen percent of capital or profits of the partnership;
 5. In case of an unincorporated association or body of individuals, the beneficial owner is the natural person(s), who, whether acting alone or together, or through one or more juridical person, has ownership of or entitlement to more than fifteen percent of the property or capital or profit of such association or body of individuals;
 6. Where no natural person is identified under (1) or (2) or (3) above, the beneficial owner is the relevant natural person who holds the position of senior managing official;
 7. In case of a trust, the identification of beneficial owner(s) shall include identification of the author of the trust, the trustee, the beneficiaries with fifteen percent or more interest in the trust and any other natural person exercising ultimate effective control over the trust through a chain of control or ownership.
- v. An Agent is a person employed to do any act for another, or to represent another in dealings with third person.

The successful bidder shall not be allowed to sub-contract works to any contractor from a country which shares a land border with India unless such contractor is registered with the Competent Authority.

In such case, the bidder shall submit an undertaking as per annexure-22.

Clause 55: Other Conditions

1. The Contractor shall deploy the resources at site to start the construction after written approval from Employer. No claim shall be entertained for idle of labour, idle machinery, idle technical / non-technical staff, idle T&P if any, due to delay in start of the works. If any dispute/ hindrance may arise during construction due to any reason whatsoever, the Contractor is not liable for any financial claim or damages due to such circumstances.
2. The efforts will be made by the employer to handover the site to the Contractor free of encumbrances. However, in case of any delay in handing over of the site to the Contractor, the employer shall only consider suitable extension of time for the execution of the work. It should be clearly understood that the employer shall not consider any revision in contract price or any other compensation whatsoever viz. towards idleness of Contractor's labour, equipment etc.
3. If required, the contractor has to do site clearance, enabling work, barricading, diversion of Roads, shifting/ realignment of existing utility services, drains, nallahs etc. at his own cost as per direction of Engineer-in-charge and the contractor shall not be entitled for any extra payment whatsoever in this regard.
4. The information about the public utilities (whether over ground or underground) like electrical/ telephone/ water supply lines, OFC Cables, open drain etc. is the responsibility of contractor to ascertain the utilities that are to be affected by the works through the site investigation and collection of information from the concerned utility.

The Contractor shall render all help and assistance in documenting the total sequence of this project by way of photography, slides, etc. nothing extra shall be payable to the agency on this account.

5. The Contractor shall make his own arrangements for obtaining electric connection and water Connection/arrangement (if required). The water charges and electricity charges as charged by the Owner and Local Authorities shall be borne by the Contractor. No dispute in this regard shall be entertained.
6. The Contractor shall dispose of all the dismantled materials, debris, garbage, waste outside of the campus of the works at his own cost and provide clear and clean site at the time of handing over the works
7. Contractor shall not divert any advance payments or part thereof for any work other than that needed for completion of the contracted work. All advance payments received as per terms of the contract (i.e., mobilization advance, secured advance against materials brought at site, secured advance against plant & machinery and/or for work done during interim stages, etc.) are required to be re-invested in the contracted work to ensure advance availability of resources in terms of materials, labour, plant & machinery needed for required pace of progress for timely completion of work.
8. The Contractor shall follow & maintain all statutory norms in respect of safety to Workwomen, Model Health Rules, Contractor Labour Regulations. WAPCOS shall not be responsible in case for violation of any statutory/local bodies rules & regulations by the Contractor.

SECTION-V

Technical Specifications

SECTION-V TECHNICAL SPECIFICATIONS

Civil Works

1. General

The execution agency shall be responsible for furnishing all materials required for execution of the Works. The execution agency shall submit the source and method of execution for the Consultant/ Employer's review before any execution. All materials used in the construction of permanent works required under this Contract shall be of 1st class quality as specified herein and comply with the latest IS Codes or equivalent. The material shall be tested before bringing it to the site.

This specification establishes and defines the requirements of various materials to be used in Civil, Structural and Interior works. Whenever any reference to IS Codes is made, the same shall be taken as the latest revision (with all amendments issued thereto) as on the date of submission of the Tender. Apart from the IS Codes mentioned in particular in various clauses of this specification, all other relevant codes related to specific job under consideration regarding quality, tests, testing and/ or inspection procedures shall be applicable. Reference to some of the codes in various clauses of this specification does not limit or restrict the scope of applicability of other referred or relevant codes. In case of any variation/ contradiction between the provision of IS Codes and this section, the provision given in this section shall be followed, unless the Employer agrees/ consents to follow IS codes or other proposal of the Execution agency as provided in the Contract.

All materials shall be of standard quality and shall be procured from renowned sources/ manufacturers approved by the Consultant/ Employer. It shall be the responsibility of the Execution agency, to get all materials/manufacturers approved by the Consultant/ Employer prior to procurement and placement of order.

Wherever brand is not mentioned, Execution agency shall take prior approval of brand complying with the tender specification show ever mentioning the brand considered in the Bid submission shall prevail if specified earlier.

Whenever called for by the Consultant/Employer, all tests of the materials as specified by the relevant IS Codes shall be carried out by the Execution agency in an approved laboratory, and test reports duly authenticated by the laboratory shall be submitted to the Consultant/Employer for his approval. If so desired by the Consultant, tests shall be conducted in the presence of the Consultant or his authorized nominee.

Quality and acceptability of materials not covered under this section shall be governed by the relevant IS Codes. In case IS code is not available for the particular material, other codes e.g. B.S. or DIN or API/ASTM etc. shall be considered. The decision of Consultant/Employer in this regard shall be final and binding on the Execution agency.

Whenever asked for, the Execution agency shall submit representative samples of materials to the Consultant/Employer for his inspection and approval. Approval of any samples does not necessarily exempt the Execution agency from submitting necessary test reports for the approved material, as per the specification/relevant IS Codes.

The Execution agency shall submit manufacturer's test reports on quality and suitability of any material procured from them and their recommendation on storage, application, workmanship etc. for the intended use. Submission of manufacturer's test reports does not restrict the Consultant/Employer from asking fresh test results from an approved laboratory of the actual material supplied from an approved manufacturer/source at any stage of execution of work.

All costs relating to or arising out of the tests and submission of test reports and or samples to the Consultant/Employer for his approval till the date of issuance of Performance Certificate shall be borne by the Execution agency.

Materials for approval shall be separately stored and marked, as directed by the Consultant/Employer and shall not be used in the Works till these are approved.

All rejected materials shall be immediately removed from the site by the Execution agency at his own cost.

2. General Standards

The new facilities shall be completed to high standards of construction and specification. The facilities shall be technically and functionally suitable to meet the Employer's objectives:

The Architectural finishes shall be of such quality that will ensure better hygienic conditions.

The design of the building shall ensure control of noise due to walking, movement of trolleys and banging of doors etc.

The architectural design should take into account the requirements of physically challenged persons.

All the material procured or to be used should be to the satisfaction of the engineer before being used for the works intended to.

All sanitary/water supply fixtures and fittings shall be of approved make confirming to IS specifications and with ISI Marks.

The design should incorporate fire detection i.e., fire extinguishers in accordance with the rules and regulations of the local fire authority.

Lighting should confirm to NBC for Lighting. All electrical system, fixtures, fittings etc. should confirm to CPWD specifications, latest IS code etc.

Provision should be made for internal and external signages, display boards in the required area.

Finishing in the room of all buildings should be complete in all respects including, communication networking for telephone connection, Cable TV up to the terminal point of service provider, power points etc.

All the areas should have power backup systems for emergency services.

Mechanical services shall be designed and installed with provisions to contain noise and the transmission of vibration generated by moving plant and equipment schedules to achieve acceptable noise and vibration with respect to human beings specified by ISO standards.

3. Statutory, Industry and Local Standards

The following standards shall apply unless otherwise stated:

- The standards set out in National Building Code of India 2016 & CPWD latest version.
- The relevant Development Control Rules/Planning Act/Development Act/Municipal Act/any other applicable statutes and local by-laws.
- The National Electrical Code, 1985.
- The Indian Electricity Act 2003. Requirements of the local Water Supply Company, Electricity Supply Company/ Department.
- Any other statutory requirement for execution of work and to occupy the buildings and run the services in all respects.

- The Execution agency is required to submit the relevant drawings and any other statutory documentary requirements of local bodies in copies as per requirement to obtain the approval etc. at their own cost.

4. Unacceptable Materials and Processes

The materials and processes given below must not be used in the New Facilities or in connection with the New Facilities.

- Sea dredged aggregates or aggregates for use in reinforced concrete
- Asbestos cement products; or asbestos in any other form including vermiculite containing asbestos fibrous dust
- Lead or any products containing lead for use in connection with drinking water
- Materials which are generally composed of mineral fibers either man made or naturally occurring which have a diameter of 3 microns or less and a length of 200 microns or less or which contain any fibers not scaled or otherwise stabilized to ensure that fiber migration is prevented
- Urea formaldehyde
- Plastics for water storage and delivery that release toxic materials
- Materials containing vinyl chloride unless risk form carcinogen is shown to be negligible.
- Vermiculite containing asbestos fibrous dust
- Cellulose fiber
- Polyurethane foam or poly iso cyanurate foam unless the risk is shown to be negligible
- Plywood with glues, resins and surface treatments that produce irritant volatiles
- Decorative finishes containing lead or asbestos
- Materials containing chlorofluorocarbons (CFCs)
- Paints and wood preservatives containing pentachlorophenois (PCPs) tributyl tin oxide (TBTO) or Lindane
- Any treatment of materials either before or after installation which give rise to toxic or hazardous emissions or particles
- Any other substances generally known at the time of use to be deleterious to health and safety or to the durability of the works in the particular circumstances they are used.

General Specification

The work shall be carried out strictly as per CPWD specifications unless or otherwise specified. The broad items and specifications to be followed are given in BoQ attached as per tender document showing references of DSR items. The specifications and items which are not mentioned shall be deemed to be included in the cost and shall be executed as per direction of Engineer-in-Charge with reference to relevant DSR items/CPWD Specifications/CWC textile manual (latest version with up-to-date amendments)/MORTH Specification No. 700 & 2504 shall be as follows and shall be as per the direction of Engineer-in-Charge.

- **Cement**

The cement used shall be Portland-Pozzolana conforming to IS: 1489.

- **Fine Aggregate (Sand)**

Fine aggregate shall consist of suitable clean, hard, strong and durable natural or manufactured sand. It shall not contain dust, lumps, soft or flaky materials, mica or other deleterious materials in such quantities as to reduce the strength and durability of the concrete, or to attack any embedded

steel, neoprene, rubber, plastic, etc. Motorized sand washing machines shall be used to remove impurities from the fine aggregate. Fine aggregate having positive alkali-silica reaction shall not be used. All fine aggregates shall conform to IS: 383, (Parts 1 to VIII). The fineness modulus of fine aggregate shall neither be less than 2.0 nor greater than 3.5. Aggregate grading shall be reasonably consistent and shall not exceed the maximum size which can be conveniently handled with available pumping equipment, nor exceed the maximum size which allows the proper and efficient filling of the fabric formed concrete lining.

• **REQUIREMENT FOR FINE AGGREGATE**

IS Sieve Size	Percent by Weight Passing the Sieve		
	Zone – I	Zone - II	Zone – III
10 mm	100	100	100
4.75 mm	90-100	90-100	90-100
2.36 mm	60-95	75-100	85-100
1.18 mm	30-70	55-90	75-100
600 micron	15-34	35-59	60-79
300 micron	5-20	5-30	12-40
50 micron	0-10	0-10	0-10

• **Plasticizing and Air Entraining Admixtures:**

Any air entraining agent or any other admixture may be used, as approved, by the Engineer-in-charge to increase workability, to make concrete impervious and more durable. Air entraining admixture shall conform to ASTM, Indian Standards (IS) or International Organization of Standards (ISO).

• **Measurement and payment**

- i. The surface area shall be measured in ‘sqm’. The bidder shall include cost of allowances for cutting, wastage, anchorage, shrinkage, overlaps and apron, etc. and no additional measurement & payment shall be considered for these factors.
- ii. The measurement and payment for the fine aggregate concrete shall be made based on the volume of concrete inside the mattress including the cost of cement, fine aggregate, machinery required, tools and plants.

TECHNICAL SPECIFICATIONS - PUBLIC HEALTH ENGINEERING WORKS**1. Introduction:**

- 1.1 The intent of this technical specification covers all construction related to Public health Engineering works (Plumbing & Sanitary) as covered in the scope of contract as per drawings supplied by Owner.
- 1.2 All works shall be carried out as per design/drawings standardized by the Consultant/ Owner and these specification provided by the Consultant/ Owner. All standard drawings are enclosed with the tender documents. In case any item is not covered under specification then the same shall be carried out as per CPWD specification and applicable Standards and Codes. Any item for which specification is not provided herein and is not covered under CPWD specification shall be executed as per manufacturer guidelines. All materials shall be of best quality conforming to relevant Indian Standards and Codes. In case of any conflict between Standards/ Code and Technical Specification, the provisions of Technical Specification shall prevail.
- 1.3 The Contractor shall furnish all labour, tools, equipment, materials, temporary works, constructional plant and machinery, fuel supply, transportation and all other incidental items not shown or specified but as may be required for complete performance of the Works in accordance with drawings, specifications and direction of Owner.
- 1.4 All materials including cement, reinforcement steel and structural steel etc. shall be arranged by the Contractor. All testing required shall be arranged by the Contractor at his own cost. The contractor shall execute the work as per the Field Quality Plan (FQP) attached with this document.
- 1.5 The bidder shall fully apprise himself of the prevailing conditions at the proposed site. Climatic conditions including monsoon patterns, local conditions and site specific parameters and shall include for all such conditions and contingent measures in the bid, including those which may not have been specifically brought out in the specifications.

2. SCHEDULE ITEMS

- 2.1 The Items of works considered based on Delhi Schedule of Rates are termed as Schedule Items.
- 2.2 The work shall be executed in accordance with the specification stipulated in the Bill of Quantity and other bidding documents read along with CPWD (Central Public Works Department) specifications-2009 for civil works and IS codes with up to date corrections. For non-schedule items specification as given along with tender document and similar items of CPWD shall be applicable.
- 2.3 The work shall be executed in accordance with the specification stipulated in the Bill of Quantity and other bidding documents read along with CPWD (Central Public Works Department) specifications-2016 for civil works and IS codes with up to date corrections.
- 2.4 The list of references for civil works are CPWD specifications, relevant IS codes and best practices.

3. NON SCHEDULE ITEMS

The items considered based on market rates of materials & works are termed as Non Schedule Items. For non-schedule items, specification as given in BOQ, Similar items of CPWD and this specification shall be applicable.

TECHNICAL SPECIFICATIONS TECHNICAL SPECIFICATIONS FOR FIRE
HYDRANT SYSTEM

1. Automatic Fire Hydrant System consisting of Diesel Engine (Main pump), Electrical Pump and Jockey Pumps, Sprinkler Pump, G.I. Piping with fittings, M.S Valves, Yard Hydrant Hose Cabinets and Hose Reels, Sprinklers.
2. First Aid Fire Extinguishers System consisting of Carbon dioxide, Dry Chemical Powder Extinguisher and Fire Buckets.
3. **Regulation and Standards:**
 - The installation shall conform in all respects to the following broad list of standard in General and in particular the materials used shall bear prevailing ISI marking:-
 - IS:901-1975: Specification for coupling, double male female, instantaneous pattern for fire Lighting.
 - IS: 902-1974: Specifications for suction hose coupling for fighting purposes.
 - MSS SP 67: Butterfly Valves.
 - API 609: Butterfly valves, lug type and wafer type.
 - IS:1536-1976: Centrifugal cast (spun) cast iron pressure pipe for water, gas and sewage.
 - IS:1239: Mild steel tube, tubular and other wrought steel fittings.
 - IS 1538-78: Cast Iron fittings for pressure pipes for water, gas and sewage.
 - IS: 8423-1977: Controls per collating hose for fire fighting
 - IS:5290-1983:
 - ADI:610: Centrifugal pump for general refinery service
 - IS:1648-1966: Code of practice for fire of Building (General), Lighting equipment, its maintenance.
 - IS:3844-1966: Code of practice for installation for internal fire hydrants in multistory buildings.
 - IS:2871-1983: Branch pipe, universal for firefighting proposes.
 - IS:884-1969: First Aid hose reel for firefighting.
 - IS:5132-1968: Hose reel tubing for fire protection system.
 - BS:5155: Cast iron and carbon steel butterfly valves for general purpose.
 - IS:2190-1979: Code of practice for selection, installation and maintenance of portable fire extinguishers.
 - IS:8090-1992: Specification for coupling branch pipe, nozzle used in hose reel tubing for firefighting.
 - IS:3582-1984: Specification for basket strainer for firefighting purpose.
 - IS:9972-1981: Specification for automatic sprinkler heads.
 - IS:908-1975: Specification for fire hydrant, stand post type.
 - IS:884-1985: Specification for first aid hose reel for firefighting.
 - Latest edition of Fire Protection Manual and Sprinkler Hand Book of the Tariff Advisory Committee.

4. Drawings:-

The drawings enclosed herewith are for the general guidance to the Tenderers. The Contractor shall upon the award of the work, furnish detailed shop drawings necessary to carryout the work at site within 15 day. These shall be submitted for approval to the Architects/Employer. The work shall be commenced only after the approval of drawing by the Architects/Employer and obtaining the approval from Local Fire Authority.

4.1 Drawing/Information Required From Successful Tenderer within 15 Days after Award of Work:-

- Pump GA and Cross-sectional drawings.
- Performance curve for the pump.
- Necessary civil scope drawing for the system.
- Bar chart showing engineering, manufacturing and dispatch of equipment and erection services.

- Drawing, literature and technical particulars of all bought out items.
- Control logic diagram for the pump to start.
- Schedule for valves and piping material.

5. Inspection and Approval:-

The contractor shall arrange all necessary inspection by the Local Fire Authority. He shall also arrange for all the tests, obtain and deliver to the Employer any approval required as per the local by-laws and Local Fire Authority. It is the sole responsibility of the contractor to prepare and submit the drawings to Local Fire Authority and do all liaisons works with Local Fire Authority in getting the complete installation approved by them.

6. Painting:-

All piping equipment, furnished under this specification shall be properly painted with two coats of synthetic enamel paint after installation and shall meet the requirements as outlined in Fire Protection Manual. Paint used for this work will be lead free quality. The cost of painting deems to be inclusive in the respective items.

7. Guarantee:-

The contractor shall guarantee that the material and workmanship of the entire system are of first class quality and shall correspond to standard Engineering Practice. All the equipment/apparatus shall be guaranteed to yield the specified rating and design capacities speeds. Any defective equipment/material/workmanship found short of the specified quality shall be rejected. Contractor shall make good the rejected items at his own cost. Guarantee certificate of equipment from suppliers/manufacturers shall be handed over to the Employer.

8. Defects and Liability:-

All the equipment/material and the system shall be guaranteed against defective material and workmanship for a period of 12 months from the date of commissioning and handing over the Employer along with all relevant documentation. The contractor shall repair/rectify or replaces all the defective materials, components free of cost. In addition, normal maintenance shall be carried out during Defect Liability period of 12 months.

9. Instruction Manual/Completion Drawings/Training:-

The contractor shall furnish detailed instruction and operation manual in quadruplicate. The contractor shall also furnish detailed completion drawings on tracing sheet drawn to an approved scale. The drawings shall be inclusive of control schematic, if any. The contractor shall train the Employer's personnel in the operation and maintenance of the system for one month.

10. Testing:-

The contractor shall arrange to test the entire system as per the procedure enumerated under Particular specification after the erection is completed. The test shall be carried out to the Satisfaction of Architects/Employer. The results of the tests shall be submitted to the Employer. If the results of the tests are not found to be satisfactory by the Architects/Engineer in-charge, necessary rectification

shall be done until the test result are found to be satisfactory. The installation shall be deemed to be completed only after the successful completion of the test.

11. Technical Data:-

The Tenderers shall furnish data of their equipment as per the proforma under 'Technical Data'. The tenders without technical data are liable to be rejected.

Data:-

- a Type : wet riser system.
- b No. of Fire Pumps : 1 Jockey pump, 1 Electrical Pump, 1 Diesel Pump & 1 Sprinkler Pump.
- c Static Water Storage : 2,00,000 Ltrs Storage Sump.

11.1 Piping:-

Above ground piping and underground piping shall be GI tubes of heavy grade unless and until specified conforming to IS-1239 Part-1. GI pipes shall be provided with welded joints only unless flanges are warranted. All fittings shall be medium grade wrought or mild steel conforming to A 234 Gr. WPB Sch. 40 (IS-1239 Part II). The flanges shall be drilled as per relevant Indian Standards. Flanges shall be faced and shall have jointing of rubber insertion of Neoprene Gasket. In case of Tyton pipes, using rubber gaskets as per manufacturer specification shall make the joint. The joints shall be supported of withstanding a pressure of 10.5 BAR. All the above ground piping shall be supported by angle iron brackets on walls or suspended by hangers from ceiling or concrete pedestals at some places. Piping over ground shall be painted with two coats of approved enamel over a coat of primer after the installation and testing.

11.2 Anticorrosive Treatment for Underground Piping:-

G.I. pipe laid outdoor in trenches/buried in earth shall be wrapped with pipe coat membrane consisting of seven layers of polyethylene polymerized bitumen and polyester mat laid over a suitable primer of fiber and solvent based rubber modified bituminous primer of density 0.9 Gms/cum applied at the rate of approx. 200-250 gam/Smt. Material to be laid strictly as per manufacturer's specification and laid under technical assistance of manufacturer's representative.

Pipes passing through masonry walls, foundation, beams shall be taken through embedded pipe sleeve of same material. The pipes sleeve size to be at least 1^{1/2} times the diameter of the crossing pipeline. The pipeline running below floor shall be given anticorrosive treatment same as for underground piping.

11.3 Butterfly Valves:-

Butterfly Valves shall conform the following specification:

- Body: High duty cast iron to IS-210 Gr. FG220 and BS 1452 Gr. 220.
- Seating : Moulded in-situ resilient lining of black nitrite rubber.
- Disk: Nylon coated S.G. Iron to IS 1865/SG 400/12 and BS 2729 Gr. 420/12.

Shaft: The shafts are made of stainless steel AISI 431.

Only flanged End valves to be used with flanges drilled to BS 10 Table F. Valves shall be capable of being locked in open position. Hand Wheel shall be with vertical gear unit for smooth opening and Closing of the valve. Key rods with M.S. coated extended Spindles to be provided whenever the valves are not approachable from the ground surface.

11.4 Non-return Valves:-

Non-return valve shall be of cast iron with gum metal seat, non-return valves shall be of flanged type. Spring-loaded valves shall not be used. The valves shall be suitable for a test pressure of 21 Kgs/Cm².

11.5 Hydrant Valves (Landing Valves):-

Landing valves shall be gunmetal 63-mm dia oblique female instantaneous pattern with caps and chains. Landing valves shall conform to IS-5290 in all respects. Landing valves shall be of gum metal and fitted with instantaneous coupling conforming to IS-901. The coupling shall be fitted with an internal plug secured by a chain. Landing valves shall be installed on hydrant risers at a height of 1.0 to 1.2 Mtrs from the floor level. The landing valves shall be connected to the wet riser standpipes by means of a suitable tee, the cost of which is deemed to be included in the unit rate for piping.

11.6 Hose Pipes :-

All hose shall be of 63 mm diameter made of RRL /CP HOSE as per IS standards.

11.7 Branch Piping and Nozzle :-

Branch pipes shall be of gunmetal to fit into the instantaneous coupling. Nozzle shall be of spray or fog type of diameter of not less than 16 mm and not more than 25 mm. Branch pipe and nozzle shall be of instantaneous pattern.

11.8 Sprinklers :-

The automatic sprinklers shall be installed in the basement and parking. The sprinklers shall be quartz bulb standard response type only and operating at 68 deg. C.

The sprinklers shall be connected through a 25 mm GI pipe of medium class and feeder pipe shall be of 150 mm dia connected to wet riser /down comer.

The contractor shall give required tools for removing and fixing of different types of sprinklers free of cost as directed by Engineer-in-charge.

11.9 Air Valve

The contractor shall provide 25 mm dia screwed inlet cast iron single acting air valves on all high points in the system.

Drain Valve

The contractor shall provide 50mm dia GI pipe to I.S:1239 heavy class with 50mm gunmetal full way valve for draining any water in the system in low pockets as directed by Engineer-In-Charge.

11.10 Hose Cabinet :-

Hose cabinet shall be glass (4 mm thick) fronted with double hinged door and lock. The cabinet shall be made of 16 SWG M.S sheet and spray painted to scarlet red colour with word “**fire**”. The hose cabinet shall be of suitable size to accommodate the following: -

- a. Landing valves (Single Headed)
- b. 63 mm hose pipe (2 lengths of 15 Mtrs each)
- c. Branch pipe and nozzles (one set)
- d. Two keys of break glass recess for keys.

11.11 Fire Pump:

a. Pumping Sets:-

Pumping sets shall be single or multistage horizontal end suction centrifugal pumps with cast iron body and bronze dynamically balanced. Impeller connecting shaft shall be stainless steel.

- b. Pumps shall be connected to the drive by means of a flexible coupling.
- c. Pumps shall be provided with approved type of mechanical seal’ pressure gauge with isolation cock on the delivery side.
- d. The pumps shall be of type approved by local fire authority & IS specifications.
- e. Pumps selected should work under 150% rated flow delivered against 65% of the rated head so as to meet local statutory requirements/Clients requirements.

11.12 Pump Driven By Diesel Engine:

- a. Diesel Engine shall be 4 (Four)-cylinder type with individual head assemblies. The engine shall be water-cooled and shall include radiator, water pump and connecting piping, strainer, isolating and pressure reducing valves, by-pass line complete in all respects.
- b. Engine shall be direct injection type with low noise and exhaust omission levels.
- c. The speed of the engine shall match the pump speed for direct drive.
- d. The engine shall be self-starting type and shall be provided with 12 Volts heavy duty batteries, dynamo, starter, cut-out, starter, cutout battery leads complete in all respects. Two additional spare batteries shall be provided.
- e. The system shall be provided with an automatic fully connected batterer charger of type and capacity required for the system.
- f. System should be designed such a way that both batteries are connected and are individually able to provide automatic pump starting. The battery circuits should be arranged to alternately attempt starting on one circuit first, then the other one battery could be charged by an alternator on the engine with the other one charged by an independent means.
- g. The engine shall be provided with an oil bath air cleaner.
- h. Engine shall be suitable for running on high-speed diesel oil.

- i. The system shall be provided with a control panel with push button starting arrangement and wired to operate the engine on a differential pressure gauge.
 - j. The entire system shall be mounted on a common structural base plate with anti-vibration mounting and flexible connections on the suction and delivery piping.
 - k. Providing one fully mounted and supported day oil tank fabricated from 5-mm thick MS sheet of capacity (size 1 Mtr x 1 Mtr x 0.7 Mtrs) 500 Ltrs with inlet, outlet with valves, gauge glass, manhole cover. The cost of MS frame work for staging to be included.
 - l. Provide one exhaust pipe of MS 3 mm thick with suitable muffler to discharge the engine gasses to outside open air as per site conditions duly painted. Exhaust pipes to be insulated and GI sheet clad from engine outlet up to muffler and located outside the building.
 - m. Provide all accessories fittings and fixtures necessary and required for a complete operating engine set.
 - n. Pressure switches/sensing devices to be mounted on its own independent discharge header for all the four pumps to achieve automatic operation.
- Air vessel Tank made out of 4 mm MS sheet 300 mm dia x 1000 mm long with dished ends in 5 m thick sheet with provision necessary for inlet, outlet, duly painted inside with two coats of anti-corrosive paint of approved synthetic enamel paint.

12 Pump Driven by Electric Motor

12.1 Fire pump shall be electrically driven centrifugal pump of capacity 2850 LPM at 88 MWC. The pump shall be automatic in operation and driven by a totally enclosed fan cooled induction electric motor of 60- 75 HP at 2900 RPM. The construction details of the pumps shall be as follows: -

- a. Pump : Horizontal type end suction
- b. Casing : Cast Iron
- c. Impeller : Bronze.
- d. Shaft : Stainless steel.
- e. Bearings : Heavy-duty ball bearings.
- f. Flanges : Faced and drilled as per BSS-10 tables or IS.
- g. Drive : Direct drive with flexible coupling.
- h. Gland : Horizontal split for each insertor and removal.
- i. Motor : Total enclosed fan cooled inducting motor suitable for operation of 430 Volts, 3 Phase, 50 Hz, and a/c. supply. Motors shall confirm to IS: 325. Motors shall be wound for class-B insulation.
- j. Starting : Automatic starting device with arrangement contactor, pressure switch, etc. and suitable hooter.
- k. Installation : Pump and motor set shall be mounted on a common base plate and

installed on a suitable concrete foundation and curing the same. Suitable anti-vibration springs shall also be installed to minimize the vibration. The pump set shall, however be factory aligned. The bedplate Levels shall be properly fixed at site before the Foundation bolts are grouted.

- i. Pump Accessories** : Pump set shall be provided with the following accessories: -
- a.** Coupling Guard.
 - b.** Air vent for pump casing.
 - c.** Suction and delivery pressure gauges.
 - d.** Base plate, foundation bolts, nuts, washers.

Jockey Pump

Pump shall be electrically driven centrifugal pump of capacity **180 LPM** at 88 MTRS The pump shall be automatic in operation and driven by dip proof squirrel cage electric motor of 15 HP at 2900 rpm.

13 Diesel Engine.

GENERAL

The diesel engine shall be of multi-cylinder type four-stroke cycle with mechanical (airless) injection, cold starting type. The engine shall be manufactured as per IS 10000 and shall be ease of maintenance, repair, cleaning and inspection. This will also provide interchangeability of parts. All parts susceptible to temperature changes shall have tolerance for expansion and contraction without resulting in leakage, misalignment of parts or injury to parts.

STARTING

The engine shall be capable of both automatic and manual start. Generally the engine shall start automatically but in case of the auto-start system failure the engine shall be capable of manual start. Engine shall be able to start without any preliminary heating of combustion chamber; cranking mechanism shall also be provided. All controls/ mechanism, which has to be operated in the starting process, shall be within easy reach of the operator. A DC motor charged by battery shall initiate automatic start of diesel engine. The battery shall hold adequate retainable charge to provide the starting of the diesel engine. Starting power will be supplied from two sets of storage batteries. One set of battery is for automatic starting of the engine and the other provided for manual starting. A selector switch will be provided at automatic starting control panel to select any of the two sets of battery for manual/ auto starting of the engine. The battery capacity shall be adequate for ten consecutive starts without recharging with a cold engine under full compression. The battery banks shall be used for no other purpose other than starting of the engine and shall be fully charged at all

times with provision for trickle and boost charges. After start of the engine the charger shall be disconnected, the battery being fed from the engine dynamo. The two-battery charger of air-cooled type shall be able to charge on battery bank at a time. The D/E starting panel along with the battery chargers should be of reputed approved makes.

GOVERNING SYSTEM

The engine shall have a speed control device which will control the speed under all conditions of load., the governor shall be suitable for operation without external power supply. The Governor shall offer following features: An adjustable governor to regulate engine speed within a range of 10% between shut-off and maximum load conditions of the pumps. The governor shall be set to maintain rated pump speed at maximum pump load.

FUEL SYSTEM

The diesel engine is to run on high-speed diesel, the tank provided being enough to hold the volume required for 6 hours (minimum) continuous operation. Fuel tank shall be double wall type, so that overflow of the fuel shall be collected in the secondary tank. Fuel supply and return piping shall be metal with necessary valves. Fuel tank shall be mounted on the fabricated consisting with air vent, overflow, drain, filling and manhole etc.

COOLING WATER SYSTEM

Direct cooling system shall be employed for the diesel engine. Water shall be tapped from the fire pump discharge. This water shall be led through duplex strainer, pressure breakdown orifice and then after passing through the engine, the outlet water shall be taken directly to the sump through an elevated funnel. Re-circulating thermo siphon system of cooling using a fan cooled radiator or indirect cooling system using heat exchanger shall not be accepted.

ACCESSORIES

The engine shall be mounted on a base plate of fabricated steel construction. Adequate access shall be provided for the big end and main bearings, camshaft and governor drives, water jackets etc., The engine shall have a base plate made from MS sections. There shall be reasonable space at the big end, camshaft, water jackets, governor drives and main bearings. The engine shall be provided with intake and discharge ductwork, inlet filter and silencer, outlet muffler, expansion joints, dampers etc., as necessary for efficient operation. Intake air should be taken from inside the building in which the engine is located, but the exhaust should be discharged outside the building and exhaust duct shall be adequately sized for minimum pressure drop as per relevant code/standard and shall be housed clearing man height. The flywheel shall have graduated marking around the periphery to facilitate checking of valve and fuel pump timings. Full set of diesel engine spares as per Standard requirement to be provided along with tool kit.

INSTRUMENTATION

The diesel engine shall be provided with adequate instrumentation. The gauges etc., as required are provided for in the Engine Panel. Also Bidder shall supply one set of Spare parts recommended by the manufacturer for maintenance purposes.

Testing

After laying and jointing, the piping shall be pressure tested by hydrostatic method. The piping shall be slowly filled with water in order to expel all the air. The piping shall then be allowed to stand full of water for 24 hours. Any leakage at flanges or elsewhere shall be rectified. The pressure shall then be applied by means of a test pump (either hand operated). The test pressure shall not be less than 1.5 times the working pressure of the system. However the test pressure shall not exceed 10.5 kgs/cm² in any case.

Pressure gauges used for the test shall be accurate and shall preferably have been recalibrated before the test. The open ends of the piping shall be plugged during the test. Capacity of pumps shall be checked with respect to the contractors piping and equipment layout. Tests shall be conducted to determine the delivery head, flow end BHP of pumps after installation. All the test results shall correspond to the performance curves. All the leaks and defects in joints revealed during the testing shall be rectified to the satisfaction of the Employer/TAC Inspector.

The system shall also be tested for its desired performance and function by opening hydrant valves on each floor separately and four landing valves simultaneously. The flow of water at the top most hydrants shall be checked when three landing valves below are open. The cutting in and cutting out pressure setting of starting device shall also be checked for its correct operation.

The test results shall be recorded and countersigned by Employer's representatives and submitted in triplicate for approval by the Employer.

Fire Brigade Inlet Connection

Fire Brigade Inlet Connection to the 150mm feeder line shall be comprised of four instantaneous pattern 63-mm dia. Make inlets with caps and chains complete with non-return valves housed in a 16 Gauge MS cabinet with 4-mm thick glass fronted door. The cabinet shall be 1000 x 300 mm x 400-mm size for recess mounting.

Base Plate

Pumps and motors shall be mounted on a common structural base plate with anti-vibration mounting.

Yard Hydrants

Yard hydrant shall comprise of 80-mm dia M.S. flanged standpipe, 63-mm dia gunmetal instantaneous landing valve. The buried protection shall be anticorrosive treatment as per specification.

14 AUTOMATIC SRINKLER SYSTEM

Sprinkler main, branch and internal piping complete with valves, alarms and supporting arrangements. Sprinkler heads with spare sprinklers. Connections to risers etc., all material shall be of the best quality conforming to specifications and subject to the approval of the Engineer-in-Charge. Pipes and fittings shall be fixed truly vertical/horizontal or on slopes required in a neat manner. Pipes shall be fixed in such a manner so as to provide easy accessibility for repair and maintenance and shall not cause obstruction in shafts, passages etc., Pipes shall be securely fixed to walls and ceilings by suitable clamps at intervals specified. Only approved types of anchor fasteners shall be used for RCC ceilings and walls. Valves and other equipment shall be so located that they are easily accessible for operation, repairs and maintenance.

SPRINKLER HEADS

The sprinkler heads shall be UL listed fixed temperature type with a quartzoid bulb containing liquid having high vapor pressure held in position by a forged GM yoke and deflector. The rated temperature of quartzoid bulb shall be 68 deg. C for complete building. The spacing shall however conform to the detailed drawing, in Co-ordination with electrical and other allied services at the ceiling level. Contractor shall supply spare sprinkler heads and spanners neatly installed in a steel box with glass shutter at an appropriate position approved by the Engineer-in-Charge.

A water motor gong and an inspection test connection shall be provided on the down streamside of the system.

Sprinklers for below false ceiling shall be fixed with recessed (two piece) type Rosette plate fabricated by M.S. sheet of 2mm thick with Powder coated finish of approved color.

Sprinklers for car parking areas and ceiling void shall be upright and for below false ceiling shall be recessed type.

PIPES AND FITTINGS

Pipes for the sprinkler system shall refer to the clause No. 2.0,11.0,12.0 and 13.0 of Section – A above.

Installation Control Valve (ICV)

The sprinkler system shall have Installation control valve (Alarm valve) along with assemblies comprising of: -

- a. Upstream gate valve
- b. In and out pressure gauge
- c. Test connection of adequate size with valve and orifice plate with pressure connections.
- d. Water motor gang with necessary piping, isolating valve, strainer, and drain.
- e. Water valve through a retard chamber.

- f. Test connection.
- g. There shall be two pressure gauges, one for the main's side and another for the installation side. Alarm valve shall be straight through type suitable for wet pipe sprinkler systems. Valves shall be of cast iron with gunmetal internals and suitable for vertical or horizontal installation. The valve clapper shall be of cast gunmetal with neoprene.

A test connection of adequate size as shown or shall approved shall be provided with a shut-off gate valve, an orifice plate with pressure connections. The discharge from the test connection outlet shall be led to the nearest sump or drain as shown in drawings.

The Installation Control Valve shall be double-seated clapper type check valve. The body and cover shall be made from Cast Iron to IS: 210: 1993 Grade FG 200. The seat and seat clamp shall be made from bronze to IS: 318: 1981, LTB II grade. The sealing to the seat shall be neoprene gasket. The hinges pin and ball shall be from stainless steel.

It shall be vertically mounted and the direction of water travel shall be indicated on the surface. It shall be rated to 12 Kg/sqcm and tested to 25 Kg/sqcm pressure.

A By-pass check valve shall be fitted to adjust minor and slow variations in water pressure for balancing so as to avoid any false alarm.

The valve shall also be provided with a Test Control Box. The Box shall house a lever to test and operate the ICV. A brass strainer shall also be provided at the point of water supply to the Alarm gong. A Retarding Chamber shall also be provided. The Chamber shall be able to balance the water pressure in case of water line surges.

Each Installation Control Valve shall have two sets of Pressure Gauges with brass ball valve type shut off.

A Water Motor Alarm shall also be provided. This shall be mechanically operated by discharge of water through an impeller. The drive bearing shall be weather resistant. A strainer shall be provided on line before the nozzle. The Gong piece shall be constructed from bronze to IS: 318: 1981, 2 TB II Grade, and base of cast iron. The Motor Housing, Rotor and Housing Cover shall be pressure die cast aluminium.

Foam type fire extinguisher

Portable AFFF Foam Type fire extinguisher 9 Lt Capacity, Stored Pressure Type with Pressure Gauge, hose and brackets etc .The discharge Range shall be minimum of 6 mtrs. The Internal Coating of Can shall be Epoxy Powder coating and External painted with Epoxy Polyester Powder coating .The thickness shall not less than 2mm made of Sheet metal. The Fire Extinguishers shall be ISI Approved as per IS 15683:2006. Vendor shall consider the suitable signages along with the extinguishers.

Water type fire extinguisher

Portable Water type Fire Extinguisher 9 Lt Capacity, Stored Pressure Type, Pressure Gauge and mounting bracket etc. The discharge Range shall be minimum of 6 mtrs. The Internal Coating shall be Epoxy Powder coating and External painted with Epoxy Polyester Powder coating .The thickness shall not less than 2mm made of Sheet metal. The Fire Extinguishers shall be ISI Approved as per IS 15683:2006. Vendor shall consider the suitable signages along with the extinguishers.

Fire Buckets

Providing, fixing, testing and commissioning of Fire buckets round bottom type enamel painted, white inside & Red outside and Letter "FIRE" in black outside and handle with mounting bracket. The buckets shall be filled with sand. Fire bucket stand fabricated by MS angles to install 2 Nos. of buckets.

Excavation of Trenches

Excavation for pipelines shall be in open trenches to line and grade or as required at site including disposal outside of site at approved dumping yard with the prior approval of concerned authorities. Pipelines shall be buried to a minimum depth of 1M (top of the pipe) from the finished ground level.

The contractor shall support all trenches or adjoining structures with adequate timber supports wherever required.

On completion of testing and painting of the pipelines, trenches shall be refilled with excavated fine earth in 20cms. Layers and consolidated by ramming and watering.

Thrust Blocks

Contractor shall provide suitable PCC blocks of suitable dimensions at Change – in – direction and at “T” junctions (in case of filled earth or loose soil supports shall be provided at regular intervals of 6 meters) to support the pipes. Minimum Size of Blocks shall be 600mmx600mmx450mm. If any specific requirement as per site conditions, contractor shall bring to owner /consultant notice

Valve Chambers

Contractor shall provide suitable brick masonry chambers in cement mortar 1:5 (1 cement: 5 Coarse sand) on cement concrete foundations 150mm thick 1:5:10 mix (1 cement: 5 fine sand: 10 graded stone aggregate 20mm nominal size) 15mm thick cement plaster inside and outside finished with a floating coat of neat cement inside with cast iron surface box (OR top cover fabricated by M.S. chequered plate of 6 mm thick with frame / stiffeners etc) approved by local fire brigade including excavation, back filling and additional Iron rungs for entering in to valve chamber etc, complete. Valve chamber shall be raised at least 50mm above the finished ground level around it and cover shall be fixed in such a way when it opens / closes should not damage the wall. Valve chambers shall be 1200mm x 1200mm x 1500mm depth.

TECHNICAL SPECIFICATIONS - LIFT / ELEVATORS WORKS**1.0 General :-**

This specification covers design, manufacture, testing as may be necessary before dispatch, delivery at Site, all preparatory work, assembly and installation, commissioning putting into operation of lifts.

2.0 Rates:-

2.1 The rates quoted by the tenderer, shall be firm and inclusive of all taxes (including works contract taxes) Duties, Octroi and Levies or GST and all charges for packing forwarding, insurance, freight and delivery, installation, testing, commissioning etc. at site i.e. temporary constructional storage, risks, overhead charges general liabilities / obligations and clearance from local authorities.

2.2 The contractor has to carry out routine and preventive maintenance for 12 months from the date of handing over. Nothing extra shall be paid.

3.0 Completeness Of Tender:-

3.1 All sundry equipment, fittings, unit assemblies, accessories, hardware items, foundation bolts, termination lugs for electrical connections, and all other items which are useful and necessary for efficient assembly and installation of equipment and components of the work shall be deemed to have been included in the tender irrespectively of the fact whether such items are specifically mentioned in the tender documents or not.

3.2 For item / equipment requiring initial inspection at manufacture's works the contractor will intimate the date of testing of equipment at the manufacture's works before dispatch. The Client also reserves the right to inspect the fabrication job at factory and the successful tenderer has to make the arrangement for the same. The successful tenderer shall give sufficient advance notice regarding the dates proposed such tests / inspection to the Client's representative (s) to facilities his presence during testing / fabrication. The Engineer-in-charge at his discretion witness such testing / fabrication. Also equipment may be inspected at the manufacture's premises, before dispatch to the site by the contractor.

4.0 Completion Of Period :-

The completion period as mentioned in the Appendix / indicated in the tender documents is for the entire work of planning, designing, supplying, installation, testing, commissioning and handing over of the entire system to the satisfaction of the Engineer-in-Charge after obtaining the license from the lift inspector of Local / State Government. And certification of competent local authority in respect of compliance of factory act lift provision.

5.0 Data Manual and Drawings to be furnished by the Tenderer:**5.1 With Tender:**

The tenderer shall furnish along with the tender, detailed technical literature, pamphlets and performance data for appraisal and evaluation of the tender.

5.2 After Award of work:

The successful tenderer would be required to submit the following drawings for approval before commencement of installation.

5.3 All General Arrangement Drawings:

Details of foundations for the equipment, load data, location etc. of various aspects of equipment as may be needed generally by other agencies for purpose of their execution. The data will include breaking load on guides; reaction of buffers on lift pits required, support points in machine room, lift well etc.

5.4 The General Arrangement Drawing in triplicate will be forwarded by Contractor. The purpose of this drawing is to clearly indicate to the contractor pertinent dimensional details of the elevator shaft, pit, machine room, car and landing entrances, etc.

5.5 Complete layout dimensions for every unit /group of units with dimensions required for erection purposes.

5.6 Any other drawing / information not specifically mentioned above but deemed to be necessary for the job by the contractor.

5.7 The successful tenderer should furnish well in advance three copies of detailed instruction manuals of manufactures for all items of equipment regarding installation, adjustment, operation and maintenance i.e. preventive maintenance & trouble shooting together with all the required data sheets, spare parts catalogue and workshop procedure for repairs, assembly and adjustment etc. all in triplicate.

6.0 Extent Of Work :-

6.1 The work shall comprise of entire labour including supervision and all materials necessary to complete installation and such tests and adjustments ad commissioning as may be required by the Client. The term complete installation shall not only mean major items of the plants, equipments covered by specifications but all incidental sundry components necessary to complete execution and satisfactory performance of installation with all layout charts whether those have been mentioned in details in the tender document in connection with this contract.

7.0 Inspection And Testing :-

7.1 Copies of all documents of routine and type test certificates of the equipment, carried out of the manufacturers premises shall be furnished to the Engineer-in-Charge and consignee.

7.2 After completion of the work in all respect the contractor shall offer the installation for testing and operation.

7.3 The following tests shall be carried out to the satisfaction of the owner.

- a. Insulation and earth test for all electrical apparatus.
- b. Continuous operation of the lift under full load conditions for one hour at the end of which time the temperature of the motor and operating coils will be tested. This shall be as per I.S specifications.

8.0 Compliance With Regulations And Indian Standards:-

8.1 All works shall be carried out in accordance with relevant regulation, both statutory and those specified by the Indian Standards related to the works covered by these specifications. In particular the equipment and installation will comply with the following:

8.1.1 Factories Act.

8.1.2 (ii) Indian Electricity Rules

- 8.1.3** IS. & BS Standards as applicable
- 8.1.4** Workmen's Compensation Act.
- 8.1.5** Statutory norms prescribed by local bodies.
- 8.2** Nothing in this specification shall be construed to relieve the successful tenderer of his responsibility for the design, manufacture and installation of the equipment with all accessories in accordance with currently applicable statutory regulations and safety codes.
- 9.0 Erection Tools:-**
- 9.1** No tools and tackles either for unloading or for shifting the equipments for erection purposes would be made available by the Client. The successful tenderer shall make his own arrangement for all these facilities.
- 10.0 Verification Of Correctness Of Equipment At Destination:-**
- The contractor shall have to produce all the relevant records to certify that the genuine equipment from the manufactures has been supplied and erected.
- 11.0 Painting:-**
- This shall include cost of painting of entire exposed iron work complete in the installation. All equipment work shall be painted at he works before dispatch to the site.
- 12.0 Training:-**
- The scope of works includes on job technical training of two persons at site. Nothing extra shall be payable on this account
- 13.0 Maintenance:-**
- 13.1 Sufficient:-**
- Trained and experienced staff shall be made available to meet any exigency of work during the guarantee period of one year from the handing over at the installation.
- 13.2** The maintenance, routine as well as preventive for one year from the date of taking over the installation as per manufactures recommendation shall be carried out and record of the same shall have to be maintained.

GENERAL TECHNICAL SPECIFICATIONS FOR LIFT / ELEVATORS WORKS

These general specifications cover the details of equipment to be designed, supplied, inspection as may be necessary before dispatch, delivery at site, installation, testing, commissioning and handing over in working condition of electrical lifts.

Related Documents:

These technical specifications shall be read in conjunction with the General Conditions of contract with all correction slips, as well as schedules and drawings. In the event of any discrepancy between these specifications and inter-connected contract documents, the technical requirements as per the tender specifications shall be followed and deem to be having over-riding value.

Conformity With Statutory Acts, Rules, Regulation, Standards And Safety Codes :-

The installation shall be carried out in conformity with the local lifts Act and Rules. The installation shall also conform to requirements of local Municipal Bylaws.

Indian Electricity Act and Rules

All Electrical works in connection with installation of electric lifts shall be carried out in accordance with the provisions of Indian Electricity Act 2003 and the Indian Electricity Rules 1956 amended up to date.

Safety Codes and Labour Regulations

The contractor shall at his own expenses arrange for the safety provisions as per the statutory regulations. IS recommendations, regulations under Factory Act etc., where applicable and instructions issued from time to time in respect of all labour employed by him directly or indirectly for the installation of the lift.

The contractor shall provide necessary barriers, warning signs and other safety measures etc., wherever necessary so as to avoid accident. In addition all safety procedures as outlined in the tender shall be complied with.

In case of default the client shall be at liberty to make arrangements and provide facilities as aforesaid and recover the cost from the contractor.

Fire Regulations

The Installation shall be carried out in conformity with the local fire regulations and rules there under wherever they are in force.

Works To Be Done By The Contractor:

In addition to the manufacture, supply, installation, testing and commissioning of the lift including all auxiliary equipment, following works shall be deemed to be included within the scope of the work to be done by the contractor.

Supply of necessary R.S joists or angle iron supports brackets etc., for installation of the lift either in the machine room or at other places as may be necessary including their installation in position.

Responsibility to ensure safety of lift materials against pilferage and damage till the installation is handed over to the Employer

All Scaffolding as may be necessary in the lift well during erection work and subsequently removed. Temporary barricades with caution boards at each landing to prevent accident during execution of work.

Supply and installation of landing fascia plates made of steel, car apron plates, sill support angles with necessary clamps; foundation bolts supports etc., as are necessary in connection with the installation of the lift.

Steel ladder to be provided for access to lift pit wherever required under regulations.

All electrical work from panel to lift controller and machine etc. shall be done by lift supplier and same should be included in his bid.

Providing of hoisting beam in the machine room for hoisting of equipment during erection and to facilitate maintenance in future including their fixing etc.

Providing and fixing of necessary sill supporting projection sheet steel fascia plates on all landing as per requirements.

Completeness of Tender:

All fittings, equipment, units, assemblies and accessories, hardware, foundation bolts, terminal lugs for electrical connections, cable glands, junction box and items which are useful and necessary for efficient assembly in operation and installation shall be deemed to have been included in the scope of work. The installation shall be complete in all details whether such details have been mentioned in the specifications or not.

Information to be supplied by Contractor after Award of Work:-

The contractor shall provide the client his program bar chart for submission of preliminary drawing, manufacturing of equipment, installation, testing, commissioning and handing over. This should be correlated with the building completion program. The contractor shall be required to submit in triplicate the following drawings and information for approval of the client through architect/consultant before commencing the work:

- All general arrangement drawings:
- Details of foundations for equipment, load data location etc. of various assembled equipment as may be needed generally by other agencies for purpose of their work. The data will include breaking load on guides, reaction of buffers on lift pits, reaction on support points in machine room, lift well etc.
- Complete layout dimensions for every unit/group of units with dimensions required for erection purposes.
- Motor sizing calculation.
- Brake selection calculation.
- Single line/Schematic diagram of electronic control panel.
- Layout of lift machine room showing electric control panel, elevator equipment etc.
- Cable size calculation along with cable and equipment layout.
- Rope size calculation.
- Earthing layout.
- Inspection manuals for equipment and accessories covered in the scope of supply.
- Technical literature of operation and control.

- Any other drawing/information not specially mentioned above but deemed to be necessary for the job by the contractor.
- List of items to be carried out by the client in accordance with the tender accepted.

ACCEPTABLE MAKES OF MATERIALS

Acceptable makes of material to be used in the work are enclosed. In case of non-availability of these makes, after approval of WAPCOS, The Contractor can use only the alternative makes that have been approved by BIS (Bureau of Indian Standards). Non-BIS marked materials may be permitted by WAPCOS only when BIS marked materials are not manufactured.

LIST OF PREFERRED MAKES		
CIVIL ITEMS		
S NO	DESCRIPTION OF ITEMS	PREFERRED MAKES
STRUCTURAL & CIVIL		
1.	Ordinary Portland Cement/ Portland Pozzolona Cement	ACC/ Ultratech/ J K Cement/ Lafarge/ Ambuja Cement/ L&T
2.	White Cement	Birla White/J K White/ La Farge
3.	Ready Mix Concrete	Ultra tech concrete/ L & T Concrete/ RMC India/ Neptune Readymix/ CVC Readymix/ Supreme Readymix
4.	Reinforcement Steel	TISCO/ SAIL/ RINL
5.	Structural steel, MS Pipes	TISCO/ SAIL/ RINL (For Misc requirement like railings, grills etc procurement can be made from local market if the materials are not available with main products as decided by the Engg in charge)
6.	Chlorpyriphos/ Imidachlor (For Anti-Termite Treatment)	SAHAKAR of M/S KARNATAKA CO-OP. MARKETING FD. LTD., TERMISAC OF M/S. BAYER INDIA LTD, BHAGIRADHA Chemicals LTD, Hyderabad
7.	Reticulate pipe system (Post construction-Anti-termite)	Item secure
8.	Curing Compound	Fosroc/ Sika/ Cico/STP/ Pidilite/ BASF
9.	Plasticizer, Super Plasticizer, Admixtures, Other construction chemicals	M C Bauchemie/ Fosroc/ Pidilite/Sika/ BASF
10.	Waterproofing Compound	Pidilite Industries/Scott no1, ACCOPROOF, Fosroc Chemicals/ SIKKA
11.	Swellable Bar	Pidilite/ Fosroc/ Hayakawa/MYK Schomburg
12.	Pile Head Treatment	RENDEROC RG
13.	Expansion Joint-Modular	C.S/ Hercules/ Z-Tech Vexcolt/ Devin / Sainfield
14.	Polycarbonate Sheet	GE Plastic/ Gallina/ Danapalon
15.	Decking Steel Sheet	Tata Steel/ Lloyds/ JSW Steel Ltd
16.	Shuttering Ply	Archid/Century/Merino/ Kitply
17.	Rebarring Chemical	Hilti/ 3M India/ Birla
18.	Fire Sealant	Hilti/ 3M India/ Fischer
19.	Parallel Threaded Couplers (Compliant to IS:16172:2014)	Dextra/ Halfen Moment/G-Tech
20.	Extruded Polystyrene Board	STP/ Supreme/Owens Corning/Shalimar
21.	AAC block	Aerocon/Builtech/Instablock/JK/Magicrete
22.	AAC Mortar	Ferrouscrete/ Ultratech/ JK
23.	Moisture Resistant Board	Greenlam/ Duro/ Merino
24.	Veneered Particle Board	Merino/ Duro/ Greenlam/ Kitply

25.	Lamiated Particle Board/Laminates	Merino/Greenlam/Century/ Novapan/Greenpanel
26.	Flush Door Shutter	Kutty flush doors,Chennai/KSFIC, Bangalore/Anad wood crafts, Hyderabad/ Anchor flush doors//Greenpanel
27.	uPVC Door and Window	Fenesta/PABROS/Saint Gobain
28.	Toilet Cubicles	Merino/ Greenlam- Maikasa/ Dorma
29.	Plywood/ veneer/ Laminate	Merino/Greenlam/Century/ Duro/Greenpanel
30.	Melamine Polish	Asian Paints Melamine Gold/ Wudfin of Pidilite/ Timbertone of Akzonobel(Dulux)
31.	Polyster Powder Coating Shades	Nerolac/ Berger/ Akzonobel
32.	Silicon based water repellent/ Weather Sealant	G. E Plastics/ Dow Corning/Pidilite
33.	Poly-Sulphide Sealant	Fosroc/ Pidilite/ Sika/ Laticrete
34.	Wall Putty	Birla putty/JK Putty/ Asian putty
35.	Oil Bound Washable Distemper	Asian Paints/ Akzonobel/ Dulux Berger/ICI Nerolac
36.	Acrylic Distemper	Berger/ Asian/ Dulux
37.	Premium plastic emulsion paints	Low VOC Paints - Asian/ Berger/ Jotun
38.	Premium Acrylic Emulsion paints	Dulux/ Nerolac/Asian Paints/Berger
39.	Cement Primer	BP White (Berger)/Decoprime WT (Asian)/Akzonobel (Dulux)/Nerolac
40.	Steel /Wood Primer	Akzonobel (Dulux)/ Nerolac/ Asian Paints/Berger/Jenson &Nicholson
41.	Textured Exterior Paint	Akzonobel (Dulux) /Asian (Apex Ultima)/ Nerolac Kansai (Excel)/Ultra Tech Spectrum Berger
42.	Synthetic Enamel Paint	Akzonobel (Dulux)/ Asian (Apolite)/ Kansai Nerolac (Synthetic Enamel)/ Berger
43.	Water based semi enamel paint	LOW VOC PAINTS- Asian/ Berger/ Jotun
44.	Epoxy Flooring	BASF/ Fosroc/ Flowcrete
45.	Heat Resistant Tiles	Swastik/ Thermax/ Dalal Tiles
46.	Gypsum Plaster	Ferrous Crete/ Elite (90)/ Ultratech
47.	Pre-Cast GRC Jali	Unistone/ Dalal Tile Industries/ KK
48.	Stainless Steel	Salem Steel/Jindal Alloys/ SAIL
49.	Welding Electrodes	Advani/Oerlikon/ Modi
50.	Stainless Steel Hardware	Dorma/ Hafale/Geze/Godrej
51.	Hydraulic door closers	Godrej/ Hayden/ Everite/ Ozone/Hettich
52.	Silicon/ Weather sealant	Dow corning, Other brand If any shall be as per advice of the consultant
53.	Low VOC Paints	Asian Paints, Nerolac, Spectrum
54.	Frosted film	Garware films/3M
55.	Epoxy levelling topping	Epoxy, Arcoy industries,MRF
56.	Adhesives	Pidilite Industries, Fosroc chemicals, SIKA India Ltd
57.	Admixtures	Auramix 500/400 Series - Fosroc/ ROFF/ Pidilite
58.	Clay tile cladding	Clayton/ Faveton
59.	External veneer cladding	Prodema panels
60.	Zinc cladding	VM Zinc Aerofin Louvers
61.	Cement board cladding	Favemanc - Lama Cuadrada
62.	Cladding	PLACA Panel cladding
63.	HPL cladding	Trespa / Fundermax cladding
CEILINGS		
64.	Glasswool Insulation	UP Twiga/Poly Glass/ Ownsorning
65.	Rockwool Insulation	Lloyds/ Roxul Rockwool/ Grodan

66.	False ceiling – Gypsum & Sections	Saint Gobain/ USG Boral/ India Gypsum
67.	False ceiling - Metal	Saint Gobain/ Amstrong/ Hunter Douglas/ USG Boral
68.	Gypsum Board	Saint Gobain/ USG Boral/ India Gypsum
69.	Open cell ceiling	Amstrong/Durlum/ SAS/ Hunter Douglas
70.	Baffle ceiling	Amstrong/ Durlum/ Hunter Douglas/ USG Boral
71.	Acoustical Tile False ceiling	Amstrong/ USG Boral / Hunter Douglas/Anutone/ Dexune
72.	Acrylic Solid Surfaces	Hanex/ L.G-Hymac/ Dupont
FLOORINGS		
73.	Mosaic/Chequered Tiles	Pavit / Somany / Kajaria
74.	Glazed Anti-skid, Designed ceramic tiles	Kajaria/ Somany/ Orientbell/ Hindware
75.	Vitrified tiles	Kajaria/ Somany/ Orientbell/ Hindware
76.	PVC Flooring	Amstrong/Tarquet/LG
77.	Italian marble	Perlato/Rosso verona/ Fire red/ Dark emperasdore/ Approved by architect
78.	Hardwood flooring	Mikaso- Green/ Junckers/ Pergo //Greenpanel
79.	Grass paver	KK Manhole
80.	Paver Block & Kerb Stone	KK Manhole
81.	Tile/Stone Adhesive/Tile Grout	MYK Laticrete/ Fosroc,BASF
82.	Dash/ Anchoring Fasteners	Hilti/ Fisher/ Bosch
83.	Floor Hardener	Ironite/Fosroc/Hardonite
GLAZINGS		
84.	Anodised Aluminum Hardware (Heavy Duty)	Bharat Win Solutions/ A2Z Infra Solutions/ Urban Space or equivalent
85.	Aluminum Structural Members – Windows, Glazing and Partitions	Bharat Win Solutions/ A2Z Infra Solutions/ Urban Space or equivalent
86.	Glazing structural/ suspended/ Spider	Modi guardian glass/ AIS Glass/ Saint gobain
87.	Clear / Float / Frosted Glass / Mirror	Saint Gobain /AIS /Pilkington /MODI Guardian
88.	Mirror Glass	Atul/ Modi Guardian/ Saint Gobain
89.	Glass Spider Fittings	Dorma/ HAFAL/ OZONE/ Enox
90.	Stainless Steel Railing, Accessories etc in Grade SS 304	Dorma/D-line/Jindal/Ozone Geze
91.	Aluminium composite Panels	Aluco Bond/Virgo Aluminum/ Alumaze
92.	Insulated Aluminum panels	Luxalon Qbiss /Hunter Douglas
93.	Ceramic panel Cladding	Hunter Douglas/Neolith/Terreal
94.	Aluminum Louvers	Hunter Douglas/Colt/ Kawneer
95.	Hydraulic door closer	GODREJ/ HAYDEN/ EVERITE/ OZONE/ HETTICH
96.	Aluminium sections	Aluk/ SAPA/Reynears
97.	Floor springs	Hayden/ Everite/ Ozone/ ENOX
98.	Ceramic panel Cladding	Hunter Douglas ,Neolith , Terreal
99.	Aluminum Louvers	Hunter Douglas / Colt/ Kawneer
100.	G. I Steel door frame	Synergy Thrislington, Shakti, Navair
101.	Friction Stay Hinges	Dorma, Dorset, LG Sysmac
102.	EPDM Gasket	Hanu Osaka / Alps Anand
103.	Glass Processor for making DGU/ Toughing	Approved by Glass Manufacturer ONLY.
104.	Polysulphide sealant	Wacker/Dow Corning/ GE
105.	GI Plastermesh	ARPITHA Buiding products, BANGALORE/ National wire products,Pune

106.	Automatic sliding door	DORMA, GANDHI AUTOMATION PVT LTD,MUMBAI
107.	Laminated Glass	AIS/ Saint Gobain/ Guardian glass, Other brand If any Shall be as per advice of the consultant. PVD Layer -Kurray, Torsifol, Eastman, Saflex
108.	Pressed steel door frames	Shop fabricated. Steel from TISCO, SAIL, RINL (Acceptable manufacturers are Deccan Structural Systems Pvt Ltd, Bangalore, Madhu Industries, Bangalore, Royal Fab, Pondicherry or any other capable manufacturer approved by engineer-in-charge.
109.	SS Hand rail	DLine/ Dorma/ Ozone
110.	Structural double glazing	GLAVERBELL/ GUARDIAN / SAINT GOBAIN
111.	Hermitically sealed Toughened performance Glass	GLAVERBELL/ GUARDIAN / SAINT GOBAIN SKN/MODI GUARD
112.	Fire rated Door	Navair/Tata/JSW/Bajaj
HARDWARE		
113.	Nuts / Bolts & Screws	GKW/Hilti/ Atul
114.	Door Closer	Dorma/ Geze/ Enox/ Godrej
115.	Die Cast Patch Fittings	Dorma/ Geze/ Enox
116.	Floor Springs	Dorma/ Geze/ Enox
117.	SS Mortise lock with one dead bolt and pair of SS handles steel grade –SS304	Dorma/ Geze/ Enox/ Godrej
118.	SS Tower bolt	Dorma/ Geze/ Enox/ Godrej
119.	SS Butt hinges with ball bearing grade– SS304	Dorma/ Geze/ Enox/ Godrej
120.	Magic Eye	Dorma/ Geze/ Enox
121.	Equipment/Furniture	Godrej/Geeken/Durian
122.	Lever handle in SS 304 finish	Dorma/ Geze/ Enox/ Godrej
123.	Stainless Steel sliding door blots	Dorma/ Geze/ Enox/ Godrej
124.	Pull handle back to back of length 150mm of steel Grade-SS304	Dorma/ Geze/ Enox/ Godrej
125.	Aluminium level handles	Hardima/ Everite/ Godrej
SECTION 2 - PHE ITEMS		
126.	G.I / M. S Pipe	Tata/ Jindal (Hissar)/ Surya Prakash
127.	G. I Fittings	Unik/KS/ Zoloto/R-Brand/ Surya
128.	SS Pipes	Jindal/Tata/ J-Press
129.	HDPE Pipes	Reliance/ Jain Irrigation/ Oriplast/ Vertex/West Well/ Supreme/ Vectus
130.	DI Pipes	Electrosteel/ Jindal/Tata Ductura
131.	DI Fittings	Kartar/Electrosteel/ Kalinga
132.	CI Fittings	Neel/ Kartar/ Electrosteel
133.	CI Double flanged sluice valve	Kirloskar// Sondhi/ Kejriwal/ IVC
134.	Float Valve	IVC/ Leader/ Zoloto/ KSB
135.	cPVC Pipes & Fittings	Supreme /Prince / Astral
136.	PVC Pipes& Fittings	Supreme /Prince / Astral
137.	UPVC Pipe and Fittings	Supreme /Prince / Astral
138.	CP Fittings	Grohe/ Kohler/ Roca
139.	Pipe supports	HI-TECH pipe support
140.	Centrifugally Cast (Spun) Iron Pipes &Fittings	NECO/ SKF/Electrosteel/ Tata

141.	Centrifugally Cast (Spun) Ductile Iron Pipes & Fittings	Electro Steel/ Jindal (Hissar)/ Kalinga
142.	C. I Manhole covers, Frames & GI Gratings	NECO/ RIF/ BIC/ SKF
143.	SFRC Manhole covers & gratings	KK/ OCR/ Pargati/ T-CON/ AAGAM
144.	Gun Metal Valves, Globes	Kartar/ Castle/Zoloto
145.	CP Brass Fittings	KOHLER/ GROHE/ ROCA
146.	Sanitary ware	Kohler/ ROCA/ Duravit/ Hindware/ Jaquar
147.	Sanitary Fittings & Accessories	Kohler/ ROCA/ Duravit/ Hindware/ Jaquar
148.	Water Meter	ACT ARIS / NBI / DASHMESH
149.	Brass Stop & Bib Cock	Zoloto, Sant, L&K, Leader, Astral
150.	PVC Pipe & Fittings	Supreme/ Prince / Astral
151.	cPVC Pipes & Fittings	Supreme /Prince / Astral
152.	Non Return Valve (Check valve) 1/2 “ to 1¼”	Zoloto/ Sant/Leader
153.	Brass Ferrules	Dhawan Sanitary Udyog/ Kalsi/ Annapurna or equiv
154.	Water storage tank	Sintex/Polycon/ SPL Vectus
155.	Insulation for hot water pipes	Kaiflex/Armaflex/ Careflex/ Lloyd
156.	Insulation for external/ exposed hot water pipes	Kaiflex/Armaflex/ Careflex
157.	Pipe protection for external water supply pipes	Pypkote/ Armaflex/Makpolykote
158.	Stainless Steel Sink	Neelkanth/ Nirali /Jayna
159.	Stone ware pipes	Perfect /Hind/ Burn/ RK or Equiv
160.	Gully Traps	Perfect /Hind/ Burn/ RK or Equiv
161.	Atactic Polypropylene	STP/HTL /Hydro Tech/ Pidilite
162.	Ball Valves / wafer type valves	Zoloto/ Leader/ AIP
163.	Water Heater	Racold/ Venus/Jaquar/AO Smith/ Havells
164.	Air Release Valves	HAWA / BAJAJ / LEADER / GEORGE FISCHER
165.	Pipecoat	IWL Ltd , Pypkote STP
166.	Pressure reducing valve	HONEYWELL / HAWA /GEORGE FISCHER
167.	Gate valves/Non-Return valve	INTER VALVE / ZOLOTO / NVR /GEORGE FISCHER
168.	Hydropneumatic pumps	CRI / DP / GRUNDFOS
169.	Monoblock pumps	CRI / DP / GRUNDFOS / KIRLOSKAR
170.	Submersible pumps	CRI / GRUNDFOS/ KIRLOSKAR
171.	Liquid level indicator	INTERLINK/ SRIDHAN INTERNATIONAL/ SRIVINAYAKA/ GEORGE FISCHER
172.	Pipe protection tape underground	PYPCHAT / TAPEX or Equivalent approved by EIC NBCC
173.	Pipe protection tape(concealed)	PYPCHAT /TAPEX / or Equivalent approved by EIC NBCC
174.	Manhole frame & Cover in Fibre Reinforced concrete or in FRP	SOUTHERN CONCRETE INDUSTRIES/ AAGAM or Equivalent approved by EIC NBCC
175.	Pressurized float valves	VIKING / HAWA / GEORGE FISCHER
176.	Ball valve	RB/ INTER VALVE / NVR/API/ GEORGE FISCHER
177.	Air release valve	HAWA / BAJAJ / LEADER / GEORGE FISCHER
178.	Manhole PVC steps	SOUTHERN CONCRETE INDUSTRIES / AAGAM
179.	Butterfly valve	INTER VALVE / AUDCO / NVR/ GEORGE FISCHER

180.	CP Grating	NOWAY / or Equivalent approved by EIC NBCC
181.	Y Strainer	EMERALD / ZOLOTO/ INTER VALVE
182.	D.I Covers	CRESENT / NECO / or Equivalent approved by EIC NBCC
183.	Hume pipe	SOUTHERN CONCRETE INDUSTRIES/ MYSORE SPUN PIPES
PUMPS & WATER TREATMENT PLANT		
184.	Pressure sand filter	ION EXCHANGE / PENTAIR /CLAIRE FONTAINE
185.	Softener	ION EXCHANGE / LANXESS / PUROLITE
186.	Chlorine dozer	MILTON ROY / E-DOZE
187.	Level switch	INTERLINK/ SRIDHAN INTERNATIONAL/ SRI VINAYAKA
188.	Control panel	RANK ENGINEERING/ SIEMENS/ BHARAT BIJLEE/ L&T/ ABB/ APPLICATION
189.	PVC Piping	SUPREME /ASHIRVAD / ASTRAL
190.	Valves	INTER VALVE / AUDCO
191.	Flow meter	AQUAMATE / CAPSTAIN / ACTARIS
192.	Pumps	GRUNDFOS/ Xylem/WILLO/ KSB
193.	Submersible Drainage Pumps	KSB/GRUNDFOS/ Crompton
194.	G. I / M. S Pipes	TATA/JINDAL HISSAR/ SAIL
195.	G.I. Fittings	UNIK /Zoloto/ SS
196.	Ball Valves	ARCO/ SANT/ ZOLOTO
197.	Butterfly Valve	KSB/ SKS/ AUDCO
198.	C.I double flanged sluice valve	ZOLOTO/SANT/ CASTLE/ KARTAR
199.	Non Return Valve	ZOLOTO/SANT/ CASTLE/ KARTAR
200.	Y – Strainers	ZOLOTO/ SANT/ CASTLE KARTAR
201.	Float Switch	NOLTA /DANFOSS/HONEY WELL
202.	Pressure Gauge	FIEBIG /H. GURU/ Dan foss
203.	Dosing system	MILTON ROY/ ASIALMI/ GRUNDFOS
204.	Liquid Level Controllers/ Liquid Level Indicator	ADVANCE/ HONEY WELL/ DANFOSS
205.	Salt Saturator	Ion Exchange/ Renaissance Aqua/ PENTAIR/ WATCON
206.	Water Meter	Kent /Marshall /Sant
STP		
207.	G. I Pipes	TATA/ JINDAL HISSAR /Zenith
208.	G. I Fittings	UNIK/ Zoloto/ SS
209.	UPVC pipes	SUPREME /JAIN PIPES/ AKG/ PRINCE/ VECTUS
210.	UPVC pipe Pressure Fittings	CEPEX /ASTRAL /AKG/ VECTUS
211.	Pre-Fabricated Structural supports and clamps	CHILLY/ EASYFLEX/ CAMRY
212.	Paints	ASIAN PAINTS/ BERGER/ NEROLAC
213.	Gunmetal Fullway Valve	ZOLOTO /SANT/ CASTLE
214.	Ball Valve	ARCO/ CIM /CASTLE
215.	Butterfly Valve	KSB /SKS/ZOLOTO
216.	C. I double flanged sluice valve	KIRLOSKAR/ LEADER /SANT
217.	C. I Disk Type non return valves (65mm dia and above – Dual plate type)	KIRLOSKAR /LEADER/ SANT
218.	C. I Strainer more than 65mm dia	LEADER/ SANT/ CASTLE

219.	PVC Valves	CEPEX/ ASTRAL Audco
220.	C. I/D.I. Manholes cover	NECO /KARTAR /SKF
221.	Filter feed pump	GRUNDFOS /ITT /WILO/KSB
222.	Hydro-Pneumatic Pumping Systems (Flushing, Soft and garden hydrant)	GRUNDFOS/ ITT /WILO/KSB
223.	Submersible Sump Pumps for collection chamber, equalization tank, Plant room drainage, Filter backwash sump	KSB /GRUNDFOS /Crompton
224.	Pressure Transmitters/ Hydrostatic Level Indicators	WIKA/ SIEMENS
225.	Pressure Gauges	FIEBIG/ H. GURU/ WIKA
226.	Dosing System	ASIA LMI /MILTON ROY /GRUNDFOS
227.	Pressure sand & Activated carbon filter	M.S. Prefabricated
228.	Air Blowers	EVEREST/ BETA/ ABL
229.	Ultra Violet Disinfection for Treated Effluent	ALPHA /UV /SUKRUT/ NEOTEC
230.	Air Diffusers	BOBKAY/ MM AQUA/ REHAU
231.	Ultra Violet Disinfection for Treated Effluent	ALPHA UV/ SUKRUT/ NEOTEC
232.	Air Diffusers	BOBKAY/ MM AQUA/ REHAU
233.	MBBR media for Aeration tank	MM AQUA/ PP AQUA /TECPRO
234.	Dosing Pumps	MILTON ROY/ ASIA LMI /GRUNDFOS
235.	Sludge Pumps (Centrifugal)	Kirloskar/ GRUNDFOS/ ITT INDUSTRIES
236.	Sludge Pumps (Screw)	ROTO /UT PUMPS /Stork
237.	Tube Settler media	MM AQUA /PP AQUA /TECPRO
238.	Centrifuge	HILLER /ALPHA /HUMBOLDT /WEDAG
239.	Pressure Gauge	H. Guru/ FIEBEIG/ WIKA
240.	Level Gauge	H. Guru /FIEBEIG WIKA
241.	pH Meter	Hach/ Toshniwal/ IONIX
242.	Conductivity Meter	Hach /Toshniwal /IONIX
243.	DO Meter	Hach /Toshniwal/ IONIX
244.	TDS Metre	Hach /Toshniwal/IONIX
SECTION 3 - ELECTRICAL		
245.	Switchgear	Siemens /ABB/ Legrand/ L&T/ Schneider
246.	Air Circuit Breaker	Schneider(Masterpact NW (6.0A)/ Siemens(3WL(ETU 45B))/ ABB(Emax (PR123)/ L&T (U Power Omega (MTX3.5) /Legrand(DMX3 MP4 LSIG)
247.	LT PANEL/ PCC/ MCC/ MCBS/ APFC/ PANELS/ CONTROL PANELS	NEPTUNE SYSTEMS/ TRICOLITE/ ADLEC/ ADVANCE
248.	ACBs/ MCCBs	LEGRAND (DPX3)/ L&T (DU sine)/ SCHNEIDER(NSX)/ ABB (Tmax) / SIEMENS (3VL)
249.	MCBs	SCHNEIDER/ LEGRAND/ SIEMENS/ HAGER
250.	MPCB	Siemens (Sirius RV)/ Legrand (MPX3)/ Schneider(GV 2/3)/ ABB(MS)/ L&T(MOG)
251.	DLP Trunking	OBO/ Betterman /Legrand/ Schneider
252.	Floor Trunking / Raceway	MK Honeywell / Legrand/Schneider
253.	Lugs / Gland	Dowel /Comet /Braco

254.	Bus Ducts / Rising Mains	Legrand , Siemens, Advance-Anant Powertech, Schneider
255.	TTA Panels (Main LT Panels)	ABB ArTu (Neptune), Schneider Blockset (Advance),/Legrand - XL3 (OEM)
256.	Power Cables / Control Cables up to 11 KV Grade	Havells/ Polycab/ Finolex/
257.	Multifunction Meters	Schneider /Siemens /Neptune/ Secure
258.	RCCBs/ELCBs/RCBOs/ELMCB	SCHNEIDER(Acti9)/ LEGRAND(DX3)/ SIEMENS(Beta Guard 10KA)/ HAGER(H3)
259.	MCB Distribution boards/Pre-Wired DBS-Single/Three-Phase (Vertical & Horizontal -Single/ Double Door)	SCHNEIDER (Acti9)/ LEGRAND (Ekinox3)/ HAGER (Novello)/ SIEMENS (Beta Guard 10KA)
260.	Change over switch(Off load/On load)	L&T/ C&S/ HPL SOCOMEC/ INDOASSIAN/ABB
261.	Metal clad sheet steel Enclosure socket/plug box	LEGRAND/GWESIS/SIEMENS/ SCHNEIDER
262.	FRLS PVC Insulated copper wires/Cables (Un-armoured)	FINOLEX/ RR KABEL/ HAVELLS/ KEI/ POLYCAB
263.	Modular Plate Switches and sockets	CLIPSAL (ZENCELO)/ CRAB TREE (MURANO) /MK (ELEMENTS)/ LEGRAND (MYRIUS)
264.	Electronic energy meter single/Three phase	ENERCON/ ALACRITY/ L&T/SECURE/ SCHNEIDER/ HPL SOCOMEC/ SIEMENS/ ABB/ LEGRAND
265.	Internal Luminaire	PHILIPS/ HAVELLS/ CROMPTON/ BAJAJ
266.	External luminaire	BAJAJ/ HAVELLS/ PHILIPS/ POLYCAB
267.	PVC Conduit (ISI MARKED)	AVON PLAST/ ATUL/ POLYPACK/ PRECISION/ BEC/ AKG
268.	Flexible conduit	PLICA/AVON PLAST/ATHUL/ POLYPACK/ PRECISION
269.	Bakelite sheet	BAKELITE HYLAM LTD./ FORMICA/GREENLAM
270.	TV Coaxial cable	FINOLEX/ RR KABEL/ LAPP
271.	Control & Instrumentation cable	LEVITON, FINOLEX/ RPG/ SCHNEIDER/ CORD CABLES/POLYCAB// LAPP
272.	Voltage transformer	AE/ KAPPA/ C&S/INDOTEC/ FORBE MARSHALL/ SIEMENS/GILBERT & MAXWELL
273.	Current transformer	AE/ KAPPA/ PRAGATI/ BCH/ PRECISE/ C&S/ INDOTEC/ FORBE MARSHALL/GILBERT & MAXWELL/ SIEMENS
274.	Measuring instruments	VAISHNO/ MECO/ L&T/ RISHAB/ CONZERV/ ELMEASURE/ ABB
275.	Ceiling fan	CROMPTON/ BAJAJ/USHA/ HAVELLS/GEC/ ORIENT
276.	Exhaust fan/Axial flow fan/ Ventilation fan	CROMPTON/HAVELLS/ KHAITAN/ BAJAJ/GEC
277.	Tag block	KRONE/ERICSSON/POUYET
278.	LT Cable	CCI/ HAVELLS/ POLYCAB/ KEI/ GEMSCAB/ RR KABEL/ LAPP
279.	Automation power factor Control relay	L&T/ SIGMA/ BELUK/ NEPTUNE DUCATI/ ALACRITY/ CONZERV/ ABB/EPCOS/ ALSTOM/SYNTRON
280.	Capacitors	KHAITAN KHATAU JUNKER/ EPCOS/ GE/ SIEMENS/ VOLTAS/ CROMPTON/ L&T/

		NEPTUNE-DUCATI/ SCHNEIDER/ ABB/ LEGRAND
281.	Cable joining kits	RAYCHEM/ JAINSONS/ 3M/ DENSONS/ XICON/ BIRLA
282.	Cable trays	LEGRAND (Cablofil)/ GEWISS/ COOPER/ SCHNEIDER
283.	Contactors	L&T/ SIEMENS/ SCHNEIDER/ ABB/ LEGRAND
284.	Protection relays	L&T/ ABB/ SCHNEIDER/ C&S/SIEMENS/ GE/ ALSTOM/ LEGRAND
285.	Earth leakage relay	L&T/ PIC/ MINILEC/ ELMEASURE/ABB
286.	Single phasing device	L&T/ SIEMENS/ MINILEC/AE
287.	Push buttons	L&T/ SIEMENS/ BCH/ C&S/ ESSEN DEINKI/ TEKNIC/ABB
288.	Time relay device	EAPL/ SIEMENS/ L&T/ BCH/ C&S/ MINILEC/HAGER/ABB
289.	Selector switches & Rotary switches	KAYCEE/ L&T/ SIEMENS/ GE/ VAISHNO/ SALZER/ BCH/ABB
290.	Indicating lights	SIEMENS/ L&T/VAISHNO/ RAAS CONTROLS/ TEKNIC/ C&S, KAYCEE,ABB
291.	Terminals	ELMEX/ WAGO/ CONNECTWELL
292.	Multi data meter	ELMEASURE/ L&T/ ENERCON/ SCHNEIDER/ ABB/ SIEMENS/ NEPTUNE
293.	Lighting protection unit	ERICO/ INDELEC/ DUVAL MESSIEN/ ABB
294.	Telephone cable	HAVELLS/ FINOLEX/ ANCHOR
295.	Telephone/data outlets	CLIPSAL/ CRAB TREE/ MK, ANCHOR/ LEGRAND
SUBSTATION		
296.	Transformers	Crompton Greaves /Schneider/ ABB/ Siemens /VOLT amp
297.	HT Panels	Crompton Greaves/ Siemens/ ABB /Schneider/ Electric L&T
298.	H.T Termination & Joining Kit	RAY CHEM M-Seal Birla – 3M
299.	Cable gland s(Double compression with earthing links)/ Crimping lugs	DOWELLS/ COMET/ BRASCO/HMI/Electromac/Siemens/Jainsons
300.	Maintenance Free Earthing	Protec /Tercel JMV/ Ecosafe
DG SETS & RELATED ITEMS		
301.	Diesel Engine	Cummins/ Caterpillar/ MTU/ Kirloskar
302.	Alternator	Leroy Somer /KEC Stamford/ Toyo Denki
303.	Batteries	Panasonic /Exide/ Amaron
304.	Batteries Charger	Uptron /Volstat Electronics /Statcon AE
305.	PLC	Scheinder /Allen Bradle/Siemens
306.	NIS / NGR	Resitech/Essen RSI Switchgear/ Lachhman Electronics
INTERNAL WIRING		
307.	MCB, MCB DBS	Siemens/ Schneider Electric/ Legrand

308.	Modular Type light & power Accessories (Switches, socket etc.) M.S Switch Boxes	CLIPSAL (ZENCELO)/ CRAB TREE (MURANO) /MK (ELEMENTS)/ LEGRAND (MYRIUS)
309.	FRLS PVC Insulated Copper Wire	FINOLEX/ RR KABEL/ HAVELLS/ KEI/POLYCAB/AKG
310.	PVC Conduit	AKG/ BEC/ Polypack/ Prince ISI Marked
311.	M.S Conduit	BEC/ AKG/ NIC
312.	ESE Lighting protection system	Erico /Alltec/ Tercel/ Nimbus/ ABB
SECTION 4 -FIRE		
313.	FIRE PUMPS/ENGINE	KIRLOSKAR / MATHER & PLATT/GRUNDFOS
314.	M. S Pipe	Jindal/ Surya / TATA
315.	G. I Pipes	Jindal/ Surya/ TATA
316.	Forged Fittings	SS/VS/ True Forge
317.	Ball Valve / Gate Valve (Gunmetal)	Sant /Leader/ Zoloto/ CIM
318.	Butterfly valves	API/NVR / ZOLOTO / AUDCO
319.	Air Pressure Valve	Anergy/ Flemco/Castle/ SKS/Leader
320.	C. I Double flanged sluice valves	Kirloskar /Zoloto/ Sant /IVC
321.	C. I Double flanged Non-return valves	Kirloskar/ Zoloto /Sant/ IVC
322.	Dual Plate / Wafer Type Non-return valves	Kirloskar/ Zoloto/ Sant/ IVC
323.	Fire Extinguisher	CEASE FIRE/SAFEX / MINIMAX /NEWAGE
324.	First Aid Hose Reel Drum	Superex /Newage/ Safex /Safe Fire
325.	Thermo Plastic Hose Reels for Drums	Superex /Newage/ Safex
326.	R.R.L Hose & C.P Hose	Superex /Newage/ Eversafe/ Safe Fire
327.	Branch Pipe, Nozzle, Coupling etc.	Minimax /Lifeguard/ Safeguard/ Safe Fire
328.	Landing Valves	Superex /Newage /Eversafe/ Safe Fire
329.	Fire Brigade Connections	Superex /Newage/Eversafe/Minimax /Safe Fire
330.	Hose Box	Superex /Newage /Eversafe
331.	Sprinkler & Rosette Plates	Tyco /Viking /HD Spray Safe
332.	Motors for Fire Pumps	Siemens/Kirloskar/ Crompton/ ABB
333.	Electrical Switch Gears	Siemens /Schneider/ ABB/ L&T
334.	Power and Control Cables	Universal /Polycab /Havels/ Finolex/ Batra Henlay/ Grandlay
335.	Control Panel of Terrace Pumps	Advance panel & Switchgear /Adlec / Tricolite/ Neptune
336.	Voltmeter & Ammeter	Schneider /Neptune/ Rishabh Conserve
337.	Indicating Lamps & Push buttons	L&T / SEIMENS
338.	CT	AE /Kappa/ Nutech Electrical
339.	MCCB / MPCB / MCB	Siemens/ Schneider /Legrand
340.	Contractors/ TIMES, OVERLOAD Contractors/ TIMES, OVERLOAD RELAYS/ STARTER	L&T /Siemens /Schneider/ Legrand
341.	Foot valve with Strainer	Kirloskar /Leader/ Zoloto
342.	Flexible Connector (Drop) for Sprinkler	Easyflex/Viking/ Newage
343.	Flow Switches	NOTIFIER /HONEYWELL
344.	Annunciation panels	Neptune/ Tricolite /Adlec
345.	Single phase preventer	Minilac /L&T /Siemens
346.	Inspector Test valve	Viking /Tyco/ Hd
347.	Pre-Fabricated Structural supports and clamps	Chilly/ Hitech /Camry /Easyflex

348.	Pressure gauge	H - GURU /BEIG
349.	Alarm Valve	Viking /Tyco/HD
350.	Dash fasteners/ SS Cramps	Hilti/ Fischer/ Fasteners India
351.	Welding Electrodes	Advani /Essab /Mangalam
352.	Anti-vibration Pads & suction & delivery flexible pipe connectors	Easyflex/ Resistoflex /Dunlop
353.	Reinforcement Steel / Structural Steel/ Steel Plates	SAIL /Tata Steel Ltd /RINL /Jindal Steel & Power JSW Steel Ltd.
354.	Electrical motors	KIRLOSKAR/SEIMENS/NGEF/CROMPTON//GR UNDFOS
355.	Booster pump	KIRLOSKAR / MATHER & PLATT//GRUNDFOS
356.	MS fittings	JAINSONS /VS/B&M
357.	Ball valve (15-40mm dia)	ZOOTO / HAWA/ VB/JAINSONS
358.	Sluice valves	KIRLOSKAR / ZOOTO API/NVR
359.	Non-Return Valve- Flap type cast iron	KIRLOSKAR / ZOOTO API/NVR
360.	Canvass hose	NEWAGE / MINIMAX
361.	Hardware for Fire Check Door	Dorma/ AssaAbloy/ Hafale
362.	Fire Paint	Asian/Jotun/ Akzonobel
363.	Fire rated doors	iclean /Promat /Shakti /Navair
364.	Pressure switch	DANFOSS / INDFOSS
365.	PVC Insulated copper wires	FINOLEX / UNIVERSAL / CCI
366.	Cables	FINOLEX / UNIVERSAL / CCI
367.	Over load relays	L&T/ SCHNEIDER/ LEGRAND
368.	Single phase preventer	L&T / SEIMENS
369.	Sprinkler head	TYCO / RAPIDROP/ VIKING
370.	Sprinkler ICV	TYCO / RAPIDROP/ VIKING
371.	Gunmetal branch pipe	NEWAGE / WINCO /AAG
372.	Gun metal nozzle	NEWAGE / WINCO/AAG
373.	Air release valve	RB / TBS / VB
374.	Rubber hose reel	EVER SAFE / MINIMAX
375.	Fire buckets	SAFEX / MINIMAX
376.	Suction strainer 'Y'/pot	ANIL / UPADYAYA
377.	Single headed hydrant valve	NEWAGE / WINCO / MINIMAX
378.	Fire rated vision Panels	Pilkington/SCHOTT/ FERILITE/Saint Gobain/ Glaverbel
379.	Fire Sealant	Hilti /3M/ India Fischer
SECTION 5 - HVAC		
380.	Pumps	Grundfoss/ Armstrong/Kirloskar/ Xylem
381.	Variable pumping system	Grundfoss/ Armstrong/Xylem
382.	Heat Recovery Wheel	DRI /Ostberg/ Flaktwood
383.	Axial flow fan	Krugar/ Greenheck/ Systemair/ Woltar
384.	VFD	VTS/Danfoss/ ABB/ Fuji
385.	AHU / FCU Motor	ABB/Crompton/ Siemens
386.	Actuator Assembly	Belimo/Danfoss/ Siemens
387.	Electrical Panel	Adlec/Tricolite/Advance Panel &Switchgear
388.	PACs	Stulz/ Emerson/ Blue Box
389.	VRV /VRF System – Inverter type	Daikin/CARRIER/ MITSUBISHI /Voltas
390.	VRV /VRF Indoor units	Daikin/CARRIER/ MITSUBISHI /Voltas
391.	CPVC / HDPE / PVC Pipes	FINOLEX /SUPREME /ASHIRVAD/ASTRAL
392.	Factory fabricated ducts	ROLASTAR / ZICO SEVEN STAR / ATCO
393.	Duct supports/ Anchors fasteners	GRIPPLE / HILTTI/ HI TECH / RAWLPLUG

394.	Diffusers/ Grills/ Slot diffusers/ Exhaust/ Disc valves/ VCD/ Butterfly damper/ Louvers	AIRMASTER / DYNACRAFT / TROX / RUSKIN/TITUS
395.	Flexible ducts	SUPA FLEX/ KARTHILA/ SEVEN STAR/ TWIGA/ TITUS
396.	Fibre glass insulation	UP TWIGA / OWENS CORNING / KIMMCO
397.	PUF Insulation	BEARDSSELL / LLOYD / MALANPUR
398.	Copper pipes	NIPPON / RAJCO
399.	Copper pipe-insulation	K-FLEX/ARMAFLEX
400.	Duct thermal insulation	ARMAFLEX/ K FLEX/ EUROBATEX
401.	Fresh air & Exhaust – Inline fans	KRUGER/ NICOTRA/ GREENHECK/ CARRYAIRE/ OSTBERG/ SPHERE/ AIRFLOW
402.	Exhaust – Propeller fan	KRUGER/ NICOTRA/ GREENHECK/ CARRYAIRE/ DASPASS/ CROMPTON
403.	Pressurisation fan	KRUGER/ NICOTRA/ GREENHECK/ CARRYAIRE
404.	Cable/ Refrigerant trays	UNITECH, WIBE,PROFAB, STEELWAYS,BHARTI/
405.	Volume control damper	AIRMASTER/ AITECTH/ SYSTEMAIR/ COSMOS/ AJANTA
406.	Duct sealant	HILTI / 3M / PROMAT / URJA
407.	GI Sheets	TATA/ JINDAL
408.	Adhesive	ARMAFLEX
409.	Jet fans	SYSTEMAIR / AIROVENT/FLAKT WOODS
410.	Smoke spill axial fans	KRUGER / NICOTRA / GREENHECK / CARRYAIRE
411.	MCBS	SCHNEIDER / SIEMENS/ Legrand - DX3
412.	Cables	KEI / HAVELLS / FINOLEX
413.	Paints	ICI/BERGER
414.	Grilles / Diffuser / Fire Dampers	Caryaire/Systemair/Tristar Mapro
415.	Aluminium Sheet	Nalco /Hindalco/ Balco
416.	Cable Tray	SCHNEIDER/ LEGRAND/ COOPER/ GEWISS
PIPE		
417.	M. S	Tata /Jindal Hissar/ Jindal Star/ SAIL
418.	G. I	Tata /SAIL/ Jindal Hissar
419.	Flexible pipe connection	Resistoflex/ Easyflex /Kanwal
420.	Refrigerant Piping	Mandev /Mex Flow/ Mehta Tubes or Equiv
421.	UPVC pipes	SUPREME /ASHIRVAD / ASTRAL
INSULATION		
422.	Glass Wool	U.P Twiga/Owen Corning/K-Wool
423.	Nitrile rubber	Armacell/K-flex/Aerocell
424.	Expanded polystyrene	SHI/Beardshell/ Styrene packaging
425.	Vibration isolator pads	Resistoflex/ Kanwal/ Easyflex
426.	Paracoat BPC	Paramount/ Pidilite/ Indiana Polycoat
SECTION 6 - LIFTS		
427.	Lifts	MITSUBHUSHI/ SCHINDLER/ KONE /OTIS
FIRE DETECTION & ALARM SYSTEM		

428.	Detectors & Devices – Intelligent multi-criteria detector, smoke detectors, heat detectors, duct detectors, control module, monitor module, fault isolator, hooters etc. Addressable Main Fire Alarm Panel with Digital voice evacuation system	Notifier/ Edwards /Siemens/ Honeywell/ATEIS
429.	Fire Survival Cable	Rallison /Polycab /Bonton/ Batra Henlay/ No Burn/ LAPP
430.	UPS System	APC/ Emerson/ Schneider /Mitsubishi /Siemens/ NUMERIC

DATA, TELEPHONE NETWORK SYSTEM

S.No.	Equipment Detail	Makes & Models
431.	Cat 6a F/UTP Cables	Belden/Siemon/Panduit/Corning/Co Mscope/ Molex
432.	Cat 6a F/UTP I/O	Belden/Siemon/Panduit/Corning/Co Mscope/ Molex
433.	Jack Panel Cat 6a F/UTP	Belden/Siemon/Panduit/Corning/Co Mscope/ Molex
434.	Cat 6a F/UTP Patch Cords	Belden/Siemon/Panduit/Corning/Co Mscope/ Molex
435.	Fiber Cables & Liu	Belden/Siemon/Panduit/Corning/Co Mscope/ Molex
436.	Face Plate	Belden/Siemon/Panduit/Corning/Co Mscope/ Molex
437.	Cat 6 UTP Cable And Components For CCTV	Belden/Siemon/Panduit/Corning/Co Mscope/ Molex
438.	Rack Components	Comrack/ Rittal/ Valrack/ Apw / Powerride
439.	CCTV	Axis / Impulse / Idis / Bosch / Honneywell
440.	EPABX	Alkatel / Siemens / Nec / Avaya/ Panasonic
441.	All Other Items Not Covered Above	Approved By Engineer-In-Charge.

NOTE:

- i) All makes shall further confirm to standards specification of each item as mentioned in the Technical specifications of Tender Documents.
- ii) The above list does not include makes of sub-brands.

SECTION-VI
SAFETY CODE

SECTION – VI SAFETY CODES

1. Suitable scaffolds should be provided for workmen for all works that cannot safely be done from the ground, or from solid construction except such short period work as can be done safely from ladders. When a ladder is used an extra mazdoor shall be engaged for holding the ladder and if the ladder is used for carrying materials as well, suitable footholds and handholds shall be provided on the ladder and the ladder shall be given an inclination not steeper than 1/4 to 1 (1/4 horizontal and 1 vertical).
2. Scaffolding or staging more than 3.6 m. (12 feet) above the ground or floor, swung or suspended from an overhead support or erected with stationary support shall have a guard rail properly attached or bolted, braced and otherwise secured at least 90 cm. (3 feet) high above the floor or platform of such scaffolding or staging and extending along the entire length of the outside and ends thereof with only such opening as may be necessary for the delivery of materials. Such scaffolding or staging shall be so fastened as to prevent it from swaying from the building or structure.
3. Working platform, gangways, and stairways should be so constructed that they should not sag unduly or unequally, and if the height of the platform or the gangway or the stairway is more than 3.6 m. (12 feet) above ground level or floor level, they should be closely boarded, should have adequate width and should be suitably fastened as described in (ii) above.
4. Every opening in the floor of a building or in a working platform shall be provided with suitable means to prevent the fall of persons or materials by providing suitable fencing or railing whose minimum height shall be 90 cm. (3 feet).
5. Safe means of access shall be provided to all working platforms and other working places. Every ladder shall be securely fixed. No portable single ladder shall be over 9 m in length while the width between side rails in rung ladder shall in no case be less than 29 cm for ladder up to and including 3 m in length. For longer ladders this width should be increased at least 1/4" for each additional 30 cm of length. Uniform step spacing or not more than 30 cm. shall be kept. Adequate precautions shall be taken to prevent danger from electrical equipment. No materials on any of the sites or work shall be so stacked or placed as to cause danger or inconvenience to any person or the public. The Contractor shall provide all necessary fencing and lights to protect the public from accident, and shall be bound to bear the expenses of defense of every suit, action or other proceedings at law that may be brought by any persons for injury sustained owing to neglect of the above precautions and to pay any damages and cost which may be awarded in any such suit, action or proceedings to any such persons or which may, with the consent of the Contractor, be paid to compensate any claim by any such person.
6. Excavation and trenching: All trenches, 1.2 m or more in depth, shall at all times be Supplied with at least one ladder for each 30m in length or fraction thereof, Ladder shall extend from bottom of the trench to at least 90 cm above the surface of the ground. The side of the trenches which are 1.5 m or more in the depth shall be stepped back to give suitable slope or securely held by timber bracing, so as to avoid the danger of sides collapsing. The excavated materials shall not be placed within 1.5 m of the edges of the trench or half of the depth of the trench whichever is more. Cutting shall be done from top to bottom. Under no circumstances undermining or under cutting shall be done.
7. Demolition: Before any demolition work is commenced and also during the progress of the work: -
 - I. All roads and open areas adjacent to the work site shall either be closed or suitably protected.
 - II. No electric cable or apparatus which is liable to be a source of danger or a cable or apparatus used by the operator shall remain electrically charged.
 - III. All practical steps shall be taken to prevent danger to persons employed from risk of fire or explosion or flooding. No floor, roof or other part of the building shall be so overloaded with debris or materials as to render it unsafe.

8. All necessary personal safety equipment as considered adequate by the Engineer-in-Charge should be kept available for the use of the person employed on the site and maintained in a condition suitable for immediate use, and the Contractor should take adequate steps to ensure proper use of equipment by those concerned. The following safety equipment shall invariably be provided:
 - I. Workers employed on mixing asphaltic materials, cement and lime mortars shall be provided with protective footwear and protective goggles.
 - II. Those engaged in white washing and mixing or stacking of cement bags or any material which is injurious to the eyes shall be provided with protective goggles.
 - III. Those engaged in welding works shall be provided with welders protective eye shields.
 - IV. Stone breakers shall be provided with protective goggles and protective clothing and seated at sufficiently safe intervals.
 - V. When workers are employed in sewers and manholes, which are in active use, the Contractors shall ensure that the manhole covers are opened and are ventilated at least for an hour before the workers are allowed to get into the manholes, and the manholes so opened shall be cordoned off with suitable railing and provided with warning signals or boards to prevent accident to the public.

In addition the Contractor shall ensure that the following safety measures are adhered to: Entry for workers into the line shall not be allowed except under supervision of the EIC or his representative.

- I. At least 5 to 6 manholes upstream and downstream should be kept open for at least 2 to 3 hours before any man is allowed to enter into the manhole for working inside.
- II. Before entry, presence of Toxic gases should be tested by inserting wet lead acetate paper which changes colour in the presence of such gases and gives indication of their presence
- III. Presence of Oxygen should be verified by lowering a detector lamp into the manhole. In case, no Oxygen is found inside the sewer line, workers should be sent only with Oxygen kit.
- IV. Safety belt with rope should be provided to the workers. While working inside the manholes, such rope should be handled by two men standing outside to enable him to be pulled out during emergency.
- V. The area should be barricaded or cordoned off by suitable means to avoid mishaps of any kind. Proper warning signs should be displayed for the safety of the public whenever cleaning works are undertaken during night or day.
- VI. No smoking or open flames shall be allowed near the blocked manhole being leaned.
- VII. The malba obtained on account of cleaning of blocked manholes and sewer lines should be immediately removed to avoid accidents on account of slippery nature of the malba.
- VIII. Workers should not be allowed to work inside the manhole continuously. He should be given rest intermittently. The Engineer-in-Charge may decide the time up to which a worker may be allowed to work continuously inside the manhole.
- IX. Gas masks with Oxygen Cylinder should be kept at site for use in emergency
- X. Air-blowers should be used for flow of fresh air through the manholes. Whenever called for, portable air blowers are recommended for ventilating the manholes. The motors for which shall be vapour proof and of totally enclosed type. Non-sparking gas engines also could be used but they should be placed at least 2 metres away from the opening and on the leeward side protected from wind so that they will not be a source of friction on any inflammable gas that might be present.
- XI. The workers engaged for cleaning the manholes / sewers should be properly trained before allowing to work in the manhole.
- XII. The workers shall be provided with gumboots or non-sparking shoes bump helmets and glows gas masks and non-sparking tools safety lights and gas masks and portable air blowers (when necessary). They must be supplied with barrier cream for anointing the limbs before working inside the sewer line.

- XIII. Workmen descending a manhole shall try each ladder stop or rung carefully before putting his full weight on it to guard against insecure fastening due to corrosion of the rungs fixed to manhole.
- XIV. If a man has received a physical injury, he should be brought out of the sewer immediately and adequate medical aid should be provided to him.
- XV. The extent to which these precautions are to be taken depend on individual situation but the decision of the Engineer-in-Charge regarding the steps to be taken in this regard in an individual case will be final. XVI.

The Contractor shall not employ men and women below the age of 18 years the work of painting with products containing lead in any form. Wherever men above the age of 18 are employed on the work of lead painting, the following precautions should be taken:

No paint containing lead or lead products shall be used except in the form of paste or readymade paint.

Suitable face masks should be supplied for use by the workers when paint is applied in the form of spray or a surface having lead paint dry rubbed and scrapped.

Overalls shall be supplied by the Contractors to the workmen and adequate facilities shall be provided to enable the working painters to wash during and on cessation of work.

9. The Contractor shall not employ women and men below the age of 18 on the work of painting with product containing lead in any form. Wherever men above the age of 18 are employed on the work of lead painting, the following principles must be observed for such use White lead, sulphate of lead, or product containing these pigment, shall not be used in painting operation, except in the form of paste or of paint ready for use.

- I. Measures shall be taken, wherever required in order to prevent danger arising from the application of a paint in the form of spray.
- II. Measures shall be taken, wherever practicable, to prevent danger arising out of from dust caused by dry rubbing down and scrapping.
- III. Adequate facilities shall be provided to enable working painters to wash during and on cessation of work.
- IV. Overalls shall be worn by working painters during the whole of the working period.
- V. Suitable arrangements shall be made to prevent clothing put off during working hours, being soiled by painting materials.
- VI. Cases of lead poisoning and suspected lead poisoning shall be notified and shall be subsequently verified by a medical man appointed by the competent authority of the Department.

VII. The WAPCOS Limited may require, when necessary, medical examination of workers.

VIII. Instruction with regard to special hygienic precautions to be taken in the painting trade shall be distributed to working painters.

10. When the work is done near any place where there is risk of drowning, all necessary equipment should be provided and kept ready for use and all necessary steps taken for prompt rescue of any person in danger and adequate provision should be made for prompt first-aid treatment of all injuries likely to be obtained during the course of the work.

11. Use of hoisting machines and tackle including their attachments, anchorage and supports shall conform to the following standards or conditions:

- I. These shall be of good mechanical construction, sound material and adequate strength and free from patent defects and shall be kept repaired and in good working order.
- II. Every rope used in hoisting or lowering materials or as a means of suspension shall be of durable quality and adequate strength, and free from patent defects.

Every crane driver or hoisting appliance operator shall be properly qualified and no person under the age of 21 years should be in charge of any hoisting machine including any scaffolding winch or give signals to operator.

In case of every hoisting machine and of every chain ring hook, shackle swivel and pulley block used in hoisting or as means of suspension the safe working load shall be ascertained by adequate means. Every hoisting machine and all gear referred to above shall be plainly marked with the state working load. In case of a hoisting machine having a variable safe

working load, each safe working load and the conditions under which it is applicable shall be clearly indicated. No part of any machine or any gear referred to above in this paragraph shall be loaded beyond the safe working load except for the purpose of testing.

In case of departmental machines, the safe working load shall be noticed by the Electrical Engineer- in Charge. As regards Contractors machines the Contractors shall notify the safe working load of the machine to the Engineer-in- Charge whenever he brings any machinery to site of work and get it verified by the Electrical Engineer concerned.

12. Motors, gearing, transmission, electrical wiring and other dangerous parts of hoisting appliances should be provided with efficient safe-guards. Hoisting appliances should be provided with such means as will reduce to the minimum the risk of accidental descent of the load. Adequate precautions should be taken to reduce to the minimum the risk of any part of a suspended load becoming accidentally displaced. When workers are employed on electrical installations which are already energized, insulating mats, wearing apparel, such as gloves, sleeves and boots as may be necessary should be provided. The workers should not wear any rings, watches and carry keys or other materials which are the good conductors of electricity.
13. All scaffolds, ladders and other safety devices mentioned or described herein shall be maintained in safe condition and no scaffold, ladder or equipment shall be altered or removed while it is in use. Adequate washing facilities should be provided at or near places of work.
14. These safety provisions should be brought to the notice of all concerned by display on a notice board at a prominent place at work spot the person responsible for compliance of the safety code shall be named therein by the Contractor.
15. To ensure effective enforcement of the rules and regulations relating to safety precautions the arrangements made by the Contractor shall be open to inspection by the Labour Officer or Engineer-in- Charge of the Department or their representatives.
16. Notwithstanding the above Clauses from (1) to (14) there is nothing in these to exempt the Contractor from the operations of any other Act or Rule in force in the Republic of India.

SECTION-VII

SAFETY WITH SCAFFOLDING

SECTION –VII SAFETY WITH SCAFFOLDING**1. Introduction:**

1.1. Following paragraphs deals with safety regulations and precautions to be followed in the construction, use, maintenance, etc. of scaffolds. This will serve as a guide for users of scaffolds in the construction and maintenance operations.

1.2 Suitable scaffolds are used for performing work that cannot be done from the ground, part of a permanent structure, ladder or other available means of support.

Scaffolds are used in many construction and maintenance operations. The fall of persons is most common hazard accompanying the use of scaffolds because of the height usually involved.

2. General Requirements:

2.1. Every scaffold and its supporting members should be designed to support given load, with a safety factor of at least four. No alterations shall be made that might impair the strength of such structures, no improvised, make-shift or substandard scaffold should be permitted even for the most temporary use.

2.2 All work in connection with such structures, including construction, alteration and removal should be carefully done under the direction and supervision of persons who have had experience in such works.

3. Materials of Construction:

3.1 Every scaffold and every part thereof, including supports, should be of good construction, sound material, of adequate strength for the purpose which it is meant to be used and should be properly maintained.

3.2 Planks should be laid flat with an overlap lengthwise of at least 30 cm. With the centre of the overlap directly over a bearer. Boards and planks used for floors should be of uniform thickness, closely laid and securely fastened in place.

3.3 All lumber used in the construction of scaffolds should be sound, straight-grained, free from cross-grains, shakes and loose or dead knots. It should also be free from dry rot, large checks, wormholes or other defects that impair its strength or durability.

3.4 All nails used in the construction of scaffolds, staging and supports should be of ample size and use sufficient quantities at each connection to develop the designed strength of the scaffold. Nails should penetrate to the holding piece to a depth of at least 12 times the diameter of nail.

3.5 Barrels, boxes, loose tiles blocks or other unstable objects should not be used to support planks used as working platforms.

4. Platforms, Railings and Tee-Boards:

The minimum uniformly distributed design load per Sq. m. of platforms should be 250 kg. Any concentrated load at any point in the span should not exceed the designed uniformly distributed load. Planks should not be less than 50 mm thick.

4.1 Thereafter, on every side of every scaffolding, platform and ramp more than 2M above the surrounding ground or solid construction, or adjacent to deep holes, excavations, railroad tracks, high tension electrical wires, should be provided with a substantial guardrail of standard construction consisting of top and intermediate rails and toe-boards all supported by posts and securely connected to scaffold at intervals not exceeding 2.4 M (See Figure-1).

4.2 The width of the scaffolds should be such as to provide a clear walkway, 50 cm wide. If part of the width of the scaffold is to be used for keeping materials such as brick, mortar or lumber, the scaffold should be made wider so that there can be provided a walkway of the required width.

4.3 Where scaffolds are erected over sidewalks or over areas in which persons must work or pass, the space between the railing and toe-board should be fitted with side screens.

4.4 There should be a screen or other protections suspended from the scaffold to catch materials that may fall from above. Screens should extend beyond the edge of the scaffold to catch any materials that may fall over the edges.

5. Means of Access:

A safe and convenient means of access should be provided to the platform or scaffold. This requirement does not apply to swinging scaffolds or those with convenient access from adjacent floors (see Figure-2).

Means of access may be a portable ladder, fixed ladder, ramp, or it may be an airstairway. The use of cross braces or framework as means of access to the working surfaces should not be permitted.

If scaffolds are to be used to great extent or for long periods of time, a regular plank stairway wide enough to allow two persons to pass should be erected. Such stairways should have handrails on both sides.

No stairway or run of slope exceeding 2 in 3 should be used.

Where the slope of an airstairway or run renders additional foothold necessary, and wherever the slope is more than 1 in 4, there should be provided proper stepping laths which should have a minimum section of 50x30mm and be placed at maximum interval of 45cm and be of length to cover the full width of the stairway of run, except that they may be interrupted over an width not exceeding 10cm to facilitate movement.

6. Overhead Protection:

6.1. Overhead protection should be provided on the scaffold whenever persons are working at higher places. This protection should not exceed 3M above the scaffold floor and should be of planks or other suitable materials.

7. Use of Scaffolds:

7.1. Good housekeeping should be maintained at all times upon scaffolding, platforms and ramps. Excessive storage of materials thereon should be avoided. Care must be taken to avoid accumulating of small objects such as boards, tools, pieces of reinforcing steel, waste concrete which may easily be disturbed on knock-off. Handrails should be kept in good repair and securely nailed or otherwise fastened down. Scaffold should be cleared of all tools, materials and rubbish at the end of each working day/shift.

7.2 Persons should not be permitted on scaffolds when the platform or guard rails are slippery. Persons should not be permitted to work on scaffolds during a storm or strong winds.

7.3 Suspended scaffolds should never be used for the storage of stone or heavy materials. Two or more swinging scaffolds should not at any time be combined into one by bridging the distance between them with planks or any other form of connection. Lifelines securely fastened from above should be provided for each person working on a swinging scaffold. Safety belts should be tied to the lifelines (See Figure-3).

8. Inspection:

8.1. Scaffold should have remained in position normally for many weeks, they must be inspected at least once a week to make sure that nothing has gone wrong since erection. In addition, they must always be inspected after a spell of bad weather which might have affected their stability.

8.2 The inspections must be carried out by someone who knows the faults to look for and how they may be put right. It is important to know that the work of inspection has been completed and what faults have been found, therefore the results of each inspection must, therefore be recorded. Any scaffold damaged or weakened from any cause should immediately be repaired and persons should not be allowed to use it until repairs have been completed.

9. Dismantling:

9.1. The dismantling of scaffold should be carefully done under experienced supervision. Care should be taken not to drop small, loose objects when removing scaffold planks. All nails should be promptly removed from scaffold planks and the planks safely piled.

10. Precautions against particular Hazards:

10.1. Care should be taken to see that no uninsulated electric wire exists within 3m of the working platform, stairways, etc. of the scaffold.

10.2. While carrying bars, rods or pipes of any conducting material of length greater than 3 M. in the vicinity of electric wires, special care should be taken that these bars do not touch the electric wires.

10.3. Care should be taken against any possibility of wooden scaffold catching fire. In suspended scaffolds, if a blow torch or other flame is used for removing paints, only wire ropes not less than 10mm in diameter should be used.

Care should be taken to see that no part of a scaffold is struck by a truck or other heavy moving equipment and no material should be dumped against it.

10.4. Scaffolds on thoroughfare should be provided with light.

10.5. Access to cable tunnels, hydrants, etc. should remain free at all times.

10.6. Care should be taken from damaging underground cables and equipment. This is especially important when parts of scaffolds for other fasteners have to be driven in the ground.

Guard Rails

The rear outer side of the scaffold should be provided with a substantial guard rail of standard construction.

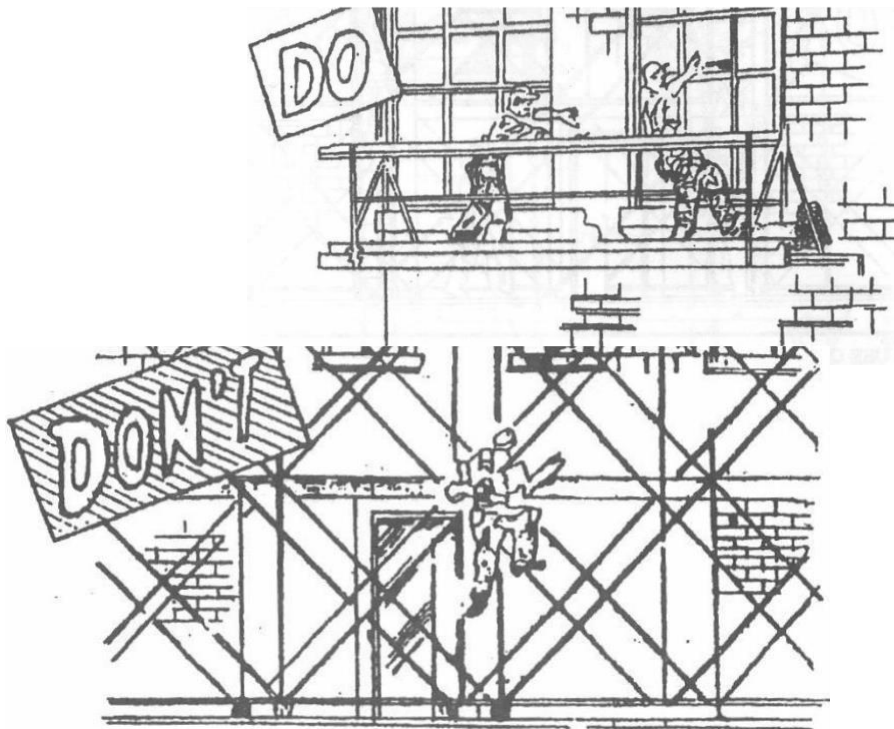

Person should not be allowed to work on scaffolds where the edges are unguarded. An slightest slip will result in serious injury or even death.



Figure- 1:

A safe and convenient means of access should be provided to the scaffold.

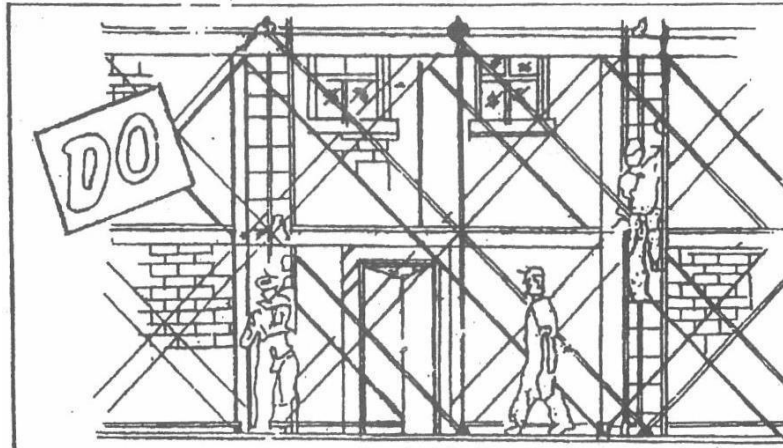

The use of cross braces or framework as means of access to working surfaces should not be permitted.

Figure- 2

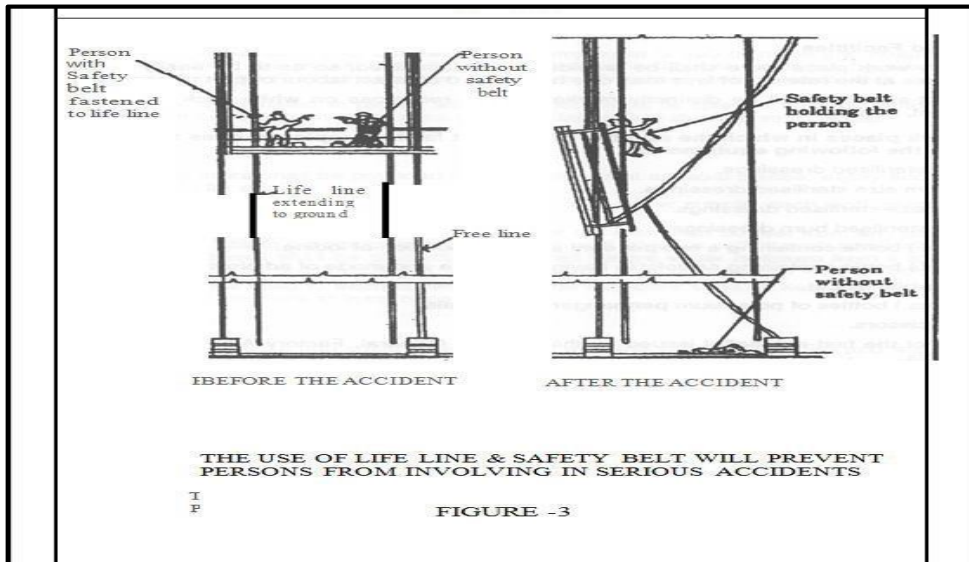

SECTION-VIII
MODEL RULES

SECTION – VIII MODEL RULES**MODEL RULES FOR THE PROTECTION OF HEALTH AND SANITARY
ARRANGEMENTS FOR WORKERS EMPLOYED**

1. Application: These rules shall apply to all buildings and construction work in charge of Department where twenty or more workers are ordinarily employed or are proposed to be employed on any day during the period during which the Contract work is progress.

2. Definition: Workplace means a place where twenty or more workers are ordinarily employed in connection with construction work on any day during the period during which the Contract work is progress.

3. First-Aid Facilities:

I. At every work place there shall be provided and maintained, so as to be easily accessible during working hours, first-aid boxes at the rate of not less than one box for 150 Contract labour or part thereof ordinarily employed.

II. The first-aid box shall be distinctly marked with a red cross on white back ground and shall contain the following equipment, namely:

A. For workplaces in which the number of Contract labor employed does not exceed 50, each first aid box shall contain following equipment:

- 6 small sterilised dressings.
- 3 medium size sterilised dressings.
- 3 large size sterilised dressings.
- 3 large sterilised burn dressings.
- 1 (30 ml.) bottle containing a two per cent alcoholic solution of iodine.
- 1 (30 ml.) bottle containing Sal volatile having the dose and mode of administration indicated on the label.
- 1 snake-bite lancet.
- 1 (30 gms.) bottles of potassium permanganate crystals.
- 1 pair scissors.
- 1 copy of the first-aid leaflet issued by the Director General, Factory Advice Service and Labour Institutes, Government of India.
- 1 bottle containing 100 tablets (each of 5 gms.) of aspirin.
- Ointment for burns.
- A bottle of suitable surgical antiseptic solution.

B. For workplaces in which the number of Contract labour exceeds 50, each first aid box shall contain following equipment:

- 12 small sterilised dressings.
- 6 medium size sterilised dressings.
- 6 large size sterilised dressings.
- 6 large size sterilised burn dressings.
- 6 (15 gms.) packets sterilised cotton wool.
- 1 (60 ml.) bottle containing a two per cent alcoholic solution of iodine.
- 1 (60 ml.) bottle containing salvolatile having the dose and mode of administration indicated on the label.
- 1 roll of adhesive plaster.

- 1 snake-bite lancet.
- 1 (30 gms.) bottle of potassium permanganate crystals.
- 1 pair scissors.
- 1 copy of the First-Aid leaflet issued by the Director General, Factory Advice Service and Labour Institute, Government of India.
- A bottle containing 100 tablets (each of 5 gms.) of aspirin.
- Ointment for burns.
- A bottle of suitable surgical antiseptic solution.

I. Adequate arrangements shall be made for immediate recoument of the equipment when necessary.

II. Nothing except the prescribed contents shall be kept in the first aid box.

III. The First-Aid box shall be kept in charge of a responsible person who shall always be readily available during the working hours of the work place.

IV. A person in charge of the First-Aid box shall be a person trained in First-Aid treatment, in work places where the number of Contract labour employed is 150 or more.

V. In work places where the number of Contract labour employed is 500 or more and hospital facilities are not available within easy distance from the works, First-Aid posts shall be established and run by a trained compounder. The compounder shall be on duty and shall be available at all hours when the workers are at work.

VI. Where work places are situated in places which are not towns or cities, a suitable motor transport shall be kept readily available to carry injured person or persons suddenly taken ill to the nearest hospital.

4. Drinking Water:

I. In every work place, there shall be provided and maintained at suitable places, easily accessible to labour, a sufficient supply of cold water fit for drinking.

II. Where drinking water is obtained from an intermittent public water supply, each work place shall be provided with storage where such drinking water shall be stored.

III. Every water supply or storage shall be at a distance of not less than 50 feet from any latrine, drain or other source of pollution. Where water has to be drawn from an existing well which is within such proximity of latrine, drain or any other source of pollution, the well shall be properly chlorinated before water is drawn from it for drinking. All such wells shall be entirely closed in and be provided with a trap-door which shall be dust and water proof.

IV. A reliable pump shall be fitted to each covered well, the trap-door shall be kept locked and opened only for cleaning or inspection which shall be done at least once a month.

5. Washing facilities:

I. In every work place adequate and suitable facilities for washing shall be provided and maintained for the use of Contract labour employed therein.

II. Separate and adequate cleaning facilities shall be provided for the use of male and female workers.

III. Such facilities shall be conveniently accessible and shall be kept in clean and hygienic condition.

6. Latrines and Urinals:

I. Latrines shall be provided in every work place on the following scale, namely:

Where females are employed, there shall be at least one latrine for every 25 females.

Where males are employed, there shall be at least one latrine for every 25 males.

Provided that where the number of males or females exceeds 100, it shall be sufficient if there is one latrine for 25 males or females, as the case may be, up to the first 100, and one for every 50 thereafter.

II. Every latrine shall be under cover and so partitioned off as to secure privacy and shall have a proper door and fastening.

III. Construction of latrines: The inside walls shall be constructed of masonry or some suitable heat resisting, non-absorbent materials and shall be cement washed inside and outside at least once a year. Latrines shall not be of a standard lower than bore-hole system.

Where workers of both sexes are employed, there shall be displayed outside each block of latrine and urinal, a notice in the language understood by the majority of the workers "For Men only" or "For Women only" as the case may be.

The notice shall also bear the figure of a man or of a woman, as the case may be.

IV. There shall be at least one urinal for male workers up to 50 and one for female workers up to 50 employed at a time. Provided that where the number of male or female workmen, as the case may be, exceeds 500, it shall be sufficient if there is one urinal for every 50 males or females up to the first 500 and one for every 100 or part thereof, thereafter.

The latrines and urinals shall be adequately lighted and shall be maintained in a clean and sanitary condition at all times.

Latrines and urinals other than those connected with a flush sewerage system shall comply with the requirements of the Public Health Authorities.

V. Water shall be provided by means of a tap or otherwise so as to be conveniently accessible in or near the latrines and urinals.

VI. Disposal of excreta: Unless otherwise arranged for by the local sanitary authority, arrangements for proper disposal of excreta by incineration at the work place shall be made by means of a suitable incinerator. Alternately excreta may be disposed of by putting a layer of night soil at the bottom of a pucca tank prepared for the purpose and covering it with a 15 cm. layer of waste or refuse and then covering it with a layer of earth for a fortnight (when it will turn into manure).

VII. The Contractor shall, at his own expense, carry out all instructions issued to him by the Engineer-in-Charge to effect proper disposal of night soil and other conservancy work in respect of the Contractor's workmen or employees on the site. The Contractor shall be responsible for payment of any charges which may be levied by Municipal or Cantonment Authority for execution of such work on his behalf.

7. Provision of shelter during rest

At every place there shall be provided, free of cost, four suitable sheds, two for meals, and the other two for rest separately for the use of men and women labour. The height of each shelter shall not be less than 3 metres from the floor level to the lowest part of the roof. These shall be kept clean and the space provided shall be on the basis of 0.6 Sq.m.per head.

8. Creches:

I. At every workplace at which 20 or more women workers are ordinarily employed, there shall be provided two rooms of reasonable dimensions for the use of their children under the age of six years. One room shall be used as a playroom for the children and the other as their bedroom. The rooms shall be constructed with specifications.

II. The rooms shall be provided with suitable and sufficient openings for light and ventilation. There shall be adequate provision of sweepers to keep the places clean.

III. The Contractor shall supply an adequate number of toys and games in the playrooms, and a sufficient number of cots and beddings in the bedroom.

IV. Creche when the number of women workers does not exceed 50, and two Dais when the number of women workers exceeds 50.

V. The use of rooms marked as crèches shall be restricted to children, their attendants, and mothers of the children.

9. **Anti-Malarial Precautions:** The Contractor shall at his own expense conform to all anti-malarial instructions given to him by the Engineer-in-Charge including filling up of any borrow pits which may have been dug by him.
10. **Amendments:** Employer may from time to time add to or amend these rules and issue directions that may consider necessary for removing any difficulty which may arise in the administration thereof.

SECTION-IX
CONTRACTOR'S LABOUR REGULATIONS

SECTION - IX CONTRACTOR'S LABOUR REGULATIONS

1. **Short Title:** These regulations may be called as Project Labour Regulations.

2. Definitions:

(i) "Fair Wages" means wages, whether for time or piece work, fixed and notified under the provisions of the Minimum Wages Act from time to time.

(ii) "Contractors" shall include every person who undertakes to produce a given result other than an sale of goods or articles of manufacture through Contract labour or whose supplies Contract labour for any work and includes as sub-Contractor.

(iii) "Wages" shall have the same meaning as defined in the Payment of Wages Act.3.

Working hours

(i) Normally working hours of an adult employee should not exceed 9 hours a day. The working day shall be so arranged that inclusive of interval for rest, if any, it shall not spread over more than 12 hours on any day.

(ii) When an adult worker is made to work for more than 9 hours on any day or for more than 48 hours in any week, he shall be paid over time for the extra hours put in by him at double the ordinary rate of wages.

(iii)

a. Every worker shall be given a weekly holiday normally on a Sunday, in accordance with the provisions of the Minimum Wages (Central) Rules, 1960 as amended from time to time irrespective of whether such worker is governed by the Minimum Wages Act or not.

b. Where the Minimum Wages prescribed by the Government under the Minimum Wages Act are not inclusive of the wages for the weekly day of rest, the worker shall be entitled to rest day wages at the rate applicable to the next preceding day, provided he has worked under the same Contractor for a continuous period of not less than 6 days.

c. Where a Contractor is permitted by the Engineer-in-Charge to allow a worker to work on a normal weekly holiday, he shall grant a substituted holiday to him for the whole day on one of the five days immediately before or after the normal weekly holiday and pay wages to such worker for the work performed on the normal weekly holiday at over time rate.

4. Display of Notice regarding wages etc.:

The Contractor shall before he commences his work on Contract, display and correctly maintain and continue to display and correctly maintain in a clear and legible condition in conspicuous places on the works, notices in English and in the local Indian languages spoken by the majority of the workers, giving the minimum rates of wages fixed under the Minimum Wages Act, the actual wages being paid, hours of work for which such wages are earned, wage periods, dates of payment of wages and other relevant information as per Appendix - III.

5. Payment of Wages;

- I. The Contractor shall fix wage periods in respect of which wages shall be payable.
- II. No wage period shall exceed one month.
- III. The wages of every person employed as Contract labour in an establishment or by a Contractor where less than one thousand, such persons are employed shall be paid before the expiry of the seventh day and in other cases before the expiry of tenth day after the last day of the wage period in respect of which the wages are payable.
- IV. Where the employment of any worker is terminated by or on behalf of the Contractor, the wages earned by him shall be paid before the expiry of the second working day from the date on which his employment is terminated.
- V. All payments of wages shall be made on a working day at the work premises and during the working time and on a date notified in advance and in case the work is completed before the expiry of the wage period, final payment shall be made within 48 hours of the last working day.
- VI. Wages due to every worker shall be paid to him direct or to other person authorised by him in this behalf.
- VII. Wages shall be paid without any deductions of any kind except those specified by the Central Government by general or special order in this behalf or permissible under the payment of Wages Act, 1956.
- VIII. A notice showing the wages period and the place and time of disbursement of wages shall be displayed at the place of work and a copy sent by the Contractor to the Engineer-in-Charge under acknowledgement.
- IX. It shall be the duty of the Contractor to ensure the disbursement of wages in the presence of the Engineer-in-Charge or any other authorised representative of the Engineer-in-Charge who will be required to be present at the place and time of disbursement of wages by the Contractor to workmen.
- X. The Contractor shall obtain from the Engineer -in-Charge or any other authorised representative of the Engineer-in-Charge as the case may be, a certificate under his signature at the end of the entries in the "Register of wages" or the "Wage-cum-Muster Roll" as the case may be in the following form:
 "Certified that the amount shown in column No.....has been paid to the workman concerned in my presence on.....at....."

6. FINES AND DEDUCTIONS WHICH MAY BE MADE FROM WAGES:

- I. The wages of a worker shall be paid to him without any deductions of any kind except the following:
Fines
- II. Deductions for absence from duty, i.e., from the place or places where by the terms of his employment he is required to work. The amount of deduction shall be in proportion to the period for which he was absent. Deduction for damage to or loss of goods expressly entrusted to the employed person for custody, or for loss of money or any other deduction which he is required to account, where such damage or loss is directly attributable to his neglect or default.
- III. Deduction for recovery of advances or for adjustment of over-payment of wages;
- IV. Advances granted shall be entered in a register.

- V. Any other deduction which the Central Government may from time to time allow.
- VI. No fines should be imposed on any worker save in respect of such acts and omissions on his part as have been approved of by the Chief Labour Commissioner.
- Note: An approved list of facts and omissions for which fines can be imposed is enclosed at Appendix-XI
- VII. No fine shall be imposed on a worker and no deduction for damage or loss shall be made from his wages until the worker has been given an opportunity of showing cause against such fines or deductions.
- VIII. The total amount of fine which may be imposed in any one wage period on a worker shall not exceed an amount equal to three paise in a rupee of the total wages, payable to him in respect of that wage period.
- IX. No fine imposed on any worker shall be recovered from him by instalment, or after the expiry of sixty days from the date on which it was imposed.
- X. Every fine shall be deemed to have been imposed on the day of the act or omission in respect of which it was imposed.

7. Labour Records:

- I. The Contractor shall maintain a "Register of persons employed" on work under Contract in Form XIII of CL (R&A) Central Rules, 1971 (Appendix-IV).
- II. The Contractor shall maintain a "Muster Roll" register in respect of all workmen employed by him on the works under Contract in Form XVI of CL (R&A) Rules, 1971 (Appendix-V).
- III. The Contractor shall maintain a 'Wage Register' in respect of all workmen employed by him on the works under Contract in Form XVII of CL (R&A) Rules, 1971 (Appendix-VI).
- IV. Register of accidents: The Contractor shall maintain a register of accidents in such form as may be convenient at the work place but the same shall include:
- Full particulars of the labourers with whom accident.
 - Rate of wages.
 - Sex.
 - Age.
 - Nature of accident and cause of accident.
 - Time and date of accident.
 - Date and time when admitted to Hospital.
 - Date of discharge from Hospital.

- Period of treatment and result of treatment
 - Percentage of loss of earning capacity and disability as assessed by Medical Officer
 - Claim required to be paid under workmen's Compensation Act.
 - Date of payment of compensation.
 - Amount paid with details of the person to whom the same was paid.
 - Authority by whom the compensation was assessed.
 - Remarks.
- V. **Register of Fines:** The Contractor shall maintain a "Register of Fines" in the form XII of CL (R&A) Rules, 1971 (Appendix-XII).
- The Contractor should display in good condition and in a conspicuous place of work the approved list of Acts and omissions for which fines can be imposed (Appendix-XI).
- VI. **Register of Deductions:** The Contractor shall maintain a "Register of Deductions for Damage or Loss" in Form XX of CL (R&A) Rules, 1971 (Appendix-XIII).
- VII. **Register of Advances:** The Contractor shall maintain a "Register of Advances" in Form XXII of the CL(R&A) Rules, 1971 (Appendix-XIV).
- VIII. **Register of Overtime:** The Contractor shall maintain a "Register of Overtime" in Form XXIII of the CL (R&A) Rules, 1971 (Appendix-XV).

8. Attendance Card-cum-Wage slips:

- I. The Contractor shall issue an attendance card - cum wages slip to each workman employed by him in the Specimen Format (Appendix-VII).
- II. The card shall be valid for each wage period.
- III. The Contractor shall mark the attendance of each workman on the card twice each day, once at the commencement of the day and again after the rest interval, before he actually starts work.
- IV. The card shall remain in possession of the worker during the wage period under reference.
- V. The Contractor shall complete the wage slip portion on the reverse of the card at least a day prior to the disbursement of wages in respect of the wage period under reference.
- VI. The Contractor shall obtain the signature or thumb impression of the worker on the wage slip at the time of disbursement of wages and retain the card with himself.

9. Employment Card: The Contractor shall issue an Employment Card in Form XIV of the CL (R&A) Central Rules, 1971 to each Worker within three days of the employment of the worker (Appendix-IX).

10. Service Certificate: On termination of employment for any reason whatsoever the Contractor shall issue to the workman whose services have been terminated, a service certificate in form XV of the CL(R&A) Central Rule, 1971 (Appendix-X).

11. Preservation of Labour Records:

All records required to be maintained under Regulations Nos. 6 and 7 shall be preserved in original for a period of three years from the date of last entries made in and shall be made available for inspection by the Engineer-in-Charge or Labour Officer or any other officers authorised by the Department in this behalf.

12. Power of Labour Officers to make Investigations or enquiry:

The Labour Officer or any other person authorised by Central Government on their behalf shall have power to make enquiries with a view to ascertaining and enforcing due and proper, observance of the Fair Wages Clauses and the Provisions of Regulations. He shall investigate into any complaint regarding the default made by the Contractor or Subcontractor in regard to such provision.

13. Report of Labour Officer:

The Labour Officer or other persons authorised as aforesaid shall submit a report of result of his investigation or enquiry to the Engineer-in-Charge concerned, indicating the extent, if any, to which the default has been committed with an note that necessary deductions from the Contractor's bill be made and wages and other dues be paid to the labourers concerned. In case an appeal is made by the Contractor under Clause 13 of the regulations actual payment to labourers will be made by the Engineer-in-Charge after the Chief Engineer has given his decision on such appeal.

The Engineer-in-Charge shall arrange payments to the labour concerned within 45 days from the receipt of report from the Labour Officer or the Chief Engineer as the case maybe.

14. Appeal against the decision of Labour Officer:

Any person aggrieved by the decision and recommendations of The Labour Officer or other persons authorised may appeal against such decision to the Chief Engineer concerned within 30 days from the date of decision, forwarding simultaneously a copy of his appeal to The Engineer-in-Charge concerned but subject to such appeal, the decision of the Officer shall be final and binding upon the Contractor.

15. Prohibition regarding representation through lawyers:

I. A workman shall be entitled to be represented in any investigation or enquiry under these regulations by:

- An officer of a registered trade union of which he is a member.
- An officer of a federation of trade unions to which the trade union referred to in Clause (a) is affiliated

II. Where The Employer is not a member of any registered trade union, by an officer of a registered trade union connected with the industry in which the worker is employed or by any other workman employed.

• An Employer shall be entitled to be represented in any investigation or enquiry under these regulations by

- An officer of an association of employers of which he is a member.
- An officer of a federation of associations of employers to which association referred to in Clause(a) is affiliated.
- Where the Employer is not a member of any association of employers, by an officer of association of Employer, connected with the industry in which The Employer is engaged or by any other Employer, engaged

III. No party shall be entitled to be represented by a legal practitioner in any investigation or enquiry under these regulations.

16. Inspection of Books and slips:

The Contractor shall allow inspection of all prescribed labour records to any of his workers or to his agent at a convenient time and place after due notice is received or to the Labour Officer or any other person, authorised by the Central Government on his behalf.

17. Submission of Returns:

The Contractor shall submit periodical returns as may be specified from time to time.

18. Amendments:

The Central Government may, from time to time, add or amend the regulations and on any question as to the application, interpretation or effect of those regulations the decision of the Engineer-in-Charge concerned in that behalf shall be final.

APPENDIXES

APPENDIX-I

**REGISTER OF MATERNITY BENEFITS
(Clause 19F of the conditions of Contract)**

Name and address of the Contractor(s):-----

Name and location of the work: -----

Name of the employee	Father's/ Husband's Name	Nature of employment	Period of actual employment	Date on which notice of confinement given
1	2	3	4	5

Date of delivery/ miscarriage	Date on which maternity leave commenced and ended			
	In case of Delivery		In case of Mis-carriage	
	Commenced	Ended	Commenced	Ended
6	7	8	9	10

Leave pay paid to the employee				Remarks
In case of delivery		In case of Mis-carriage		
Rate of leave	Amount	Rate of leave	Amount	
11	12	13	14	15

APPENDIX-II

**SPECIMEN FORM OF THE REGISTER, REGARDING MATERNITY BENEFIT
ADMISSIBLE TO THE CONTRACTOR'S LABOUR.**

Name and location of the work:-----

Name and address of the Contractor(s):-----

1.	Name of the woman and her husband's Name :	
2.	Designation :	
3.	Date of appointment :	
4.	Date with months and years in which she is employed :	
5.	Date of discharge/dismissal, if any :	
6.	Date of production of certificates in respect of pregnancy :	
7.	Date on which the woman inform about the expected delivery :	
8.	Date of delivery/Miscarriage/death :	
9.	Date of production of certificate in respect of delivery/ miscarriage :	
10.	Date with the amount of maternity/death benefit paid in advance of expected delivery:	
11.	Date with the amount of subsequent payment of maternity benefit :	
12.	Name of the person nominated by the woman to receive the payment of the maternity benefit after her death.	
13.	If the woman dies, the date of her death, the name of the person to whom maternity benefit amount was paid, the month thereof and the date of payment	
14.	Signature of the Contractor authenticating entries in the register :	
15.	Remarks column for the use of inspecting Officer	

APPENDIX-III

LABOUR BOARD

1.	Name of work:	
2.	Name and address of Contractor:	
3.	Name and address of Division:	
4.	Name and address of Labour Officer:	
5.	Name and address of Labour Enforcement officer:	

Sl.No.	Category	Minimum wage	Actual wage paid	Number present	Remarks

Weekly holiday:	
Wage period:	
Date of payment of wages :	
Working hours:	
Rest interval:	

APPENDIX-IV

**FORM XIII
REGISTER OF WORKMEN EMPLOYED BY CONTRACTOR**

Name and address of the Contractor: -----

Name and address of establishment in/under which Contract is carried on:-----

Name and location of the work: -----

Name and address of Principal Employer:-----

Sl. No.	Name and surname of workmen	Age and Sex	Father's/ husband's Name	Nature of employment /designation	Permanent home address of the workman(Village and Tahsil, Taluka& Dist.)	Local Address	Date of commencement of employment	Signature or thumb impression of the workman	Date of Termination of employment	Reasons for terminations	Remarks
1	2	3	4	5	6	7	8	9	10	11	12

APPENDIX-V
FORM XVI
MUSTER ROLL

Name and address of the Contractor:-----
 Name and address of establishment in/under which Contract is carried on:-----
 Name and location of the work:-----
 Name and address of Principal Employer:-----
 For the month of/fortnight:-----

SlNo.	Name of workmen	Sex	Father's Husband's Name	Dates					Remarks
				5					
1	2	3	4	1	2	3	4	5	6

APPENDIX-VI
FORM XVII
REGISTER OF WAGES

Name and address of the Contractor: -----
 Name and address of establishment in/under which Contract is carried on: -----
 Name and location of the work: -----
 Name and address of Principal Employer:-----
 Wages period: Monthly/Fortnightly: -----

Sl. No.	Name of workmen	Serial No. in the register of workmen	Designation/ Nature of work done	No. of Days worked	Units of work done	Daily rate of wages /Piece rate	Amount of wages earned						Net Amount paid	Signature or thumb impression on of workmen	Initial of Contractor or his representative
							Basic wages	Dearness Allowance	Over-time	Other cash payments (indicate)	Total	Deductions if any (Indicate nature)			
1	2	3	4	5	6	7	8	9	10	11	12	13	14	15	16

APPENDIX-VIII
(Reverse)
FORM XIX WAGESLIP

Name and address of Contractor		
Name and Father's/Husband's name of workman		
Nature and location of work		
For the Week/ Fortnight/ Month ending		
	<i>No. of days worked:</i>	
	No .of units worked in case of piece rate workers:	
	Rate of daily wages/piece rate:	
	Amount of overtime wages of overtime wages :	
	Gross wages payable:	
	Deductions, if any:	
	Net amount of wages paid:	

Initials of the Contractor or his representative

APPENDIX-IX

**FORM XIV
EMPLOYMENT CARD**

Name and address of Contractor		
Name And address of establishment in/under which Contract is carried on		
Name of work and location of work		
Name and address of Principal Employer		
	Name of the workman	
	Sl. No. in the register of workman	
	Name of employment/designation	
	Wage rate(with particulars of unit in case of piecework)	
	Wage period	
	Tenure of employment	
	Remarks	

Signature of Contractor or his representative

APPENDIX-X

**FORM XV
SERVICE CERTIFICATE**

Name and address of Contractor:	
Nature & Location of work	
Name and address of workman	
Age or Date of birth	
Identification marks	
Father's/Husband's Name	
Name and address of establishment in/under which Contract is carried on	
Name and address of Principal Employer:	

Sl. No	Total period for which employed		Nature of work done	Rate of wages (with particulars of Unit in case of piece work)	Remarks
	From	To			
1	2	3	4	5	6

Signature

APPENDIX-XI

LIST OF ACTS ANDOMISSIONSFORWHICH FINESCAN BE IMPOSED

1. In accordance with WAPCOS Limited Rules to be displayed prominently at the site of work in both English and local language.
2. Wilful insubordination or disobedience, whether alone or in combination,
3. Theft, fraud or dishonesty in connection with the Contractor's business or property of WAPCOS Limited.
4. Taking or giving bribes or any illegal gratifications.
5. Habitual late attendance.
6. Drunkenness fighting riotous disorderly or indifferent behavior.
7. Habitual negligence.
8. Smoking near or around the area where combustible or other materials are locked.
9. Habitual indiscipline.
10. Causing damage to work in progress or property of WAPCOS Limited or of the Contractor.
11. Sleeping on duty.
12. Malingering slowing down work.
13. Giving false information regarding name, age, father's name etc.
14. Habitual loss of wage cards supplied by the employer.
15. Unauthorised use of Employer's property for manufacture or making of unauthorised articles at the work place.
16. Bad workmanship in construction and maintenance by skilled workers which is not approved by WAPCOS Limited and for which the Contractor are compelled to undertake rectifications.
17. Making false complaints and/or misleading statements.
18. Engaging on trade within the premises of the establishment.
19. Any unauthorised divulgence of business affairs of the employees.
20. Collection or canvassing for collection of any money with in the premises unless authorised by the Employer.
21. Holding meeting inside the premises without previous sanction from employers.
22. Threatening intimidating any workman or employed during working hours within the premises

APPENDIX-XII

**FORM XII
REGISTER OFFINES**

Name and address of Contractor :	
Name And address of establishment in/under which Contract is carried on:	
Name of work and location of work :	
Name and address of Principal Employer:	

Sl No.	Name of Workmen	Father's/Husband's name	Designation/nature of employment	Act/omission for which fine is imposed	Date of Offence	Whether workmen showed cause against fine	Name of person in whose presence employee's	Wage period and wages payable	Amount offine imposed	Date on which fine realised	Remarks
1	2	3	4	5	6	7	8	9	10	11	12

APPENDIX-XIII

FORM XX

REGISTER OF DEDUCTIONS FOR DAMAGE OR LOSS

Name and address of Contractor :	
Name And address of establishment in/under which Contract is carried on:	
Name of work and location of work :	
Name and address of Principal Employer:	

Sl. No.	Name of Workmen	Father's/Husband's name	Designation/nature of employment	Particulars of damage or loss	Date of damage or loss	Whether workmen showed cause against deduction	Name of person in whose presence employee's explanation was heard	Amount of deduction imposed	No. of Instalments	Date of recovery		Remarks
										FirstInstalment	LastInstalment	
1	2	3	4	5	6	7	8	9	1	11	12	13

APPENDIX-XIV

**FORM XXII
REGISTER OF ADVANCES**

Name and address of Contractor :	
Name And address of establishment in/under which Contract is carried on:	
Name of work and location of work :	
Name and address of Principal Employer:	

Sl No.	Name of Workmen	Father s/Husbands name	Designation/nature of employment	Wage period and wages payable	Date and amount of advance given	Purpose (s) for which advance made	No. of Instalments by which advance to be repaid	Date and amount of each instalment repaid	Date and which last instalment was repaid	Remarks
1	2	3	4	5	6	7	8	9	10	11

APPENDIX-XV

**FORM XXIII
REGISTER OF OVERTIME**

Name and address of Contractor :	
Name And address of establishment in/under which Contract is carried on:	
Name of work and location of work :	
Name and address of Principal Employer:	

SI No.	Name of Workmen	Father's/Husbands name	Sex	Designation/nature of employment	Date on which overtime worked	Total overtime worked or production in case of piece rated work	Normal rate of wages	Overtime rate of wages	Overtime earning	Rate on which overtime paid	Remarks
1	2	3	4	5	6	7	8	9	10	11	12

APPENDIX - XVI

GUARANTEE BOND FOR ANTI-TERMITE TREATMENT

For Guarantee to be executed by Contractors for removal of defects after maintenance period.

This agreement made this day of Two thousand (.....) and between

M/s..... (Herein after called "the Guarantor" of the one part) and the WAPCOS Limited

Whereas this agreement is supplementary to a Contract (here in after called "the Contract") dated-----made between the Guarantor of the one part and the WAPCOS Limited, the other part whereby the Contractor inter-alia undertook to render the buildings and structure completely termite proof.

AND WHEREAS THE GUARANTOR agreed to give a Guarantee to the effect that the said structure will remain termite proof for ten years to be reckoned from the date after the maintenance period prescribed in the Contract expires.

NOW THE GUARANTOR hereby Guarantees that the anti-termite treatment provided by him will render the structures completely termite proof and the minimum life of such anti-termite treatment shall be ten years to be reckoned from the date to be reckoned from the date after the maintenance period prescribed in the Contract expires.

Provided that the guarantor will not be responsible for damages caused due to structural defects of premises/area.

Misuse of premises shall mean any operation which will disturb the chemical barrier like excavation under floors, breaking of walls at G.L. disturbing the treatment already carried out. The decision of the Engineer-In-Charge with regard to cause of damage shall be final. During this period of Guarantee the guarantor shall make all the arrangements to do post-constructional anti-termite treatment in all the buildings in case of any termite issue being found in the building to the satisfaction of the Engineer-In-charge at the Cost of guarantee and shall commence work for sought treatment within seven days from date of calling upon him to rectify defects, by The decision of Engineer-In-Charge failing which work shall be

done by Contractor at Guarantee's cost and risk. The decision of Engineer-In-Charge at the cost payable by Guarantor shall be final and binding.

That if Guarantor fails to execute anti-termite treatment or commits breach hereunder then Guarantor will indemnify the principal and his successors against all loss, damage, cost, expense or otherwise which may be incurred by Department by reason of any default on part of Guarantee in performance and observance this supplementary agreement. As to the amount of Loss and /or Damage and/or Cost incurred by Employer the decision of Engineer-In-Charge will be final and binding on parties.

IN WITNESS WHERE OF these presents have been executed by the Obligor.....and by.....and for and on behalf of the WAPCOS Limited on the day, month and year first above written.

SIGNED sealed and delivered by (OBLIGATOR) in the presence of:

- 1.
- 2.

SIGNED FOR AND ONBEHALF OF THE WAPCOS Limited
BY.....

In the presence of:

- 1.
- 2.

SECTION – X SCHEDULE OF QUANTITIES

Grand Summary

Name of Work: Jagga Ki Bawari, NIA Jaipur

S No	ITEM OF CIVIL WORK	AMOUNT	
1.00	Construction of Amphitheater at Jagga Ki Bawari, NIA Jaipur	Rs.	1,89,95,659
2.00	Construction of Gazebo at NIA, Jagga Ki Bawari, Jaipur	Rs.	41,84,576
3.00	Construction of Watch Tower at NIA, Jagga Ki Bawari, Jaipur	Rs.	1,18,19,450
Total including GST		Rs.	3,49,99,685
Total excluding GST		Rs.	2,96,60,750

ABSTRACT OF COST

Name of work: Construction of Amphitheater at Jagga Ki Bawari, NIA Jaipur

S No	ITEM OF CIVIL WORK	AMOUNT DSR		AMOUNT NON DSR
1.00	Civil	Rs.	80,15,179	37,67,400
2.00	Electrical	Rs.	7,95,085	42,93,084
3.00	Horticulture	Rs.	0	20,74,582
Total		Rs.	88,10,264	1,01,35,066
	Additional GST @ 6.33% on Electrical (DSR E&M 2022) to match the present GST@ 18%		50,329	0
	Total including GST	Rs.	88,60,593	1,01,35,066
	TOTAL	Rs.	1,89,95,659	

ABSTRACT OF COST**NAME OF WORK: CONSTRUCTION OF AMPHITHEATRE, NIA JAIPUR, JAGGA KI BAWRI**

S. No.	ITEM OF CIVIL WORK		AMOUNT	
			DSR	NDSR
1.00	Earth Work	Rs.	1276045	0
2.00	Concrete Work	Rs.	618198	0
3.00	R.C.C. Work	Rs.	2483005	0
4.00	Brick Work	Rs.	1544881	0
5.00	Steel Work	Rs.	150090	0
6.00	Flooring	Rs.	124523	0
7.00	Finishing Work	Rs.	192942	3767400
8.00	Water Proofing Work	Rs.	1625496	0
	Total Amount	Rs.	8015179	3767400
	GRAND TOTAL			11782579

SCHEDULE OF QUANTITIES

NAME OF WORK: CONSTRUCTION OF AMPHITHEATRE, NIA JAIPUR, JAGGA KI BAWRI							
Item No.	DSR 2023	Description of Item	Quantity	Unit	Rate	Amount	
			Building		Rs.	DSR	NDSR
1.00	2.0	EARTH WORK					
1.01	2.28	Surface dressing of the ground including removing vegetation and inequalities not exceeding 15 cm deep and disposal of rubbish, lead up to 50 m and lift up to 1.5 m.					
	2.28.1	All kinds of soil.	550.00	Sqm	34.15	18783	
1.02	2.6	Earth work in excavation by mechanical means (Hydraulic excavator)/manual means over areas (exceeding 30 cm in depth, 1.5 m in width as well as 10 sqm on plan) including getting out and disposal of excavated earth lead upto 50 m and lift upto 1.5 m, as directed by Engineer-in-charge.					
	2.6.1	a) All kinds of soil	1750.00	Cum	177.50	310625	
1.03	2.31	Clearing jungle including uprooting of rank vegetation, grass, brush wood, trees and saplings of girth up to 30 cm measured at a height of 1 m above ground level and removal of rubbish up to a distance of 50 m outside the periphery of the area cleared.	550.00	Sqm	17.60	9680	
1.04	2.25	Filling available excavated earth (excluding rock) in trenches, plinth, sides of foundations etc. in layers not exceeding 20cm in depth, consolidating each deposited layer by ramming and watering, lead up to 50 m and lift upto 1.5 m.	601.00	Cum	196.00	117796	
1.05	1.1.2	Disposal of surplus earth by mechanical transport including loading, unloading for a lead upto 10 Km.	1150.00	Cum	442.48	508852	
1.06	2.27	Supplying and filling in plinth with sand under floors, including watering, ramming, consolidating and dressing complete.	13.00	Cum	2123.75	27609	
1.07	2.34	Supplying chemical emulsion in sealed containers including delivery as specified.					
	2.34.1	Chlorpyrifos/ Lindane emulsifiable concentrate of 20%	243.00	Litre	234.75	57044	
1.08	2.35	Diluting and injecting chemical emulsion for POST-CONSTRUCTIONAL anti-termite treatment (excluding the cost of chemical emulsion) :					
a)	2.35.3	Treatment of soil under existing floors using chemical emulsion @ one litre per hole, 300 mm apart including drilling 12 mm diameter holes and plugging with cement mortar 1 :2 (1 cement : 2 Coarse sand) to match the existing floor:					
	2.35.3.1	With Chlorpyrifos/Lindane E.C. 20% with 1% concentration	436.00	Sqm	310.05	135182	
1.09	2.26	Extra for every additional lift of 1.5 m or part thereof in excavation / banking excavated or stacked materials.					
i)	2.26.1	All kinds of soil.	708.00	Cum	126.80	89774	
1.10	2.25(a)	Excavating, supplying and filling of local earth (including royalty) by mechanical transport upto a lead of 5km also including ramming and watering of the earth in layers not exceeding 20 cm in trenches, plinth, sides of foundation etc. complete.	1.00	Cum	700.50	701	
Total Earth Work :						1276045	0
2.00	4.0	CONCRETE WORK					
2.01	4.1	Providing and laying in position cement concrete of specified grade excluding the cost of centering and shuttering - All work up to plinth level :					
i)	4.1.8	1:4:8 (1 Cement : 4 coarse sand (zone-III) : 8 graded stone aggregate 40 mm nominal size)	88.00	Cum	6812.00	599456	
2.02	4.10	Providing and laying damp-proof course 40mm thick with cement concrete 1:2:4 (1 cement : 2 coarse sand (zone-III) derived from natural sources : 4 graded stone aggregate 12.5mm nominal size derived from natural sources)	20.00	Sqm	410.85	8217	
2.03	4.12	Extra for providing and mixing water proofing material in cement concrete work in doses by weight of cement as per manufacturer's specification.	6.00	Per bag of cement of 50 kg	18.15	109	
2.04	4.13	Providing & applying a coat of residual petroleum bitumen of grade of VG-10 of approved quality using 1.7kg per square metre on damp proof course after cleaning the surface with brushes and finally with apiece of cloth lightly soaked in kerosene oil.	20.00	Sqm	146.15	2923	

2.05	4.17	Making plinth protection 50mm thick of cement concrete 1:3:6 (1 cement : 3 coarse sand (zone - III) : 6 graded stone aggregate 20 mm nominal size) over 75mm thick bed of dry brick ballast 40 mm nominal size, well rammed and consolidated and grouted with fine sand, including necessary excavation, levelling & dressing & finishing the top smooth.	10.00	Sqm	749.30	7493	
		Total Cement Concrete work :				618198	0
3.00	5.0	R.C.C. WORK					
3.01	5.33	Providing and laying in position ready mixed or site batched design mix cement concrete for reinforced cement concrete work; using coarse aggregate and fine aggregate derived from natural sources, Portland Pozzolana / Ordinary Portland /Portland Slag cement, admixtures in recommended proportions as per IS: 9103 to accelerate / retard setting of concrete, to improve durability and workability without impairing strength; including pumping of concrete to site of laying, curing, carriage for all leads; but excluding the cost of centering, shuttering, finishing and reinforcement as per direction of the engineer-in-charge, for the following grades of concrete.: Note: Extra cement up to 10% of the minimum specified cement content in design mix shall be payable separately. In case the cement content in design mix is more than 110% of the specified minimum cement content, the contractor shall have discretion to either re-design the mix or bear the cost of extra cement.					
a)	5.33.1	All works upto Plinth level					
	5.33.1.1	Concrete of M25 grade with minimum cement content of 330 kg/cum	73.00	Cum	9504.75	693847	
3.02	5.33.2	All works above plinth level upto floor V level					
	5.33.2.1	Concrete of M25 grade with minimum cement content of 330 kg /cum	25.00	Cum	9860.40	246510	
3.03	5.22	Steel reinforcement for R.C.C. work including straightening, cutting, bending, placing in position and binding all complete upto plinth level.					
	5.22.6	Thermo-Mechanically Treated bars	9056.00	Kg	107.85	976690	
3.04	5.22A	Steel reinforcement for R.C.C. work including straightening, cutting, bending, placing in position and binding all complete above plinth level.					
	5.22A.6	Thermo-Mechanically Treated bars	3004.00	Kg	107.85	323981	
3.05	5.9	Centering and shuttering including strutting, propping etc. and removal of form for :					
a)	5.9.1	Foundations, footings, bases of columns, etc. for mass concrete	78.00	Sqm	392.15	30588	
b)	5.9.7	Stairs, (excluding landings) except spiral-staircases	1.00	Sqm	764.95	765	
c)	5.9.2	Walls (any thickness) including attached pilasters, buttresses, plinth and string courses etc.	250.00	Sqm	842.50	210625	
		Total R.C.C. Work :				2483005	0
4.00	6.0	BRICK WORK					
4.01	6.1	Brick work with common burnt clay F.P.S. (non modular) bricks of class designation 7.5 in foundation and plinth in:					
	6.1.2	Cement mortar 1:6 (1 cement : 6 coarse sand)	25.00	Cum	7132.25	178306	
4.02	6.4	Brick work with common burnt clay F.P.S. (non modular) bricks of class designation 7.5 in superstructure above plinth level up to floor V level in all shapes and sizes in :					
	6.4.2	Cement mortar 1:6 (1 cement : 6 coarse sand)	5.00	Cum	9105.95	45530	
4.03	7.1	Random rubble masonry with hard stone in foundation and plinth including levelling up with cement concrete 1:6:12 (1 cement: 6 coarse sand : 12 graded stone aggregate 20 mm nominal size) upto plinth level with :					
	7.1.1	Cement mortar 1:6 (1 cement: 6 coarse sand)	168.00	Cum	7311.25	1228290	
4.04	7.2	Random rubble masonry with hard stone in superstructure above plinth level and upto floor five level, including leveling up with cement concrete 1:6:12 (1 cement : 6 coarse sand : 12 graded stone aggregate 20 mm nominal size) at window sills, ceiling level and the like.					
	7.2.1	Cement mortar 1:6 (1 cement: 6 coarse sand)	10.00	Cum	9275.45	92755	
		Total Brick Work :				1544881	0
5.00	10.0	STEEL WORK					

5.01	10.2	Structural steel work riveted, bolted or welded in built up sections, trusses and framed work, including cutting, hoisting, fixing in position and applying a priming coat of approved steel primer all complete.	256.00	Kg	133.70	34227	
5.02	10.16	Steel work in built up tubular (round, square or rectangular hollow tubes etc.) trusses etc., including cutting, hoisting, fixing in position and applying a priming coat of approved steel primer, including welding and bolted with special shaped washers etc. complete.					
	10.16.2	Hot finished welded type tubes	596.00	Kg	194.40	115862	
		Total Steel Work :				150090	0
6.00	11.0	FLOORING					
6.01	11.26	Kota stone slab flooring over 20 mm (average) thick base laid over and jointed with grey cement slurry mixed with pigment to match the shade of the slab, including rubbing and polishing complete with base of cement mortar 1 : 4 (1 cement: 4 coarse sand) :					
	11.26.1	25 mm thick	5.00	Sqm	1948.25	9741	
6.02	11.27	Kota stone slabs 20 mm thick in risers of steps, skirting, dado and pillars laid on 12 mm (average) thick cement mortar 1:3 (1 cement: 3 coarse sand) and jointed with grey cement slurry mixed with pigment to match the shade of the slabs, including rubbing and polishing complete	5.00	Sqm	2354.70	11774	
6.03	16.78	Construction of granular sub-base by providing close graded Material conforming to specifications, mixing in a mechanical mix plant at OMC, carriage of mixed material by tippers to work site, for all leads & lifts, spreading in uniform layers of specified thickness with motor grader on prepared surface and compacting with vibratory power roller to achieve the desired density, complete as per specifications and directions of Engineer-in-Charge.					
	16.78.1	With material conforming to Grade-I (size range 75 mm to 0.075 mm) having CBR Value-30	37.00	Cum	2784	103008	
		Total Flooring Work :				124523	0
7.00	13.00	FINISHING					
7.01	13.4	12 mm cement plaster of mix :					
	13.4.2	1:6 (1 cement : 6 coarse sand)	141.00	Sqm	343.65	48455	
7.02	13.62	Painting with synthetic enamel paint of approved brand and manufacture of required colour to give an even shade :					
	13.62.1	Two or more coats on new work	57.00	Sqm	226.25	12896	
7.03	13.18	Neat cement punning.	141.00	Sqm	79.95	11273	
7.04	MR	Providing and applying Graffiti on wall: Mural on exterior wall with exterior paint on wall, with texture effect and radium color according to design concept. Scaffolding, electricity, water in client's scope	70.00	Sqm	53820		3767400
7.05	23.9	Providing and fixing factory made precast RCC perforated drain covers, having concrete of strength not less than M-25, of size 1000 x 450x50 mm, reinforced with 8 mm dia four nos longitudinal & 9 nos cross sectional T.M.T. hoop bars, including providing 50 mm dia perforations @ 100 to 125 mm c/c, including providing edge binding with M.S. flats of size 50 mm x 1.6 mm complete, all as per direction of Engineer-in-charge.	86.00	each	1399.05	120318	
		Total Finishing Work :				192942	3767400
8.00	22.00	WATER PROOFING					
8.01	22.1	Providing and laying integral cement based treatment for water proofing on horizontal surface at all depth below ground level for under ground structures as directed by Engineer-in-Charge and consisting of : (i) 1st layer of 22 mm to 25 mm thick approved and specified rough stone slab over a 25 mm thick base of cement mortar 1:3 (1 cement : 3 coarse sand) mixed with water proofing compound conforming to IS:2645 in the recommended proportion over the leveling course (leveling course to be paid separately). Joints sealed and grouted with cement slurry mixed with water proofing compound. (ii) 2nd layer of 25 mm thick cement mortar 1:3 (1 cement: 3 coarse sand) mixed with water proofing compound in recommended proportions.					

		(iii) Finishing top with stone aggregate of 10 mm to 12 mm nominal size spreading @ 8 cudm/sqm thoroughly embedded in the 2nd layer.					
a)	22.1.1	Using rough kota stone.	489.00	Sqm	1515.60	741128	
8.02	22.2	Providing and laying integral cement based treatment for water proofing on the vertical surface by fixing specified stone slab 22 mm to 25 mm thick with cement slurry mixed with water proofing compound conforming to IS:2645 in recommended proportions with a gap of 20 mm (minimum) between stone slabs and the receiving surfaces and filling the gaps with neat cement slurry mixed with water proofing compound and finishing the exterior of stone slab with cement mortar 1:3 (1 cement : 3 coarse sand) 20 mm thick with neat cement punning mixed with water proofing compound in recommended proportion complete at all levels and as directed by Engineer-in-charge :					
a)	22.2.1	Using rough kota stone.	364.00	Sqm	2024.7	736991	
8.03	22.26	Providing and applying of swellable type water stop tape, 19mm x 25mm thick in linear meter (expansive nature) for construction joints treatment of RCC structure such as raft slab, retaining walls, water storage tank and at the junctions of raft slab with the retaining walls etc.. After cleaning the surface, one coat of required primer for swellable water stop tape shall be applied throughout the length of the joint @3.78 litre per 240 running meter. Over the primed surface swellable type water stop tape shall be placed. The work shall be carried out all complete as per specification and the direction of the Engineer-In-Charge. The product performance shall carry guarantee for 10 years against any leakage.	257.00	Metre	573.45	147377	
		Total Water Proofing work :				1625496	7534800

SCHDEULE OF QUANTITIES: ELECTRICAL

S.No.	DSR/MR	DESCRIPTION	Unit	QTY	Rate	DSR Amount	Non DSR Amount
1	MR	Supply, Installation, Testing and Commissioning of LED Luminaries of 250W LED Flood Light luminaire with System efficacy of more than 120 lm/W. LED Flood Light shall be made up of Die Cast aluminium housing modules suitable to be cradle mounted. Luminaire shall have LEDs and driver with IP 66 ingress protection. Optical compartment shall be provided with Polycarbonate Lens to withstand IK10 impact rating. LEDs used in the product shall comply with EN 62471 for Photo-biological safety . The LED shall be compliant with LM80-08 standard with Useful L70 life of 50000 Hrs. The LEDs used in Flood Light should be MacAdam Step 5 standard Rated LED with CCT of 5700 K and CRI >70 with 22 degree beam angle. LED Driver should be BIS Registered. Aluminium enclosure with proper heat sink for heat dissipation suitable to operate in input voltage range of 140V to 280V (nominal rated voltage – 240V) with 5KV internal surge protection. Power factor greater than 0.95 and total harmonic distortion (THD) of less than 10% should be integral to the luminaire. Luminaire shall be external SPD of 10KV. Luminaire and Driver shall be of same make to avoid any service issues. Manufacturer shall have in house NABL Lab for LM79 Testing and validation. Dimensions of fixture 310mm X 390mm X 73mm(Tolerance +/-5mm) (Similar to Wipro LF45-342-022-57-GS/ Phillips / Bajaj)	Each	32	22920		733440
2	MR	Supply, Installation, Testing and Commissioning of 7W LED Step Light delivering minimum system lumen of 140 lm .Extruded aluminium housing & PC clear diffuser. The operating CCT shall be 5700K with CRI of ≥80. Luminaire shall be PF ≥= 0.9 and THD =< 15% with Driver Efficiency of >= 75% at rated wattage. The luminaire shall be BIS Registered with electronic driver with input voltage range of 150-280V, IP 66, IK 07, 50000 Hrs LED life with L70 Criteria. The LED driver shall be easily available in India for repair and service. The LED shall be SMD type. The luminaire shall be with following certifications: LM79 & LM80 issued by LED manufacturer along with Photo Biological Safety Standard. Having inbuilt surge protection of 4KV. Dimensions : 128mm X 195mm X 85mm (Tolerance +/- 5mm) (Similar to Wipro LT51-750-XXX-57-GS/ Phillips/ Bajaj)	Each	60	3901		234060
3	MR	Supplying and installation, testing and commissioning of -16Mast Polygonal Pole(suitable to install upto 8 luminaries) . Material conforming to Confirming to BSEN 10025 OR IS 2062, in 02 section of 3mm & 4mm each 8300mm length, with top 7 bottom dia of 150/410mm with stress slip fit Joint, & thickness 16 mm,Base Plate Diameter & Thickness Diameter 570 mm & Thickness 32 mm. (Wipro/ Phillips/ Bajaj)	Each	4	671715		2686860
4	1.10	Wiring for light point/ fan point/ exhaust fan point/ call bell point with 1.5 sq.mm FRLS PVC insulated copper conductor single core cable in surface / recessed medium class PVC conduit, with modular switch, modular plate, suitable GI box and earthing the point with 1.5 sq.mm. FRLS PVC insulated copper conductor single core cable etc as required.					
	1.10.3	Group C	Point	10	1467.00	14670.00	
5	1.55	Wiring for group controlled (looped) light point/ fan point/call bell point (without independent switch etc.) with 1.5 sq.mm FRLS PVC insulated copper conductor single core cable in surface / recessed PVC conduit, and earthing the point with 1.5 sq.mm. FRLS PVC insulated copper conductor single core cable etc as required.					
	1.55.3	Group C	Point	50	858.00	42900.00	
6		CABLES					
	7.1	Laying of one number PVC insulated and PVC sheathed / XLPE power cable of 1.1 KV grade of following size direct in ground including excavation, sand cushioning, protective covering and refilling the trench etc as required.					
	7.1.1	Upto 35 sq. mm	Metre	300	387.00	116100.00	
	7.1.2	Above 35 sq. mm and upto 95 sq. mm	Metre	200	405.00	81000.00	
7.0	9.1	Supplying and making end termination with brass compression gland and aluminium lugs for following size of PVC insulated and PVC sheathed / XLPE aluminium conductor cable of 1.1 KV grade as required.					
	9.1.21	3½ X 35 sq. mm (32mm)	EACH	80	369.00	29520	
	9.1.36	3.5 X 50 sq. mm (35mm)	EACH	16	418.00	6688	
		LT CABLES					
8		Supply and fixing of following XPLE armoured 1.1 KV grade conforming to I.S.7098/1554Aluminium Conductor Cables :					
		Supply of following sizes of PVC sheathed PVC/XLPE insulated Aluminium conductor armoured cable of 1.1 KV grade conforming to IS:7098 part-1 / IS:1554 part-1 respectively & ISI marked.					
a	MR	3.5 C x 35 Sqmm XLPE cable	RM	300	607.00		182100
b	MR	3.5 C x 50 Sqmm XLPE cable	RM	200	822.00		164400
9	MR	External lighting panel					

	Botanical name/ Common name	QTY	UNIT	C\C (mm)	Poly Bag dia mm		Rate (Rs)	Amount (Rs)
	Ground covers							
A	Ophiopogon jaburans	50	sqm.		150		285.00	14250
B	Seasonal bed/ Rhoec discolor	50	sqm.		150		190.00	9500
C	Dianella Varigated	15	sqm.		150		190.00	2850
D	Wadellia trilobata	300	sqm.		150		285.00	85500
	TOTAL	415	sqm.					112100
5	Manure and Sweet Earth							
5.1	Manure for Ground Floor Areas							
	Supplying and stacking cow dung manure at site including royalty and carriage (manure measured in stacks will be reduced by 8% for payment). The project labour cost to supply & stack dump at various level of ground as per site requirement.			1	cum		342.00	342.00
5.2	Sweet earth for Ground Floor							
	Supplying and stacking sweet earth including royalty and carriage (sweet earth measured in stacks will be deducted by 20% for payment) for mounds specified level mention in drawing and other areas as per site condition			1	cum		266.00	266.00
	GRAND TOTAL							2074582.00

ABSTRACT OF COST

Name of work: Construction of Gazebo at NIA, Jagga Ki Bawari, Jaipur

S No	ITEM OF CIVIL WORK	AMOUNT DSR		AMOUNT NON DSR
1.00	Civil	Rs.	33,76,079	0
2.00	Electrical	Rs.	3,30,872	4,56,680
Total		Rs.	37,06,951	4,56,680
	Additional GST @ 6.33% on DSR Item to match the present GST@ 18%		20,944	0
	Total including GST	Rs.	37,27,896	4,56,680
	TOTAL COST OF 4 GAZEBO	Rs.	41,84,576	

ABSTRACT OF COST

NAME OF WORK : CONSTRUCTION OF CAST IRON HEXAGONAL GAZEBO, NIA JAIPUR, JAGGA KI BAWARI

S. No.	ITEM OF CIVIL WORK	AMOUNT			
			DSR	MR	
1.00	Earth Work	Rs.	50689	0	/-
2.00	Concrete Work	Rs.	132166	0	/-
3.00	R.C.C. Work	Rs.	514335	0	/-
4.00	Brick Work	Rs.	57058	0	/-
5.00	Steel Work	Rs.	76174	0	/-
6.00	Flooring	Rs.	237632	0	/-
7.00	Finishing	Rs.	1810	2306216	/-
Total Amount		Rs.	1069863	2306216	/-
GRAND TOTAL			3376079		

SCHEDULE OF QUANTITIES

NAME OF WORK : CONSTRUCTION OF CAST IRON HEXAGONAL GAZEBO, NIA JAIPUR, JAGGA KI BAWARI

Item No.	DSR 2023	Description of Item	Quantity		Rate Rs.	Amount	
			Building	Unit		DSR	MR
1.00	2.0	<u>EARTH WORK</u>					
1.01	2.28	Surface dressing of the ground including removing vegetation and inequalities not exceeding 15 cm deep and disposal of rubbish, lead up to 50 m and lift up to 1.5 m.					
	2.28.1	All kinds of soil.	60.00	Sqm	34.15	2049	/-
1.02	2.6	Earth work in excavation by mechanical means (Hydraulic excavator)/manual means over areas (exceeding 30 cm in depth, 1.5 m in width as well as 10 sqm on plan) including getting out and disposal of excavated earth lead upto 50 m and lift upto 1.5 m, as directed by Engineer-in-charge.					
	2.6.1	a) All kinds of soil	80.00	Cum	177.50	14200	/-
1.03	2.25	Filling available excavated earth (excluding rock) in trenches, plinth, sides of foundations etc. in layers not exceeding 20cm in depth, consolidating each deposited layer by ramming and watering, lead up to 50 m and lift upto 1.5 m.	80.00	Cum	196.00	15680	/-
1.04	1.1.2	Carriage of earth by mechanical transport including loading, unloading for a lead upto 10 Km.	4.00	Cum	442.48	1770	/-
1.05	2.27	Supplying and filling in plinth with sand under floors, including watering, ramming, consolidating and dressing complete.	8.00	Cum	2123.75	16990	/-
		Total Earth Work :				50689	
2.00	4.0	<u>CONCRETE WORK</u>					
2.01	4.1	Providing and laying in position cement concrete of specified grade excluding the cost of centering and shuttering - All work up to plinth level :					
i)	4.1.8	1:4:8 (1 Cement : 4 coarse sand (zone-III) : 8 graded stone aggregate 40 mm nominal size)		Cum	6812.00	0	
ii)	4.1.10	1:5:10 (1 cement: 5 coarse sand (zone-III) derived from natural sources : 10 graded stone aggregate 40 mm nominal size derived from natural sources)	12.00	Cum	6518.60	78223	/-
2.02	4.10	Providing and laying damp-proof course 40mm thick with cement concrete 1:2:4 (1 cement : 2 coarse sand (zone-III) derived from natural sources : 4 graded stone aggregate 12.5mm nominal size derived from natural sources)	16.00	Sqm	410.85	6574	/-
2.03	4.12	Extra for providing and mixing water proofing material in cement concrete work in doses by weight of cement as per manufacturer's specification.	4.00	Per bag of cement of 50 kg	18.15	73	/-
2.04	4.13	Providing & applying a coat of residual petroleum bitumen of grade of VG-10 of approved quality using 1.7kg per square metre on damp proof course after cleaning the surface with brushes and finally with apiece of cloth lightly soaked in kerosene oil.	16.00	Sqm	146.15	2338	/-
2.05	4.17	Making plinth protection 50mm thick of cement concrete 1:3:6 (1 cement : 3 coarse sand (zone - III) : 6 graded stone aggregate 20 mm nominal size) over 75mm thick bed of dry brick ballast 40 mm nominal size, well rammed and consolidated and grouted with fine sand, including necessary excavation, levelling & dressing & finishing the top smooth.	60.00	Sqm	749.30	44958	/-
		Total Cement Concrete work :				132166	
3.00	5.0	<u>R.C.C. WORK</u>					
3.01	5.33	Providing and laying in position ready mixed or site batched design mix cement concrete for reinforced cement concrete work; using coarse aggregate and fine aggregate derived from natural sources, Portland Pozzolana / Ordinary Portland /Portland Slag cement, admixtures in recommended proportions as per IS: 9103 to accelerate / retard setting of concrete, to improve durability and workability without impairing strength; including pumping of concrete to site of laying, curing, carriage for all leads; but excluding the cost of centering, shuttering, finishing and reinforcement as per direction of the engineer-in-charge, for the following grades of concrete.:					

		Note: Extra cement up to 10% of the minimum specified cement content in design mix shall be payable separately. In case the cement content in design mix is more than 110% of the specified minimum cement content, the contractor shall have discretion to either re-design the mix or bear the cost of extra cement.						
a)	5.33.1	All works upto Plinth level						
	5.33.1.1	Concrete of M25 grade with minimum cement content of 330 kg /cum	16.00	Cum	9504.75	152076		/-
3.02	5.33.2	All works above plinth level upto floor V level						
	5.33.2.1	Concrete of M25 grade with minimum cement content of 330 kg /cum	4.00	Cum	9860.40	39442		/-
3.03	5.22	Steel reinforcement for R.C.C. work including straightening, cutting, bending, placing in position and binding all complete upto plinth level.						
	5.22.6	Thermo-Mechanically Treated bars	1648.00	Kg	107.85	177737		/-
3.04	5.22A	Steel reinforcement for R.C.C. work including straightening, cutting, bending, placing in position and binding all complete above plinth level.						
	5.22A.6	Thermo-Mechanically Treated bars	440.00	Kg	107.85	47454		/-
3.05	5.9	Centering and shuttering including strutting, propping etc. and removal of form for :						
a)	5.9.1	Foundations, footings, bases of columns, etc. for mass concrete	24.00	Sqm	392.15	9412		/-
c)	5.9.5	Lintels, beams, plinth beams, girders, bressumers and cantilevers	56.00	Sqm	736.40	41238		/-
f)	5.9.6	Columns, Pillars, Piers, Abutments, Posts and Struts	48.00	Sqm	961.30	46142		/-
i)	5.9.16	Edges of slabs and breaks in floors and walls						
	5.9.16.1	Under 20 cm wide	4.00	metre	208.55	834		/-
		Total R.C.C. Work :				514335		
4.00	6.0	BRICK WORK						
4.01	6.1	Brick work with common burnt clay F.P.S. (non modular) bricks of class designation 7.5 in foundation and plinth in:						
	6.1.2	Cement mortar 1:6 (1 cement : 6 coarse sand)	8.00	Cum	7132.25	57058		/-
		Total Brick Work :				57058		
5.00	10.0	STEEL WORK						
5.01	10.2	Structural steel work riveted, bolted or welded in built up sections, trusses and framed work, including cutting, hoisting, fixing in position and applying a priming coat of approved steel primer all complete.	508.00	Kg	133.70	67920		/-
5.02	10.16	Steel work in built up tubular (round, square or rectangular hollow tubes etc.) trusses etc., including cutting, hoisting, fixing in position and applying a priming coat of approved steel primer, including welding and bolted with special shaped washers etc. complete.						
	10.16.2	Hot finished seamless type tubes	40.00	Kg	206.35	8254		/-
		Total Steel Work :				76174		
6.00	11.0	FLOORING						
6.01	16.75	Providing and laying C.C. pavement of mix M-25 with ready mixed concrete from batching plant. The ready mixed concrete shall be laid and finished with screed board vibrator , vacuum dewatering process and finally finished by floating, brooming with wire brush etc. complete as per specifications and directions of Engineer-in-charge. (The panel shuttering work shall be paid for separately).(Note:- Cement content considered in this item is @ 330 kg/cum. Excess/ less cement used as per design mix is payable/ recoverable separately).	8.00	Cum	9823.80	78590		/-
6.02	11.56	Providing and laying Polished Granite stone flooring in required design and patterns, in linear as well as curvilinear portions of the building all complete as per the architectural drawings with 18 mm thick stone slab over 20 mm (average) thick base of cement mortar 1:4 (1 cement : 4 coarse sand) laid and jointed with cement slurry and pointing with white cement slurry admixed with pigment of matching shade including rubbing ,curing and polishing etc. all complete as specified and as directed by the Engineer-in-Charge.						

	11.56.1	Polished Granite stone slab of colour Black, Cherry/Ruby Red or equivalent	12.00	Sqm	4481.30	53776		/-
6.03	Analysis of DSR	Granite stone slab 18 mm thick in risers of steps, skirting, and Cladding laid on 12 mm (average) thick cement mortar 1:3 (1 cement : 3 coarse sand) and jointed with grey cement slurry mixed with pigment to match the shade of the slab, including rubbing and polishing complete.	8.00	Sqm	8641.00	69128		/-
6.04	11.24	Extra for pre finished nosing to treads of steps of marble stone.	36.00	metre	719.90	25916		/-
6.05	11.25	Extra for marble stone flooring in treads of steps and risers using single length up to 2.00 metre.	12.00	Sqm	851.80	10222		/-
		Total Flooring Work :				237632		
7.00	13.0	FINISHING						
7.01	13.62	Painting with synthetic enamel paint of approved brand and manufacture of required colour to give an even shade :						
	13.62.1	Two or more coats on new work	8.00	Sqm	226.25	1810		/-
7.02	MR	Providing and fixing Cast iron hexagonal on side open Gazebo size 12'x12' as per drawing and direction engineer-in-charge	4.00	each	576554.00		2306216	/-
		Total Finishing Work :				1810	2306216	

S.No.	DSR/MR	DESCRIPTION	Unit	QTY.	Rate	DSR Amount	Non DSR Amount
1	MR	Supply, Installation, Testing and Commissioning of Recessed/ Surface Mounted downlight with HPE (High-Performance Efficiency) with LED (Light Emitting Diode), system power: 12 W, Luminous flux of luminaire 1320 lm, 110 LM/W system efficacy, Colour temperature of 4000 K, Neutral white, CRI > 80, 230V constant current driver, 70% of luminous flux after 50,000 operating hours; energy-efficient LEDs, direct light emission, housing in die-cast aluminium, Polyester powder white coloured coat applied over a 5-stage pre-treatment trim, prismatic diffuser for homogenous light distribution, ZHLS (ZERO HALOGEN LOW SMOKE) wiring, Electronic control gear, Protection class II, IP 40, Ø = 175 mm, DA(Ø) = 160 mm, H = 59 mm	no	24	1395.00		33480.00
2	19.1	Supply, Installation, Testing and Commissioning of 1200 mm sweep, BEE 5 star rated, ceiling fan with Brush Less Direct Current (BLDC) Motor, class of insulation: B, 3 nos. blades, 30 cm long down rod, 2 nos. canopies, shackle kit, safety rope, copper winding, Power Factor not less than 0.9, Service Value (CMM/W) minimum 6.85, Air delivery minimum 215 CMM, 350 RPM (tolerance as per IS : 374- 2019), THD less than 10%, remote or electronic regulator unit for speed control and all remaining accessories including safety pin, nut bolts, washers, temperature rise=75 degree C (max.), insulation resistance more than 2 mega ohm, suitable for 230 V, 50 Hz, single phase AC Supply, earthing etc. complete as required.	Each	4	2730.00	10920.00	
3	1.45	Installation, testing and commissioning of ceiling fan including wiring the down rods of standard length (upto 30 cm) with 1.5 sq. mm FR PVC insulated, copper conductor, single core cable including providing and fixing phenolic sheet cover on the fan box as required etc	Nos.	4	339.00	1356.00	
4	1.10	Wiring for light point/ fan point/ exhaust fan point/ call bell point with 1.5 sq.mm FRLS PVC insulated copper conductor single core cable in surface / recessed medium class PVC conduit, with modular switch, modular plate, suitable GI box and earthing the point with 1.5 sq.mm. FRLS PVC insulated copper conductor single core cable etc as required.		0			
	1.10.3	Group C	Point	12	1467.00	17604.00	
5	1.55	Wiring for group controlled (looped) light point/ fan point/call bell point (without independent switch etc.) with 1.5 sq.mm FRLS PVC insulated copper conductor single core cable in surface / recessed PVC conduit, and earthing the point with 1.5 sq.mm. FRLS PVC insulated copper conductor single core cable etc as required.		0			
	1.55.3	Group C	Point	16	858.00	13728.00	
6		CABLES		0			
	7.1	Laying of one number PVC insulated and PVC sheathed / XLPE power cable of 1.1 KV grade of following size direct in ground including excavation, sand cushioning, protective covering and refilling the trench etc as required.		0			
	7.1.1	Upto 35 sq. mm	Metre	400	387.00	154800.00	
7.0	9.1	Supplying and making end termination with brass compression gland and aluminium lugs for following size of PVC insulated and PVC sheathed / XLPE aluminium conductor cable of 1.1 KV grade as required.		0			
	9.1.33	4 X 16 sq. mm (28mm)	EACH	32	309.00	9888	
		LT CABLES		0			
8		Supply and fixing of following XPLE armoured 1.1 KV grade conforming to I.S.7098/1554 Aluminium Conductor Cables :		0			
		Supply of following sizes of PVC sheathed PVC/XLPE insulated Aluminium conductor armoured cable of 1.1 KV grade conforming to IS:7098 part-1 / IS:1554 part-1 respectively & ISI marked.		0			
a	MR	4 C x 16 Sqmm XLPE cable	RM	400	408.00		163200
9	MR	External lighting panel		0			

ABSTRACT OF COST

Name of work: Construction of Watch Tower at NIA, Jagga Ki Bawari, Jaipur

S No	ITEM OF CIVIL WORK	AMOUNT DSR		AMOUNT NON DSR
1.00	Civil	Rs.	1,01,66,733	0
2.00	Electrical	Rs.	7,47,752	8,57,632
Total		Rs.	1,09,14,485	8,57,632
	Additional GST @ 6.33% on DSR Item to match the present GST@ 18%		47,333	0
	Total including GST	Rs.	1,09,61,818	8,57,632
	TOTAL COST OF 4 WATCH TOWER	Rs.	1,18,19,450	

ABSTRACT OF COST

NAME OF WORK : CONSTRUCTION OF WATCH TOWER, NIA JAIPUR, JAGGA KI BAWARI

S. No.	ITEM OF CIVIL WORK	AMOUNT			
			DSR	NDSR	
1.00	Earth Work	Rs.	181973	0	/-
2.00	Concrete Work	Rs.	174027	0	/-
3.00	R.C.C. Work	Rs.	5347048	0	/-
4.00	Brick Work	Rs.	255417	0	/-
5.00	Flooring Work	Rs.	375954	3632479	/-
6.00	Finishing	Rs.	199835	0	/-
Total Amount		Rs.	6534254	3632479	/-
GRAND TOTAL			10166733		

SCHEDULE OF QUANTITIES

NAME OF WORK : CONSTRUCTION OF WATCH TOWER, NIA JAIPUR, JAGGA KI BAWARI

Item No.	DSR 2023	Description of Item	Quantity Building	Unit	Rate	Amount	
					Rs.	DSR	NDSR
1.00	2.0	EARTH WORK					
1.01	2.28	Surface dressing of the ground including removing vegetation and inequalities not exceeding 15 cm deep and disposal of rubbish, lead up to 50 m and lift up to 1.5 m.					
1.02	2.6	Earth work in excavation by mechanical means (Hydraulic excavator)/manual means over areas (exceeding 30 cm in depth, 1.5 m in width as well as 10 sqm on plan) including getting out and disposal of excavated earth lead upto 50 m and lift upto 1.5 m, as directed by Engineer-in-charge.					
1.03	2.25	Filling available excavated earth (excluding rock) in trenches, plinth, sides of foundations etc. in layers not exceeding 20cm in depth, consolidating each deposited layer by ramming and watering, lead up to 50 m and lift upto 1.5 m.	227.68	Cum	196.00	44625	/-
1.04	1.1.2	Carriage of earth by mechanical transport including loading, unloading for a lead upto 10 Km.	33.43	Cum	442.48	14791	/-
1.05	2.27	Supplying and filling in plinth with sand under floors, including watering, ramming, consolidating and dressing complete.	8.15	Cum	2123.75	17312	/-
1.06	2.34	Supplying chemical emulsion in sealed containers including delivery as specified.					
1.07	2.35	Diluting and injecting chemical emulsion for POSTCONSTRUCTIONAL anti-termite treatment (excluding the cost of chemical emulsion) :					
a)	2.35.3	Treatment of soil under existing floors using chemical emulsion @ one litre per hole, 300 mm apart including drilling 12 mm diameter holes and plugging with cement mortar 1 :2 (1 cement : 2 Coarse sand) to match the existing floor:					
1.08	2.26	Extra for every additional lift of 1.5 m or part thereof in excavation / banking excavated or stacked materials.					
i)	2.26.1	All kinds of soil.	97.02	Cum	126.80	12302	/-
1.09	2.25(a)	Excavating, supplying and filling of local earth (including royalty) by mechanical transport upto a lead of 5km also including ramming and watering of the earth in layers not exceeding 20 cm in trenches, plinth, sides of foundation etc. complete.	4.00	Cum	700.50	2802	/-
2.00	4.0	CONCRETE WORK					
2.01	4.1	Providing and laying in position cement concrete of specified grade excluding the cost of centering and shuttering - All work up to plinth level :					
i)	4.1.8	1:4:8 (1 Cement : 4 coarse sand (zone-III) : 8 graded stone aggregate 40 mm nominal size)	15.98	Cum	6812.00	108847	
2.03	4.10	Providing and laying damp-proof course 40mm thick with cement concrete 1:2:4 (1 cement : 2 coarse sand (zone-III) derived from natural sources : 4 graded stone aggregate 12.5mm nominal size derived from natural sources)	7.72	Sqm	410.85	3172	/-
2.04	4.12	Extra for providing and mixing water proofing material in cement concrete work in doses by weight of cement as per manufacturer's specification.	2.01	Per bag of cement of 50 kg	18.15	36	/-
2.05	4.13	Providing & applying a coat of residual petroleum bitumen of grade of VG-10 of approved quality using 1.7kg per square metre on damp proof course after cleaning the surface with brushes and finally with apiece of cloth lightly soaked in kerosene oil.	7.72	Sqm	146.15	1128	/-
2.06	4.17	Making plinth protection 50mm thick of cement concrete 1:3:6 (1 cement : 3 coarse sand (zone - III) : 6 graded stone aggregate 20 mm nominal size) over 75mm thick bed of dry brick ballast 40 mm nominal size, well rammed and consolidated and grouted with fine sand, including necessary excavation, levelling & dressing & finishing the top smooth.	81.20	Sqm	749.30	60843	/-
3.00	5.0	R.C.C. WORK					

3.01	5.33	Providing and laying in position ready mixed or site batched design mix cement concrete for reinforced cement concrete work; using coarse aggregate and fine aggregate derived from natural sources, Portland Pozzolana / Ordinary Portland /Portland Slag cement, admixtures in recommended proportions as per IS: 9103 to accelerate / retard setting of concrete, to improve durability and workability without impairing strength; including pumping of concrete to site of laying, curing, carriage for all leads; but excluding the cost of centering, shuttering, finishing and reinforcement as per direction of the engineer-in-charge, for the following grades of concrete.:						
a)	5.33.1	All works upto Plinth level						
3.02	5.33.2	All works above plinth level upto floor V level						
3.03	5.22	Steel reinforcement for R.C.C. work including straightening, cutting, bending, placing in position and binding all complete upto plinth level.						
3.04	5.22A	Steel reinforcement for R.C.C. work including straightening, cutting, bending, placing in position and binding all complete above plinth level.						
3.05	5.9	Centering and shuttering including strutting, propping etc. and removal of form for :						
a)	5.9.1	Foundations, footings, bases of columns, etc. for mass concrete	28.68	Sqm	392.15	11247		/-
b)	5.9.3	Suspended floors, roofs, landings, balconies and access platform	269.84	Sqm	927.25	250209		/-
c)	5.9.5	Lintels, beams, plinth beams, girders, bressumers and cantilevers	370.17	Sqm	736.40	272591		/-
d)	5.9.19	Weather shade, Chajjas, corbels etc., including edges	4.00	Sqm	951.10	3804		/-
e)	5.9.7	Stairs, (excluding landings) except spiral-staircases	73.84	Sqm	764.95	56484		/-
f)	5.9.6	Columns, Pillars, Piers, Abutments, Posts and Struts	422.78	Sqm	961.30	406422		/-
g)	5.9.4	Shelves (Cast in situ)	4.00	Sqm	927.25	3709		/-
h)	5.9.15	Small lintels not exceeding 1.5 m clear span, moulding as in cornices, window sills, string courses, bands, copings, bed plates, anchor blocks and the like	4.00	Sqm	392.15	1569		/-
i)	5.9.16	Edges of slabs and breaks in floors and walls						
j)	5.9.14	Extra for shuttering in circular work (20% of respective centering and shuttering items)	4.00	Sqm	192.26	769		/-
k)	5.9.2	Walls (any thickness) including attached pilasters, buttersesses, plinth and string courses etc.	3.56	Sqm	842.50	2999		/-
3.06	5.30	Add for plaster drip course/ groove in plastered surface or moulding to R.C.C. projections.	4.00	metre	78.40	314		/-
3.07	5.11	Extra for additional height in centering, shuttering where ever required with adequate bracing, propping etc., including cost of de-shuttering and decentering at all levels, over a height of 3.5 m, for every additional height of 1 metre or part thereof (Plan area to be measured).						
4.00	6.0	<u>BRICK WORK</u>						
4.01	6.1	Brick work with common burnt clay F.P.S. (non modular) bricks of class designation 7.5 in foundation and plinth in:						
4.02	6.4	Brick work with common burnt clay F.P.S. (non modular) bricks of class designation 7.5 in superstructure above plinth level up to floor V level in all shapes and sizes in :						
4.03	6.12	Half brick masonry with common burnt clay F.P.S. (non modular) bricks of class designation 7.5 in foundations and plinth in :						
4.04	6.13	Half brick masonry with common burnt clay F.P.S. (non modular) bricks of class designation 7.5 in superstructure above plinth level up to floor V level						
4.05	6.15	Extra for providing and placing in position 2 Nos 6mm dia. M.S. bars at every third course of half brick masonry.	40.00	Sqm	104.80	4192		/-
5.00	8.0	<u>FLOORING WORK</u>						

5.01	8.2	Providing and fixing 18 mm thick gang saw cut, mirror polished, premoulded and prepolished, machine cut for kitchen platforms, vanity counters, window sills, facias and similar locations of required size, approved shade, colour and texture laid over 20 mm thick base cement mortar 1:4 (1 cement : 4 coarse sand), joints treated with white cement, mixed with matching pigment, epoxy touch ups, including rubbing, curing, edge moulding and polishing to edges to give high gloss finish etc. complete at all levels.						
5.02	8.5	Extra for providing opening of required size & shape for wash basin/ kitchen sink in kitchen platform, vanity counter and similar location in marble/ Granite/ stone work, including necessary holes for pillar taps etc. including moulding, rubbing and polishing of cut edges etc. complete.	4.00	Each	978.70	3915		/-
5.03	MR	Providing and fixing GRC Moulding	84.96	metre	5857.00		497611	/-
5.04	MR	Providing and fixing GRC Balusters	1452.00	each	1570.00		2279640	/-
5.05	MR	Providing and fixing Wooden eaves board (Jhallar)	105.60	metre	2877.00		303811	/-
5.06	MR	Providing and fixing Clay tiles roof covering on R.C.C. frame work (as per structural details), brick red colour to be fixed with	191.66	Sqm	2877.00		551417	/-
5.07	11.41	Providing and laying vitrified floor tiles in different sizes (thickness to be specified by the manufacturer) with water absorption less than 0.08% and conforming to IS: 15622, of approved make, in all colours and shades, laid on 20mm thick cement mortar 1:4 (1 cement : 4 coarse sand), jointing with grey cement slurry @ 3.3 kg/ sqm including grouting the joints with white cement and matching pigments etc., complete.						
5.08	11.46	Providing and laying Vitrified tiles in different sizes (thickness to be specified by manufacturer), with water absorption less than 0.08 % and conforming to I.S. 15622, of approved make, in all colours & shade, in skirting, dado, riser of steps, over 12 mm thick bed of cement mortar 1:3 (1 cement: 3 coarse sand), jointing with grey cement slurry @ 3.3 kg/ sqm including grouting the joint with white cement & matching pigments etc. complete.						
5.09	11.4	52 mm thick cement concrete flooring with concrete hardener topping, under layer 40 mm thick cement concrete 1:2:4 (1 cement : 2 coarse sand : 4 graded stone aggregate 20 mm nominal size) and top layer 12 mm thick cement hardener consisting of mix 1:2 (1 cement hardener mix : 2 graded stone aggregate 6 mm nominal size) by volume, hardening compound mixed @ 2 litre per 50 kg of cement or as per manufacturer's specifications. This includes cost of cement slurry, but excluding the cost of nosing of steps etc. complete.	81.52	Sqm	978.45	79759		/-
6.00	13.0	FINISHING						
6.01	13.11	18 mm cement plaster in two coats under layer 12 mm thick cement plaster 1:5 (1 cement : 5 coarse sand) finished with a top layer 6 mm thick cement plaster 1:6 (1 cement : 6 fine sand).	383.33	Sqm	518.55	198775		/-
6.02	13.21	Extra for providing and mixing water proofing material in cement plaster work in proportion recommended by the manufacturers.	47.99	per bag of 50kg cement used in the mix	22.10	1061		/-

S.No.	DSR/MR	DESCRIPTION	Unit	QTY.	Rate	DSR Amount	Non DSR Amount
1	MR	Supply, Installation, Testing and Commissioning of 20 W LED Tubelight with batten -Basic all purpose surface and wall mounted LED batten with Aluminum housing & integrated electronic driver with all accessories as required complete in all respect. (Havells Cat no. - LUMILINEPLUSBS18WLED865SPCS or Equivalent)	no	32	826.00		26432.00
2	19.1	Supply, Installation, Testing and Commissioning of 1200 mm sweep, BEE 5 star rated, ceiling fan with Brush Less Direct Current (BLDC) Motor, class of insulation: B, 3 nos. blades, 30 cm long down rod, 2 nos. canopies, shackle kit, safety rope, copper winding, Power Factor not less than 0.9, Service Value (CMM/W) minimum 6.85, Air delivery minimum 215 CMM, 350 RPM (tolerance as per IS : 374- 2019), THD less than 10%, remote or electronic regulator unit for speed control and all remaining accessories including safety pin, nut bolts, washers, temperature rise=75 degree C (max.), insulation resistance more than 2 mega ohm, suitable for 230 V, 50 Hz, single phase AC Supply, earthing etc. complete as required.	Each	8	2730.00	21840.00	
3	1.45	Installation, testing and commissioning of ceiling fan including wiring the down rods of standard length (upto 30 cm) with 1.5 sq. mm FR PVC insulated, copper conductor, single core cable including providing and fixing phenolic sheet cover on the fan box as required etc	Nos.	8	339.00	2712.00	
4	1.10	Wiring for light point/ fan point/ exhaust fan point/ call bell point with 1.5 sq.mm FRLS PVC insulated copper conductor single core cable in surface / recessed medium class PVC conduit, with modular switch, modular plate, suitable GI box and earthing the point with 1.5 sq.mm. FRLS PVC insulated copper conductor single core cable etc as required.		0			
	1.10.3	Group C	Point	24	1467.00	35208.00	
5	1.55	Wiring for group controlled (looped) light point/ fan point/call bell point (without independent switch etc.) with 1.5 sq.mm FRLS PVC insulated copper conductor single core cable in surface / recessed PVC conduit, and earthing the point with 1.5 sq.mm. FRLS PVC insulated copper conductor single core cable etc as required.		0			
	1.55.3	Group C	Point	16	858.00	13728.00	
6		CABLES		0			
	7.1	Laying of one number PVC insulated and PVC sheathed / XLPE power cable of 1.1 KV grade of following size direct in ground including excavation, sand cushioning, protective covering and refilling the trench etc as required.		0			
	7.1.1	Upto 35 sq. mm	Metre	1400	387.00	541800.00	
7.0	9.1	Supplying and making end termination with brass compression gland and aluminium lugs for following size of PVC insulated and PVC sheathed / XLPE aluminium conductor cable of 1.1 KV grade as required.		0			
	9.1.33	4 X 16 sq. mm (28mm)	EACH	32	309.00	9888	
		LT CABLES		0			
8		Supply and fixing of following XPLE armoured 1.1 KV grade conforming to I.S.7098/1554 Aluminium Conductor Cables :		0			
		Supply of following sizes of PVC sheathed PVC/XLPE insulated Aluminium conductor armoured cable of 1.1 KV grade conforming to IS:7098 part-1 / IS:1554 part-1 respectively & ISI marked.		0			
a	MR	4 C x 16 Sqmm XLPE cable	RM	1400	408.00		571200
9	MR	External lighting panel		0			
		Supplying, installation, testing and commissioning of cubical type outdoor panel with canopy suitable outdoor use for 415 V, 3 Phase, 4 Wire 50 Hz AC supply system fabricated in compartmentalized (preferably) design from CRCA sheet steel of 2 mm thick for frame work and covers, 3 mm thick for gland plates I/C cleaning and finishing complete with 7 tank process for powder coating in approved shade, bus bar supports, with short circuit withstand capacity of 25 MVA for 1 Sec., bottom base channel of MS section not less than 100mm x 50mm x 5mm thick, fabrication shall be done in transportable sections, entire panel shall have a common copper earth bar of size 25 mm x 5 mm at the rear with 2 Nos. earth stud, solid connections from main bus bar to switch gears with required size of Al. bus bars and control wiring with 2.5 sq.mm. PVC insulated copper conductor S/C cable alleys, cable gland plates in two half, I/C providing following switchgears:		0			
		Incomer:1nos 40A TPN MCCB		0			
		1 no 96mm x 96mm digital Voltmeter and Ammeter with LCD display for voltage & current with suitably rated CTs and MCB protection.		0			
		1 set of three phase indicating lamps with suitable protection.		0			
		Busbar: Equally sized three phase and neutral copper bus bars suitably sized to carry 100A current with colour coded heat shrinkable sleeves.		0			
		Outgoing:		0			
		4nos 32A TPN MCBs		0			
		Panel complete as above	Each	4	65000		260000

10		EARTHING		0			
a	5.4	Earthing with G.I. earth plate 600 mm X 600 mm X 3 mm thick including accessories, and providing masonry enclosure with cover plate having locking arrangement and watering pipe of 2.7 metre long etc. with charcoal/ coke and salt as required.	SET	8	7472.00	59776.00	
f	5.15	Providing and fixing 25 mm X 5 mm G.I. strip on surface or in recess for connections etc. as required.	MTR	200	244.00	48800.00	
g	5.16	Providing and fixing 6 SWG dia G.I. wire on surface or in recess for loop earthing as required.	MTR	200	70.00	14000.00	
		GRAND TOTAL				747752	857632

SECTION – XI DRAWINGS

GENERAL NOTES:-

1. ALL DIMENSIONS ARE IN MM.
2. DO NOT SCALE ANY DIMENSIONS.
3. CONFIRM LOCATION OF WALLS WITH RELEVANT ARCH. DRGS.
4. FOR R.C.C. WORK USE MIX M25 CONFORMING TO IS 456 : 2000 OR AS SPECIFIED IN RESPECTIVE DWG.
5. THE REINFORCEMENT SHALL BE T.M.T. BARS HAVING YIELD STRENGTH NOT LESS THAN 500 N/mm² AND CONFORMING TO I.S. 1786 - 2008.
6. THE CLEAR COVER TO THE REINFORCEMENT SHALL BE AS FOLLOWS:-

(a) FOUNDATION	
RAFT BOTTOM	60 MM
RAFT TOP & SIDE	50 MM
(b) COLUMNS	40 MM
(c) BEAMS (top & bottom)	25 MM side cover 25mm
(d) SLABS	20 MM
(e) CHAJJAS/CONOPY	20 MM
(f) R.C.C. WALL	25 MM
10. THE LAPS IN BARS SHALL BE STAGGERED & AT ONE PLACE SHALL NOT BE MORE THAN 50 PERCENT.
11. INDICATES TOP BARS
 INDICATES BOTTOM BARS
12. READ THIS DRAWING IN CONJUNCTION WITH RELEVANT ARCHITECTURAL DRAWINGS. ANY DISCREPANCY IF FOUND SHALL BE BROUGHT TO THE NOTICE OF CONSULTANT.
13. ALL R C C TO BE MACHINE MIXED AND VIBRATED AND CURED THOROUGHLY AS PER I.S 456-LATEST.

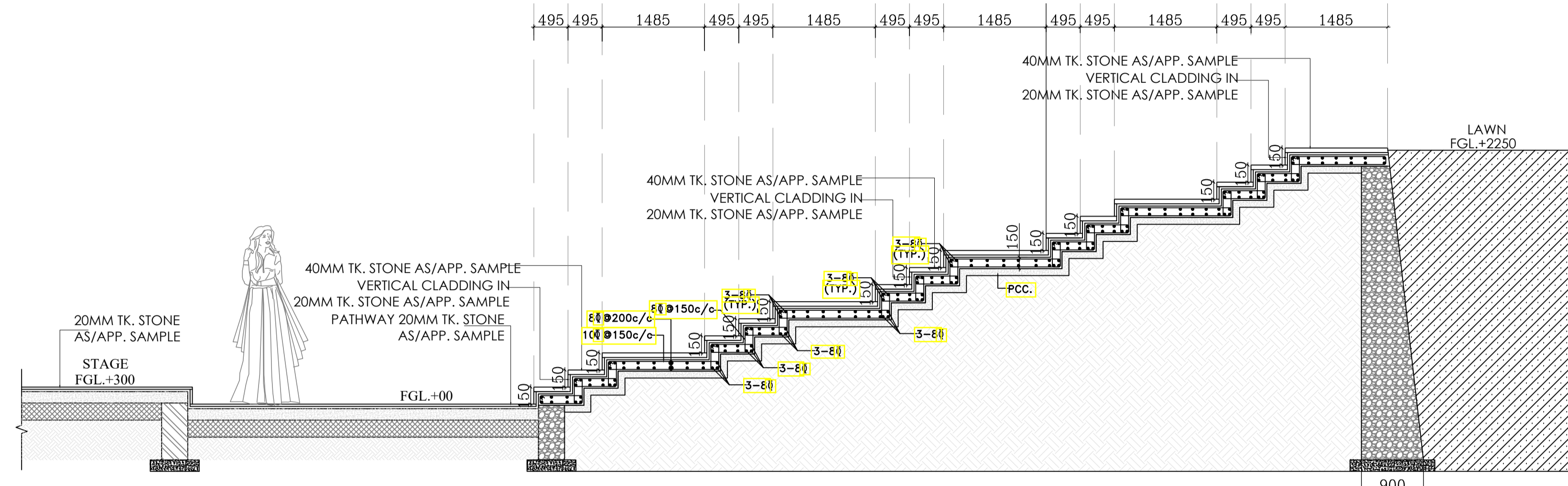
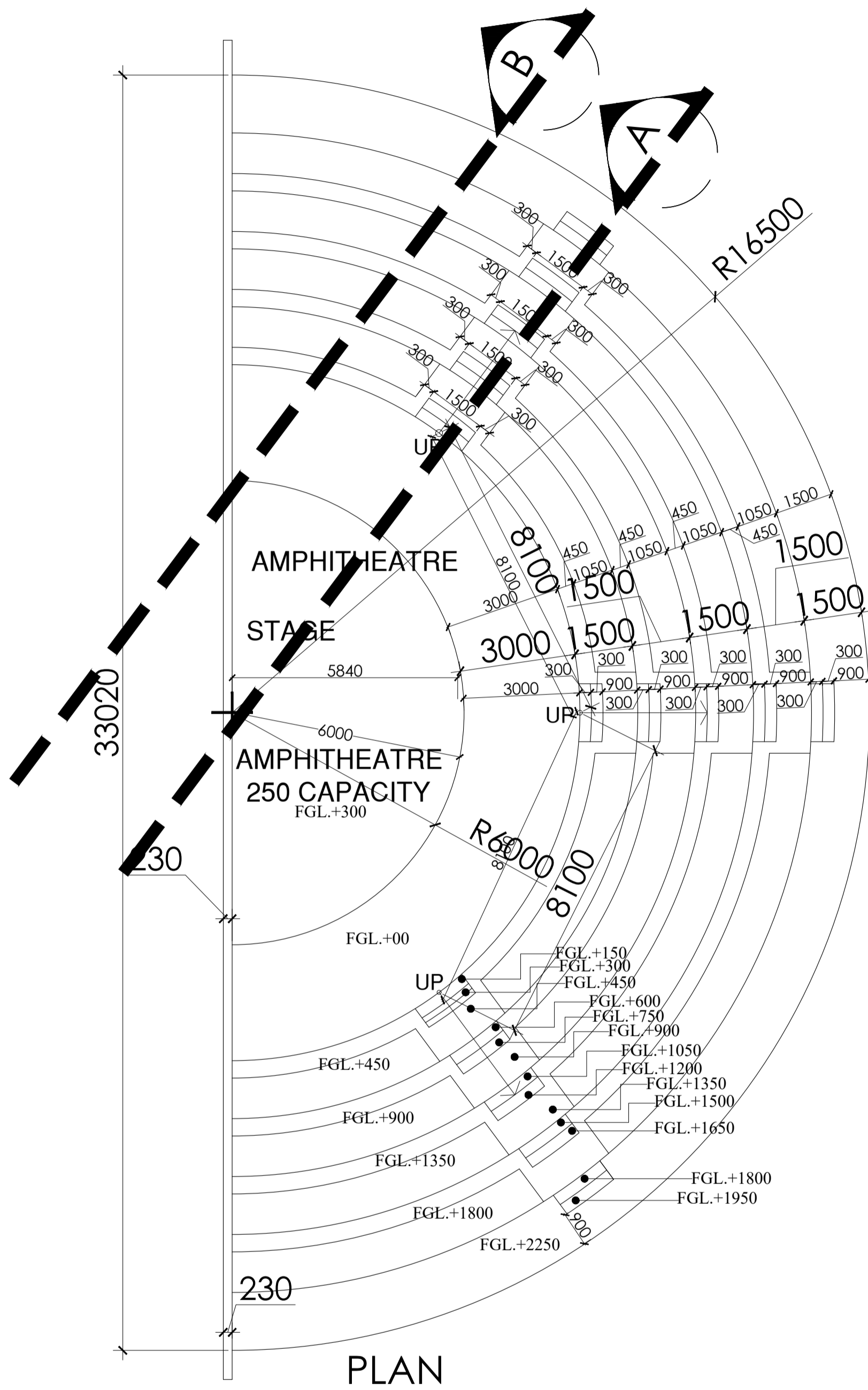

SECTION -B

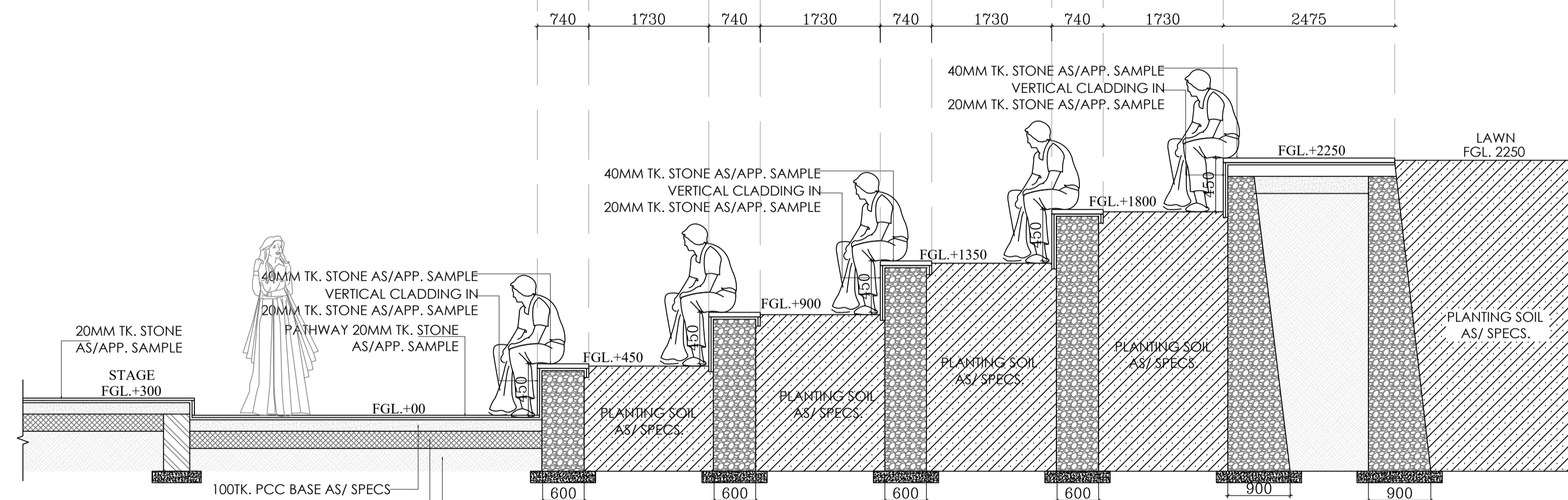

SECTION -A-A

R0	FOR APPROVAL ONLY	02.12.2024
----	-------------------	------------

REVISION	DESCRIPTION	DATE

PURPOSE OF DRAWING		
GOOD FOR CONSTRUCTION	TENDER	INFORMATION ONLY
<input type="checkbox"/>	<input checked="" type="checkbox"/>	<input type="checkbox"/>
<input type="checkbox"/>	<input type="checkbox"/>	<input type="checkbox"/>
PROOF CHECKING APPROVAL ONLY SUBMISSION DRAWING		
<input type="checkbox"/>	<input type="checkbox"/>	<input type="checkbox"/>

PROJECT : NATIONAL INSTITUTE OF AYURVEDA, JAIPUR JAGGA KI BAWRI

TITLE : AMPHITHEATRE DETAIL

SCALE	DRAWN BY:-	REV.NO.
NTS	ZEHRA	
	DESIGNED BY:-	
	FARHAN	
DATE	CKD.BY:-	
02.12.2024	NAUMAN	R0

ARCHITECT :

THIS DRAWING IS THE COPYRIGHT OF THE CONSULTANTS AND MAY BE USED OR REPRODUCED ONLY WITH HIS PRIOR PERMISSION.

GENERAL NOTES:-

- ALL DIMENSIONS ARE IN MM.
- DO NOT SCALE ANY DIMENSIONS.
- CONFIRM LOCATION OF WALLS WITH RELEVANT ARCH. DRGS.
- FOR R.C.C. WORK USE MIX AS/COLUMN SCHEDULE CONFORMING TO IS 456 : 2000 OR AS SPECIFIED IN RESPECTIVE DWG.
- THE REINFORCEMENT SHALL BE T.M.T. BARS HAVING YIELD STRENGTH NOT LESS THAN 500 N/mm² AND CONFORMING TO I.S. 1786 - 2008.
- THE CLEAR COVER TO THE REINFORCEMENT SHALL BE AS FOLLOWS:-

(a) FOUNDATION	
RAFT BOTTOM	: 60 MM
RAFT TOP & SIDE	: 50 MM
(b) COLUMNS	: 40 MM
(c) BEAMS (top & bottom)	: 25 MM side cover 25mm
(d) SLABS	: 20 MM
(e) CHAJJAS/CONOPY	: 20 MM
(f) R.C.C. WALL	: 25 MM
- THE LAPS IN BARS SHALL BE STAGGERED & AT ONE PLACE SHALL NOT BE MORE THAN 50 PERCENT.
- INDICATES TOP BARS
----- INDICATES BOTTOM BARS
- READ THIS DRAWING IN CONJUNCTION WITH RELEVANT ARCHITECTURAL DRAWINGS. ANY DISCREPANCY IF FOUND SHALL BE BROUGHT TO THE NOTICE OF CONSULTANT.
- SLEEVES TO BE MARKED BEFORE ERECTION OF R.C.C. TO AVOID CORE CUTTING ON A LATER STAGE.
- PLEASE ADD NOTES RELATED TO PROVIDE R.C.C. BAND IN WALLS AT EVERY 2400MM.
- SHOP DRAWINGS NEED TO BE APPROVED FROM ARCH/STRUCTURE ENGG. EXECUTION FOR SPECIAL STRUCTURES LIKE STRUCTURAL GLAZING, VERTICAL ALUMINUM LOUVERS, A.C.P. ETC.(SHOP DRAWING & DESIGN REPORT), WHICH ARE DIRECTLY OR INDIRECTLY SUPERIMPOSING THE LOAD ON STRUCTURE.
- ALL R C C TO BE MACHINE MIXED AND VIBRATED AND CURED THOROUGHLY AS PER I.S 456-LATEST.
- SAFE BEARING CAPACITY OF 32T/M² HAS BEEN CONSIDERED

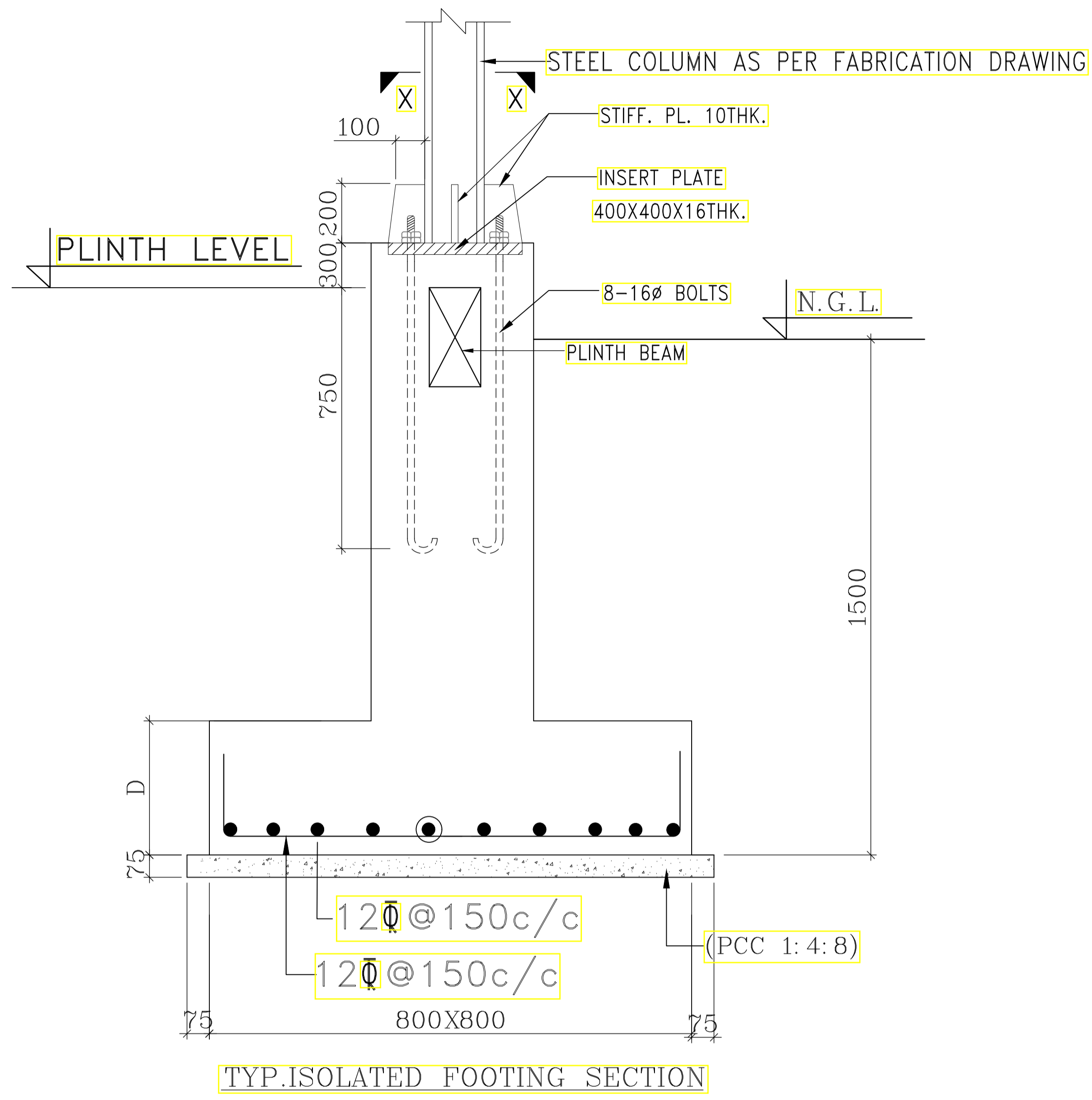

COLUMN SCHEDULE

LEVEL	COLUMN SIZE	FOUNDATION LVL. TO TERMINATION	TIES
MIX		M25	
C1	500 500 A B C B A B C B A B C B A	A = 4-16Ø B = 8-16Ø C = 4-16Ø	INDICATES TIES SPECIFICATION AS/LEGEND



Product Code: CIGZC-12
Dimension: 15ft x 15ft
Design: Hexagonal Gazebo
Material: Cast Iron

LEGEND FOR LATERAL TIES

LEGEND	ZONE	TIES SPECIFICATION
S	A	8Ø@100c/c OUTER TIES
		+8Ø@100c/c INNER TIES
	B	8Ø@200c/c OUTER TIES
		+8Ø@200c/c INNER TIES

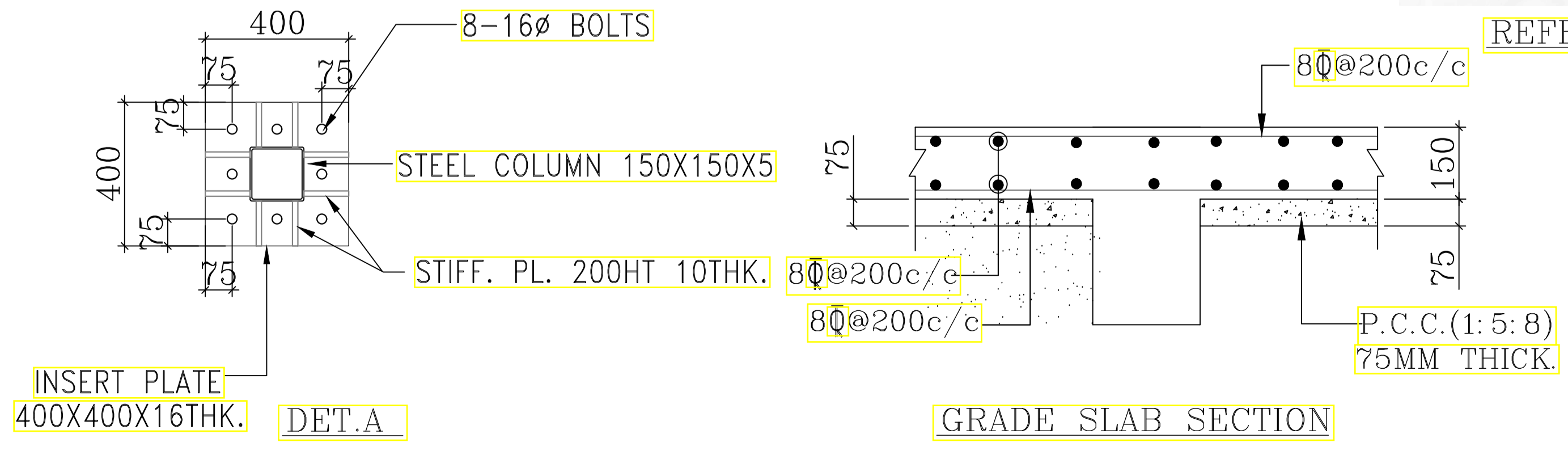

TENDER DRAWING

REV NO.	DESCRIPTION	DATE
	REVISION	

EXECUTING AGENCY :-

WAPCOS LIMITED
 (A Government of India Undertaking)
 Ministry of Jal Shakti
 ISO 9001:2015

PROJECT : **NATIONAL INSTITUTE OF AYURVEDA, JAIPUR JAGGA KI BAWRI**

DRAWING TITLE : **NIA JAGGA KI BAWRI GAZEBO DETAIL**

SCALE: NTS	NAME	DATE
	DESIGNED: RM	
	DRAWN: LALIT TIWARI	
	CHECKED: RM	07-01-25
	APPROVED: ---	

PROJECT NO.: DRG NO.: **WT - 01** REV: **R0** SHEET: ---

ARCHITECT
YETINDER MATHUR
 U-21 Green Park Extension, New Delhi-110016

DRAWING RELEASED FOR:

APPROVAL ONLY INFORMATION
 ADVANCE COPY CONSTRUCTION

ARCHITECT'S SIGN _____ OWNER'S SIGN _____

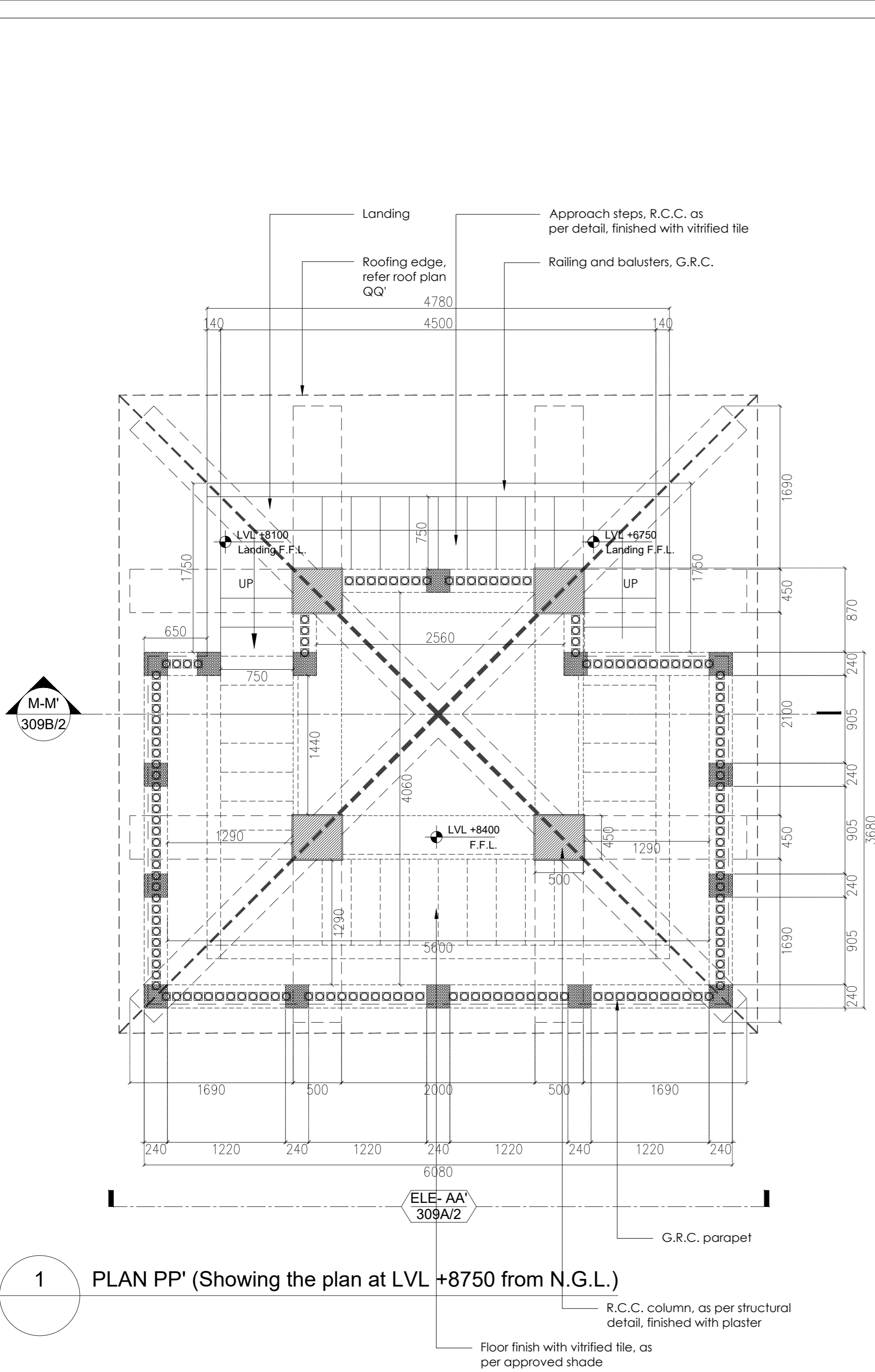

1 PLAN PP' (Showing the plan at LVL +8750 from N.G.L.)

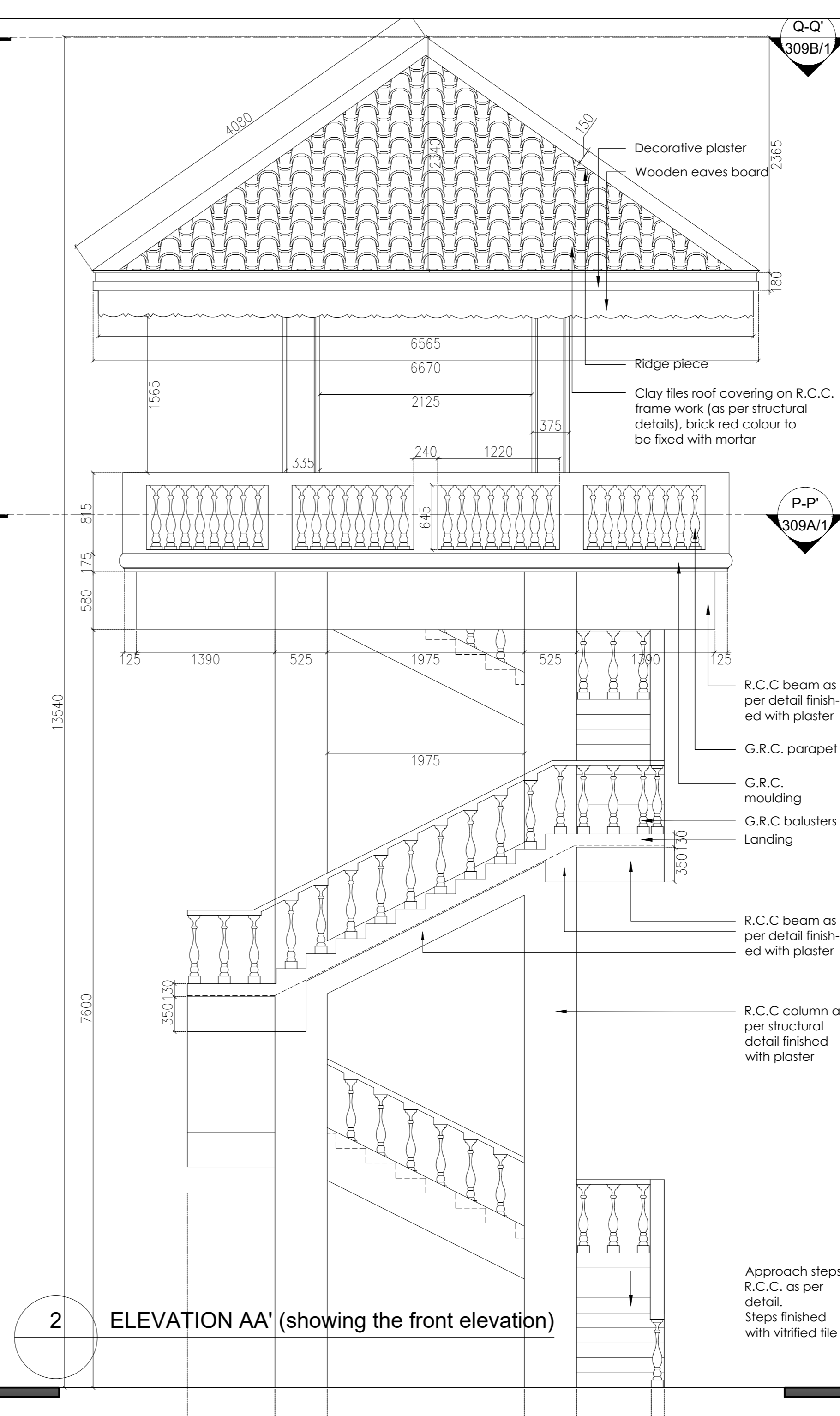

2 ELEVATION AA' (showing the front elevation)

Note:
 • All finishing shades, tile specifications, G.R.C. specifications as per approval

REV NO	DESCRIPTION	REVISION	DATE

EXECUTING AGENCY :-

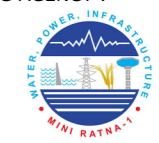

WAPCOS LIMITED
 (A Government of India Undertaking)
 Ministry of Jal Shakti
 ISO 9001:2015

PROJECT : **NATIONAL INSTITUTE OF AYURVEDA ,JAIPUR JAGGA KI BAWRI**
TENDER DRAWING

DRAWING TITLE : **WATCH TOWER PLAN & ELEVATION**

SCALE	DESIGNED	NAME	DATE
NTS	RM		
	SANGEETA		
	RM		09-07-24

PROJECT NO : DRG NO : **A-01** REV : **00** SHEET :



ARCHITECT
YETINDER MATHUR
 U-21 Green Park Extension, New Delhi-110016

DRAWING RELEASED FOR:

<input type="checkbox"/> APPROVAL	<input type="checkbox"/> ONLY INFORMATION
<input type="checkbox"/> ADVANCE COPY	<input type="checkbox"/> CONSTRUCTION

ARCHITECT'S SIGN OWNER'S SIGN

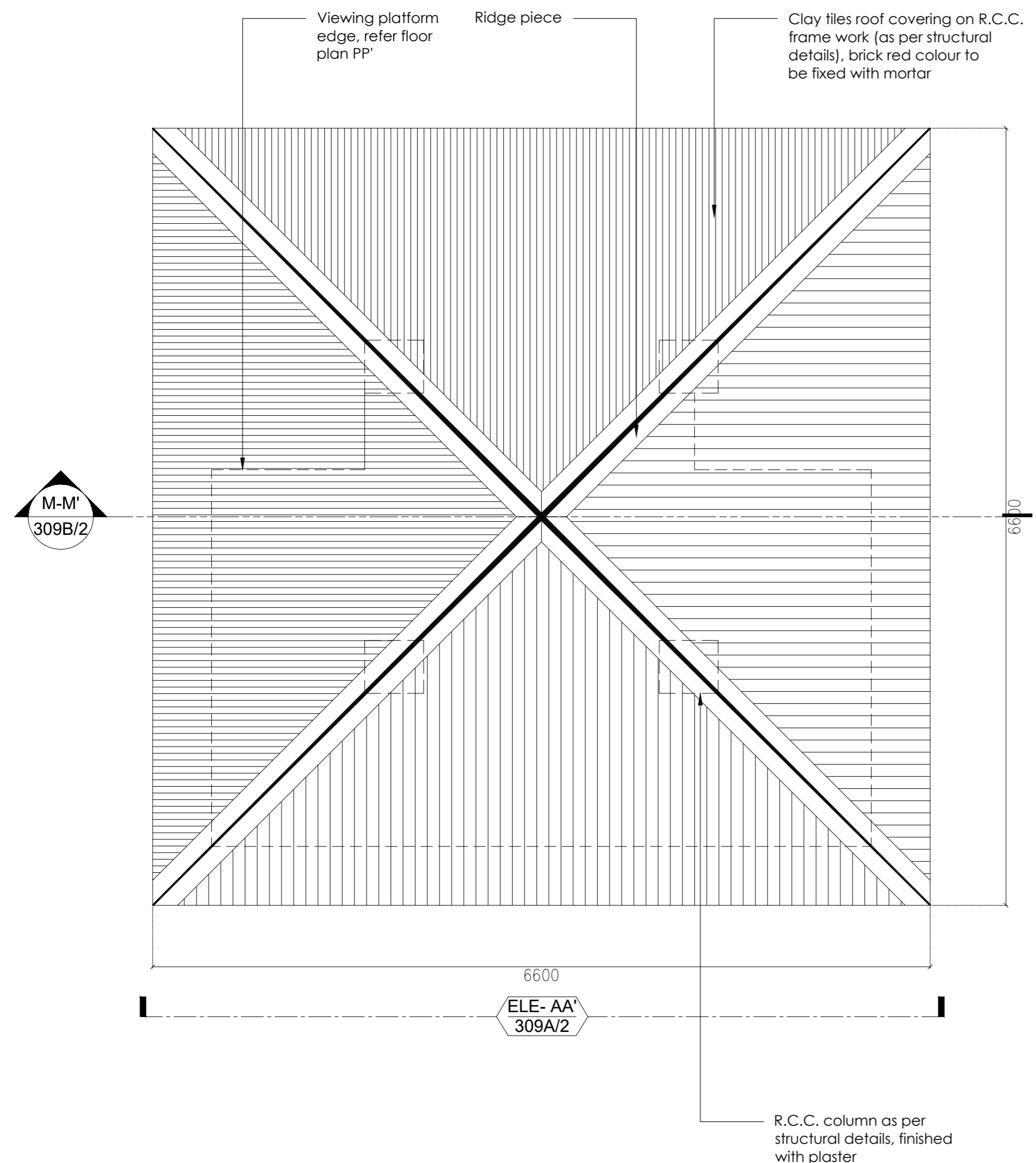

1 PLAN QQ' (Showing the roofing plan at LVL +13500 from N.G.L.)

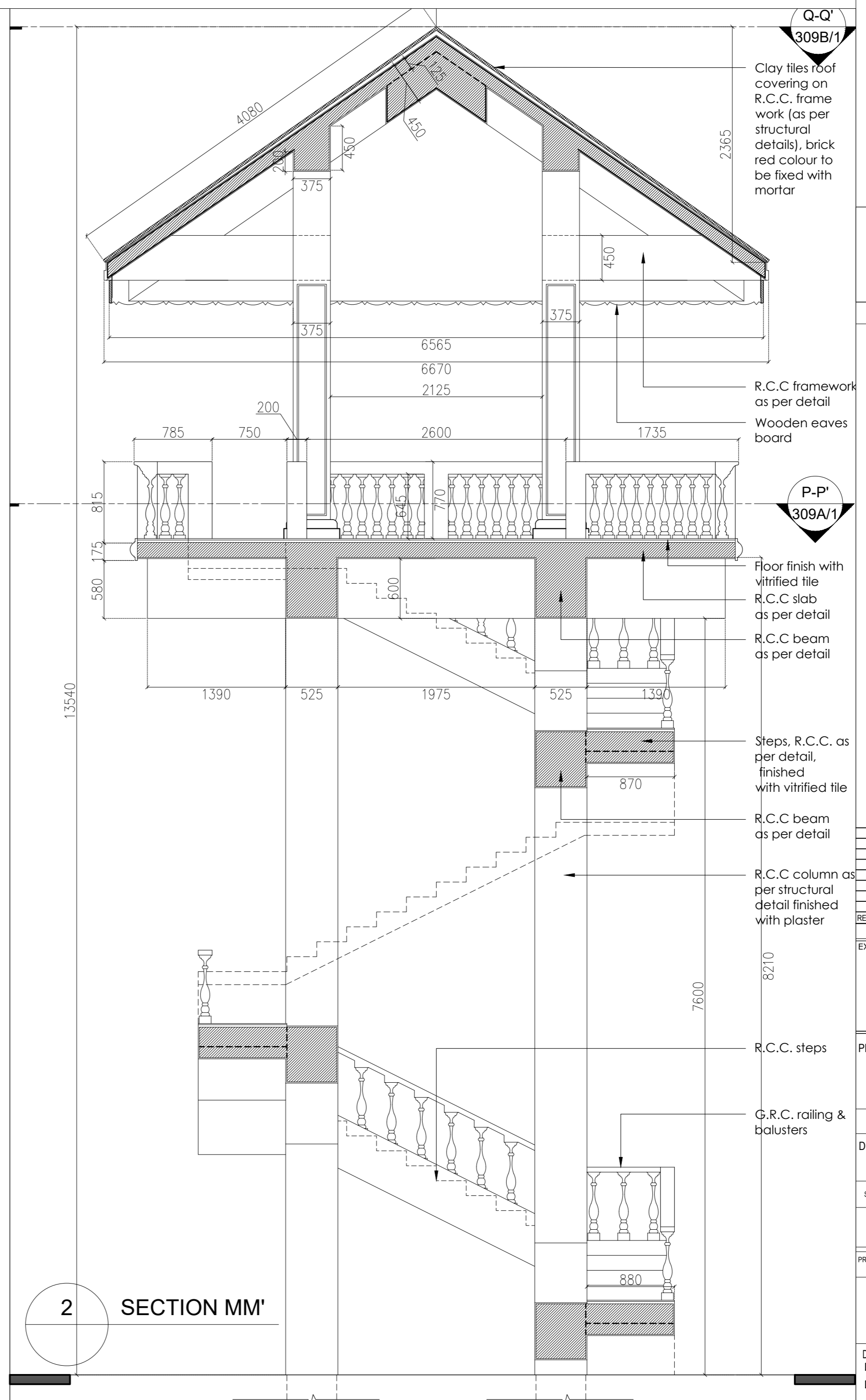

2 SECTION MM'

REV NO	DESCRIPTION	DATE

EXECUTING AGENCY :-



WAPCOS LIMITED
(A Government of India Undertaking)
Ministry of Jal Shakti
ISO 9001:2015

PROJECT : NATIONAL INSTITUTE OF AYURVEDA, JAIPUR JAGGA KI BAWRI

TENDER DRAWING

DRAWING TITLE : WATCH TOWER ROOF PLAN & SECTION

SCALE	NAME	DATE
NTS	DESIGNED	RM
	DRAWN	SANGEETA
	CHECKED	RM
	APPROVED	...

PROJECT NO :	DRG NO :	REV :	SHEET :
	A-02	00	

ARCHITECT
YETINDER MATHUR
U-21 Green Park Extension, New Delhi-110016

DRAWING RELEASED FOR:

APPROVAL ONLY INFORMATION

ADVANCE COPY CONSTRUCTION

ARCHITECT'S SIGN _____ OWNER'S SIGN _____

