



WAPCOS LIMITED

(भारत सरकार का उपक्रम)

जल शक्ति मंत्रालय

(A Government of India Undertaking)

Ministry of Jal Shakti

TENDER DOCUMENT FOR

Construction of Eklavya Model Residential School at Jaldega,
District Simdega, Jharkhand

WAP/CMU-I/2023-24/ NESTS/JH/JALD/16

Date: 11-08-2023

WAPCOS LIMITED

1st floor, Plot no. 148, Sector- 44, Gurugram,
Haryana-122015

August, 2023

TABLE OF CONTENT

| NOTICE INVITING TENDER (NIT) | |
|-------------------------------------|--|
| SECTION: I | INSTRUCTIONS TO BIDDER |
| SECTION: II | SELECTION AND QUALIFYING CRITERIA |
| SECTION: III | FORMS |
| | Letter of Transmittal for Technical Bid and Financial bid along with Declaration by the Bidder |
| FORM - A | Financial Information |
| FORM-B | Solvency Certificate |
| FORM - C | Correspondence Details Of Issuing Authority |
| FORM - D | Bid Capacity |
| FORM - E | Structure & Organization |
| FORM - F | Undertaking For Manpower Deployment |
| FORM - G | No Conviction Certificate |
| FORM - H | No Deviation Certificate |
| FORM - I | Undertaking Regarding Blacklisting / Non Debarment |
| FORM - J | Undertaking For Restriction Under Rule 144(XI) Of GFRs |
| FORM-K | Preference To Make In India |
| FORM - L | Letter For Integrity And Integrity Agreement |
| FORM-M | Performance of Bidder In EMRS Projects |
| FORM-N | Understanding The Project Site |
| | |
| SECTION: IV | GENERAL CONDITIONS OF CONTRACT |
| SECTION: V | SPECIAL CONDITIONS OF CONTRACT |
| | |
| SECTION: VI | ANNEXURES |
| ANNEXURE - I | Format For Contract Agreement And Letter Of Award |
| ANNEXURE - II | Format For Performance Bank Guarantee |
| ANNEXURE - III | Format For Mobilization Advance Payment Bank Guarantee |
| ANNEXURE - IV | Format For Indenture For Secured Advances |
| ANNEXURE - V | Format Of Bank Guarantee For EMD |
| ANNEXURE - VI | Format For Seeking Extension Of Time |
| ANNEXURE - VII | Format Of Guarantee Bond /Affidavit For Works |
| ANNEXURE - VIII | Contract For Removal Of Defects After Completion In Respect Of Water Proofing Works |
| ANNEXURE - IX | Format For Guarantee Bonds For Anti-Termite Treatment |
| ANNEXURE - X | Safety Codes |
| ANNEXURE - XI | Model Rules For The Protection Of Health And Sanitary Arrangements For Workers Employed By Contractors |
| ANNEXURE - XII | Contractor's Labour Regulations |
| | |
| SECTION VII | GENERAL TECHNICAL SPECIFICATION OF WORK |
| | |
| SECTION VIII | SCOPE OF WORK |
| | |
| SECTION IX | TENDER DRAWINGS |
| | |
| SECTION X | FINANCIAL PROPOSAL |

NOTICE INVITING TENDER (NIT)

NOTICE INVITING TENDER (NIT)

NIT No. WAP/CMU-I/2023-24/NESTS/JH/JALD/16

Dated 11-08-2023

WAPCOS Limited (A Govt. of India Undertaking) on behalf of National Education Society for Tribal Students (NESTS), invites open online Percentage Rate tender from experienced, competent and eligible bidders in a two-envelope system as per below:

| | | |
|----|---|--|
| 1. | Work/ Project | Construction of Eklavya Model Residential School at Jaldega, District Simdega, Jharkhand |
| 2. | Site / Location | Jaldega, District Simdega, Jharkhand |
| 3. | Website for viewing tender, Corrigendum/ Addendum, if any. | www.wapcos.co.in & www.etenders.gov.in/e procure |
| 4. | Website for Registration/ uploading of Tender | www.etenders.gov.in/e procure |
| 5. | Estimated / NIT Cost | Rs. 29,42,35,499/- excluding GST |
| 6. | Cost of Tender Document | Rs. 23600/- (Rupees Twenty-Three Thousand and Six Hundred Only) as Tender Processing Fee in the form of Demand Draft |
| 7. | Earnest Money Deposit (EMD) / Bid Security | <p>Rs. 39.44 Lakhs (Refundable) in the form of Insurance Surety Bonds/ Account Payee Demand Draft/ Fixed Deposit Receipt/ Banker's Cheque or Payment through RTGS/ NEFT in favor of 'WAPCOS Limited' payable at Gurugram, Haryana.</p> <p>OR</p> <p>A part of EMD is acceptable in the form of Bank Guarantee including e- Bank Guarantee also. In this cases Rs. 19.72 lakhs EMD to be deposited in shape prescribed above and balance Rs. 19.72 lakhs will be accepted in form of Bank Guarantee issued by Nationalized/ Scheduled Commercial Bank approved by Reserve Bank of India (RBI).</p> <p>The bank account as per details: Name of Bank: Indian Overseas Bank Bank Account Number: 193502000000287 IFSC Code: IOBA0001935 Branch Name: National Horticulture Board (NHB) Building, G-85, Industrial Area, Sector-18, Gurugram-122015, Haryana</p> <p>Note: Bid Security shall remain valid for a period of 45 days beyond final bid validity period.</p> |
| 8. | Solvency Certificate addressed to WAPCOS Limited , 76-C, Institution Area, Sector-18, Gurugram, Haryana-122015 | Rs. 11.77 crore in original from a Nationalized/ Scheduled Commercial Bank approved by Reserve Bank of India (RBI). The Certificate should be issued between the publishing of NIT & last date of submission of Bids, including extensions if any and shall be addressed to WAPCOS Limited, 76-C, |

| | | |
|-----|--|---|
| | | Institutional Area, Sector-18, Gurugram, Haryana quoting the name of the work. The certificate should carry name, designation of the bank official, who has the authority to issue Solvency Certificate Note: This Certificates will be verified from the issuing authority by WAPCOS. |
| 9. | Project Completion Period | 18 Months from 15 days after Date of Award or Handing over of Site whichever is later |
| 10. | Bid Validity Period | 90 days from the date of opening of Technical bid |
| 11. | Site Visit | Bidders are advised/encouraged to visit the site for actual assessment of the project site location and its consequences during execution of work |
| 12. | Pre Bid Meeting | 21/08/2023 at 3:00 PM to be held in the office of Sr. General Manager, Construction Management Unit-I |
| 13. | Last date & time for online submission of Technical & Financial Bid | 31/08/2023 up to 15:00 hours |
| 14. | Offline Submission of Technical document, Tender Fees, EMD etc. as detail in Tender for bidders. | 31/08/2023 up to 17:00 hours in the office of Sr. General Manager, Construction Management Unit-I at 1 st Floor, NPCC Building, Plot No. 148, Sector- 44 Gurugram- 122003, Haryana |
| 15. | Online opening of Technical Bid | 01/09/2023 up to 17:00 hours |
| 16. | Online opening of Financial Bid | Intimated to Technical Qualified Bidders. |
| 17. | Ceiling on maximum number of EMRS Works to be awarded by WAPCOS to the Single Contractor | <ol style="list-style-type: none"> The bidders shall be entitled to award and execute only 4 EMRSs works of WAPCOS at a time. The bidders, executing 4 or more EMRS works of WAPCOS, are not allowed to participate in the tenders. <p>If any bidder submits the bids for more than 4 EMRSs works of WAPCOS and found L-1, upon opening of financial bid, in more than 4 EMRSs of WAPCOS, the L-1 bidder will be awarded only 4 EMRSs of his choice and the balance EMRSs shall be withdrawn from the L-1 Bidder. In that case, L-2 bidder shall accept and execute the works, withdrawn by the L-1, on the rates and price quoted by the L-1 bidder. If the L-2 bidder does not accept the L-1 rates, the tender shall be cancelled and re-tendered.</p> |
| 18. | Tender Inviting Authority & Communication address during Tendering and Execution of Works | <p>Sr. General Manager Construction Management Unit-I 1st floor, Plot no. 148, Sector- 44, Gurugram, Haryana-122003 Email: buildings@wapcos.co.in Contact No. +91124-4488018</p> |
| 19. | The Bid Security/ EMD / Solvency Certificate / BG against Performance Security/ BG against Mobilization Advance/ shall be addressed to WAPCOS Corporate Office | <p>WAPCOS Limited 76-C, Institution Area Sector-18, Gurugram, Haryana-122015</p> |

- The tender document has to be viewed/ downloaded from above specified websites. Bidders are advised to visit above specified websites regularly for updates /Amendments/ Corrigendum, if any and not be published elsewhere. The Updates/Corrigendum/Addendum shall be followed up to submission of tender and it will be the part of tender.
- The purpose of this NIT is to provide interested parties with information to assist the preparation of their bid. While WAPCOS Limited has taken due care in the preparation of the information contained herein, and believe it to be complete and accurate, neither it nor any of its authorities or agencies nor any of its respective officers, employees, agents or advisors give any warranty or make any representations, expressed or implied as to the completeness or accuracy of the information contained in this document or any information which may be provided in association with it. The Bidders must read all the terms and conditions of bidding document carefully and only submit the bid, if eligible and in possession of all the documents required. Corrigendum while all efforts have been made to avoid errors in the drafting of the tender documents, the Bidder is advised to check the same carefully. No claim on account of any errors detected in the tender documents shall be entertained.
- Further, WAPCOS Limited does not claim that the information is exhaustive. Respondents to this NIT are required to make their own inquiries/ surveys and will be required to confirm, in writing, that they have done so and they did not rely solely on the information in NIT. WAPCOS Limited is not responsible if no due diligence is performed by the bidders.
- If the office of WAPCOS Limited happens to be closed on the last date and time mentioned for any of the event, the said event will take place on the next working day at the same time and venue.
- WAPCOS Ltd. reserves the right to accept or reject any or all bids without assigning any reasons. No Bidder shall have any cause of action or claim against the WAPCOS Ltd. For rejection of his Bid and will not be bound to accept the lowest or any other tender.
- No reimbursement of cost of any type or on any account will be paid to persons or entities submitting their Bid.
- All information submitted in response to this NIT shall be the property of WAPCOS Limited and it shall be free to use the concept of the same at its will.
- It is hereby declared that WAPCOS is committed to follow the principle of transparency, equity and competitiveness in public procurement. The subject Notice Inviting Tender (NIT) is an invitation to offer made on the condition that the Bidder will sign the integrity Agreement, which is an integral part of tender/bid documents, failing which the tenderer/bidder will stand disqualified from the tendering process and the bid of the bidder would be summarily rejected. This declaration shall form part and parcel of the Integrity Agreement and signing of the same shall be deemed as acceptance and signing of the Integrity Agreement on behalf of the WAPCOS.

For and on behalf of WAPCOS LIMITED
Sr. General Manager

SECTION-I

INSTRUCTIONS TO BIDDER

SECTION- I INSTRUCTIONS TO BIDDER

1.0 SPECIAL INSTRUCTIONS TO BIDDERS FOR E-TENDERING

1.1 GENERAL

Submission of Online Bids is mandatory for this Tender. E-Tendering is a methodology for conducting Public Procurement in a transparent and secured manner. For conducting electronic tendering, bidders shall use the portal www.etenders.gov.in/eprocure. Tender is invited in Single Stage -Two Envelope system, one Technical Bid and second as financial bid. Accordingly, bidder is directed to make all formalities and registration on www.etenders.gov.in/eprocure website and submit the Technical Bid and Financial bid.

The bidders are required to submit soft copies of their bids electronically on the CPP Portal, using valid Digital Signature Certificates. The instructions given below are meant to assist the bidders in registering on the CPP Portal, prepare their bids in accordance with the requirements and submitting their bids online on the CPP Portal.

More information useful for submitting online bids on the CPP Portal may be obtained from website: <https://etenders.gov.in/eprocure/app> .

1.2 REGISTRATION

- a) Bidders are required to enroll on the e-Procurement module of the Central Public Procurement Portal (URL: <https://etenders.gov.in/eprocure/app>) by clicking on the link “Online bidder Enrollment” on the CPP Portal which is free of charge.
- b) As part of the enrolment process, the bidders will be required to choose a unique username and assign a password for their accounts.
- c) Bidders are advised to register their valid email address and mobile numbers as part of the registration process. These would be used for any communication from the CPP Portal.
- d) Upon enrolment, the bidders will be required to register their valid Digital Signature Certificate (Class III Certificates with signing key usage) issued by any Certifying Authority recognized by CCA India (e.g. Sify / nCode / eMudhra etc.), with their profile.
- e) Only one valid DSC should be registered by a bidder. Please note that the bidders are responsible to ensure that they do not lend their DSC’s to others which may lead to misuse.
- f) Bidder then logs in to the site through the secured log-in by entering their user ID /password and the password of the DSC / e-Token.

1.3 SEARCHING FOR TENDER DOCUMENTS

- a) There are various search options built in the CPP Portal, to facilitate bidders to search active tenders by several parameters. These parameters could include Tender ID, Organization Name, Location, Date, Value, etc. There is also an option of advanced search for tenders, wherein the bidders may combine a number of search parameters such as Organization Name, Form of Contract, Location, Date, Other keywords etc. to search for a tender published on the CPP Portal.
- b) Once the bidders have selected the tenders they are interested in, they may download the required documents / tender schedules. These tenders can be moved to the respective ‘My Tenders’ folder. This would enable the CPP Portal to intimate the bidders through SMS / e- mail in case there is any corrigendum issued to the tender document.
- c) The bidder should make a note of the unique Tender ID assigned to each tender, in case they want to obtain any clarification / help from the Helpdesk.

1.4 PREPARATION OF BIDS

- a) Bidder should take into account any corrigendum, Addendum published on the web portal along with tender document before submitting their bids.
- b) Bidder should read the tender document, corrigendum, Addendum and any other related correspondence, carefully to understand the documents required to be submitted as part of the bid.
- c) Bidder, in advance, should get ready the bid documents to be submitted as indicated in the tender document / schedule and generally, they can be in PDF / XLS / RAR / DWF/JPG formats. Bid documents may be scanned with 100 dpi with black and white option which helps in reducing size of the scanned document.

1.5 SUBMISSION OF BIDS

- a) Please uninstall any Java version if installed already. Then go to this link <https://eprocure.gov.in/cppp/jre-windows-i586.exe> and download this prescribed version of java for this portal.
- b) Bidder should log into the site well in advance for bid submission so that they can upload the bid in time i.e. on or before the bid submission time. Bidder will be responsible for any delay due to other issues.
- c) Bidder should log into the site well in advance for bid submission so that they can upload the bid in time i.e. on or before the bid submission time. Bidder will be responsible for any delay due to other issues.
- d) The bidder has to digitally sign and upload the required bid documents one by one as indicated in the tender document.
- e) Bidder has to select the payment option as “offline” to pay the tender fee / EMD as applicable and enter details of the instrument.
- f) Bidder should prepare the EMD as per the instructions specified in the tender document. The original should be posted/couriered/given in person to the concerned official, latest by the last date of bid submission or as specified in the tender documents. The details of the DD/any other accepted instrument, physically sent, should tally with the details available in the scanned copy and the data entered during bid submission time. Otherwise the uploaded bid will be rejected.
- g) Bidders are requested to note that they should necessarily submit their financial bids in the format provided and no other format is acceptable. If the price bid has been given as a standard BoQ format with the tender document, then the same is to be downloaded and to be filled by all the bidders. Bidders are required to download the BoQ file, open it and complete the white coloured (unprotected) cells with their respective financial quotes and other details (such as name of the bidder). No other cells should be changed. Once the details have been completed, the bidder should save it and submit it online, without changing the filename. If the BoQ file is found to be modified by the bidder, the bid will be rejected.
- h) The server time (which is displayed on the bidders’ dashboard) will be considered as the standard time for referencing the deadlines for submission of the bids by the bidders, opening of bids etc. The bidders should follow this time during bid submission.
- i) All the documents being submitted by the bidders would be encrypted using PKI encryption techniques to ensure the secrecy of the data. The data entered cannot be viewed by unauthorized persons until the time of bid opening. The confidentiality of the bids is maintained using the secured Socket Layer 128 bit encryption technology. Data storage encryption of sensitive fields is done. Any bid document that is uploaded to the server is subjected to symmetric encryption using a system generated symmetric key. Further this key is subjected to asymmetric encryption using buyers/bid opener’s public keys. Overall, the uploaded tender documents become readable only after the tender opening by the authorized bid openers.

- j) The uploaded tender documents become readable only after the tender opening by the authorized bid openers.
- k) Upon the successful and timely submission of bids (i.e. after Clicking “Freeze Bid Submission” in the portal), the portal will give a successful bid submission message & a bid summary will be displayed with the bid no. and the date & time of submission of the bid with all other relevant details.
- l) The bid summary has to be printed and kept as an acknowledgement of the submission of the bid. This acknowledgement may be used as an entry pass for any bid opening meetings.

2.0 INSTRUCTIONS TO BIDDER

The purpose of these instructions to serve as a guide to Bidders for preparing offer for carrying out the project in all respect.

- a) Submission of a tender by a tenderer implies that the bidder has read Each Section of Tender Document, Corrigendum, Addendum and other related correspondence and has made himself aware about the complete scope of work under the tender document. Accordingly, Contract shall be governed by each Section of Tender Document and all other Conditions mentioned in the tender documents.
- b) WAPCOS Limited desires that the bidders, suppliers, and sub-contractors under the Project, observe the highest standard of ethics during the performance, procurement and execution of such contracts. In pursuance of this requirement, WAPCOS Limited, defines, for the purposes of this provision, the terms set forth below:
 - i. “Corrupt Practice” means the offering, giving, receiving, or soliciting, directly or indirectly, anything of value to influence improperly the actions of another party;
 - ii. “Fraudulent Practice” means any act of submission of forged documentation, or omission, including a misrepresentation, that knowingly or recklessly misleads, or attempts to mislead, a party to obtain a financial or other benefit or to avoid an obligation, or to succeed in a competitive bidding process;
 - iii. “Coercive Practice” means impairing or harming, or threatening to impair or harm, directly or indirectly, any party or the property of the party to influence improperly the actions of a party;
 - iv. “Collusive Practice” means an arrangement between two or more parties designed to achieve an improper purpose, including influencing improperly the actions of another party.

Will reject the award of Contract, even at a later stage, if it determines that the bidder recommended/ selected for award/awarded has, directly or through an agent, engaged in Corrupt, Fraudulent, Collusive, Or Coercive Practices in competing for the Contract;

Will sanction a party or its successors, including declaring ineligible, either indefinitely or for a stated period of time, to participate in any further bidding/procurement proceedings under the Project, if it at any time determines that the party has, directly or through an agent, engaged in Corrupt, Fraudulent, Collusive, Or Coercive Practices in competing for, or in executing, the contract; and the party may be required to sign an Integrity Pact, if required; and WAPCOS Limited will have the right to require the bidders, or its suppliers, contractors and consultants to permit WAPCOS Limited to inspect their accounts and records and other documents relating to the bid submission and contract performance and to have them audited by auditors appointed by WAPCOS Limited at the cost of the bidders.

The Bidder must obtain for himself on his own responsibility and at his own expenses all the information which may be necessary for the purpose of making a bid and for entering into a contract, must examine the Drawings, must inspect the sites of the work, acquaint himself with all local conditions, means of access to the work, nature of the work and all matters pertaining thereto. WAPCOS Limited will in no case be responsible or liable for those costs, regardless of

the conduct or outcome of the bidding process.

- a) All Bidders are hereby explicitly informed that conditional offers or offers with deviations from the Conditions of Contract, the bids not meeting the minimum eligibility criteria, Technical Bids not accompanied with EMD and Tender Document Fees of requisite amount in acceptable format, Bids in altered/modified formats, or in deviation with any other requirements stipulated in the tender documents are liable to be rejected.
- b) The company reserves the right to waive minor deviations if they do not materially affect the capability of the Tenderer to perform the contract
- c) The bidders shall not tamper or modify any part of the tender documents in any manner. In case in part of the bid is found to be tampered or modified at any stage, the bids are liable to be rejected, the contract is liable to be terminated and the full earnest deposit/retention money/performance guarantee will be forfeited and the bidder will be liable to be banned from doing any business with WAPCOS Limited.
- d) Incomplete Price bid shall be liable to be rejected, at the discretion of WAPCOS Limited. The total bid price shall cover the entire scope of works covered in the tender.

3.0 EARNEST MONEY DEPOSIT (EMD) / BID SECURITY

The Earnest Money Deposit shall be as per the details mentioned in NIT. EMD shall not carry any interest. The Bid Security/ EMD of the unsuccessful bidder shall be returned at the earliest after expiry of final bid validity period and latest by 30th days after the award of the contract. Bid Security shall be refunded to the successful bidder on receipt of Performance Security.

The successful bidder shall accept the Letter of Award (LOA) within 15 (Fifteen) days from receipt of the same, failing which the EMD shall be forfeited and the award of work may be liable to be cancelled.

If any bidder withdraws or make any changes in his offer already submitted before the expiry of the validity period or any extension thereof without the written consent of the company, the EMD amount will be forfeited for such act of the bidder.

WAPCOS Limited reserves the right of forfeiture of Earnest Money deposit (EMD) in case of the successful bidder.

- i. After opening of Tender, revokes his tender within the validity period or increases his earlier quoted rates.
- ii. Does not commence the work within the period as per LOA/Contract. In case the LOA/Contract is silent in this regard then within 15 days after award of contract.

The Bid Security will be forfeited in the bidder

- i) withdraws or amends its/ his tender;
- ii) impairs or derogates from the tender in any respect within the period of validity of the tender;
- iii) If the bidder does not accept the correction of his bid price during evaluation; and
- iv) If the successful bidder fails to sign the contract or furnish the required performance security within the specified period.

4.0 LANGUAGE OF BID

The Bid and all related correspondence and documents relating to the Project shall be in English language. Supporting documents and printed literature furnished by the Bidder may be in another language provided they are accompanied by an accurate English translation which shall be certified by a qualified translator. Any material that is submitted in a language other than English and which is not accompanied by an accurate English translation will not be considered.

5.0 BIDDERS RESPONSIBILITY

The Bidder is solely responsible for the details of their Bid and the preparation of bids. In no

case shall the WAPCOS be responsible for any part of the tender documents submitted by him. Any Site information given in this tender document is for guidance only. The Bidder is advised to visit and examine the Site of works and its surroundings at their cost and obtain for themselves on their own responsibility, all information that may be necessary for preparing the tender and entering into a Contract. Irrespective of whether or not the Bidders have attended the pre-bid meeting, they shall be deemed to have inspected the Site and its surroundings beforehand and taken into account all relevant factors pertaining to the Site and clarifications/ modifications/ additions given in Pre-Bid meeting or addendum issued in the preparation and submission of the Bid.

The Bidder shall bear all costs associated with the preparation and submission of his Bid, and the Employer will in no case be responsible and liable for those costs. WAPCOS Limited shall in no case be responsible or liable for these costs, regardless of the conduct or outcome of the bidding process.

6.0 PERIOD OF COMPLETION

The completion period shall be as per NIT. The completion period is for the entire work of planning, execution, approvals, arrangement of materials, equipment, delivery at site including transportation, construction/ installation, testing, commissioning, NoCs & statutory approvals from local bodies and successfully handing over of the entire project to the satisfaction of the Principal Employer/ Employer.

7.0 AMENDMENT OF BID DOCUMENTS

At any time prior to the deadline for submission of bids, the Employer may, for any reason (s), whether at their own initiative or in response to a clarification requested by a prospective Bidder, modify the Bidding Documents by the issuance of a corrigendum/ addendum. No modification of Bid shall be permissible after last date of submission, whatever may be the reason. The Employer may at their discretion may extend the deadline for submission of Tender/ Bid, if considered necessary.

Any corrigendum/ addendum thus issued shall be part of the bidding documents. Prospective Bidders shall download the same from the e-portal and submit along with the submission of Bid as token of acceptance.

8.0 BID VALIDITY PERIOD

Bids validity will be as per NIT. In exceptional circumstances, on expiry / prior to expiry of original bid validity period, the WAPCOS may request the successful bidder for a specified extension in the period of validity. A Bidder may accept OR refuse the request of extension of validity period. A Bidder agreeing Extension of validity period will not be required/nor permitted to modify his bid. In case of refuse of request of extension of validity period tender will be cancelled.

9.0 CURRENCY OF BID

Bid prices shall be quoted in Indian Rupees.

SECTION– II

SELECTION AND QUALIFYING CRITERIA

SECTION-II

SELECTION AND QUALIFYING CRITERIA

1.0 SITE VISIT

- EMRS locations are in remotest part of the country, where deployment of required manpower and supply of materials are major constraints. The intending bidder should have the knowledge about the site constraints such as bad approach road, remote localities etc. which may affect the quality and timely completion of work.
- The intending bidder must be aware of the actual site conditions before bidding and therefore, the site visit is advised in order to avoid impractical and non-serious bids.
- The Intending Bidder(s) are advised to inspect and examine the sites at their own cost and its surroundings and satisfy themselves before submitting their bids as to the nature of the ground and sub-soil (so far as is practicable), the form and nature of the site, the means of access to the site, the accommodation they may require and in general shall themselves obtain all necessary information as to risks, contingencies and other circumstances which may influence or affect their bid. A Bidder(s) shall be deemed to have full knowledge of the site whether he inspects it or not and no extra charge consequent on any misunderstanding or otherwise shall be allowed.
- The bidder and any of its personnel or agents will be granted permission by the Employer/Owner to enter upon its premises and lands for the purpose of such visit, but only upon the express condition that the bidder, its personnel, and agents will release and Indemnify the Employer/Owner and its personnel and agents from and against all liability in respect thereof, and will be responsible for death or personal injury, loss of or damage to property, and any other loss, damage, costs, and expenses incurred as a result of the inspection.

2.0 PRE-BID MEETING

Prospective Bidder requiring any clarification of the bidding documents may notify the Employer via email mentioned in NIT, at least one working day prior to pre-bid meeting. The queries shall be discussed during the pre-bid meeting and the last date for submission of any further queries of Bidders shall be within two days from the date pre-bid meeting. Thereafter no further queries/clarifications shall be entertained. The Employer will reply to only those queries which received before the scheduled time as mentioned above via e-portal which are essentially required for submission of bids. The Employer will not reply to the queries which are not considered fit like replies of which can be implied /found in the NIT/Tender Documents or which are not relevant or in contravention to NIT/Tender Documents.

The intending bidders should depute their authorized person with authorization letter in original to attend the pre-bid meeting. The pre-bid meeting shall be held at the communication address mentioned in NIT. The Addendum/ Corrigendum/Replies to pre bid queries as per Pre bid meeting, shall be uploaded on e-portal & WAPCOS website.

3.0 QUALIFYING CRITERIA: ONLINE TECHNICAL BID SUBMISSION

The intending bidders should only submit bid if he considers himself eligible and possess all the required documents. The Technical Bid shall be uploaded **with coloured scanned copies of following documents. All the documents must be Serial wise as stated below along with check list and clearly marked page no. on each page**

| Content of Check List | | | | |
|---|--|------------|-----------|------------------------------|
| Name of Work: Construction of Eklavya Model Residential School at Jaldega, District Simdega, Jharkhand | | | | |
| S. N | Particular of Document | Yes | No | Page Nos. (from – to) |
| a) | <p>Authority to Sign the Tender</p> <p>a) In case of proprietary firm, the Proprietor shall sign with full name, current address OR by the authorized person holding Notarized Power of Attorney issued by the Proprietor for signing of business proposal. The Power of Attorney shall be submitted in original and shall be specific to the Bid submission only.</p> <p>b) In case of a Limited Company or Corporation, the Application shall be signed by an authorized person holding the Power of Attorney for signing of business proposal. A certified copy of the Power of Attorney shall accompany the Application.</p> <p>Note: Power of Attorney duly notarized and on a stamp paper of appropriate value, issued for signing the tender documents, make corrections/ modifications, to interact with the Employer and act as the contact person, shall be submitted along with Technical Bid.</p> | | | |
| b) | Scanned copy of EMD Documents. | | | |
| c) | Scanned copy of Demand Draft for Tender Fees | | | |
| d) | Letter of Transmittal For Technical Bid and Financial bid along with Declaration by the Bidder on bidder's original letter Head as per given format | | | |
| e) | <p>Bidder shall submit “Financial Information” regarding Turnover, Profit/Loss and Net Worth certificate for Last 5 (five) years ending on the financial year 2021-22 in Form-A duly certified by Statutory Auditor of the firm/company which must carry UDIN (Unique Document Identification Number) which will be verified from ICAI Portal in respect of Bidder.</p> <ul style="list-style-type: none"> • Profit / loss (after Tax): The Bidder should not have incurred any loss (profit after tax should be positive) in more than two years during last five years ending 2021-22. • Turnover: Average annual financial turnover of Bidder should be at least 50% of the estimated cost of work during the immediate last 3 consecutive financial years ending 2021-22 • Net Worth: Net worth of the Bidder should be positive during the last financial year 2021-22. The requisite certificates must be certified by statutory auditor of the firm/company. • Bidder shall attach Balance Sheet and Profit & loss Statement, duly audited by Statutory Auditor of the | | | |

| Content of Check List | | | | |
|------------------------------|--|--|--|--|
| | <p>firm for last 5 (five) years ending on the financial year 2021-22 in support of Form-A</p> <p>Note: There is no need to upload entire voluminous balance sheet. However, summarized balance sheet (Audited) and summarized Profit & Loss Account (Audited) for last 05 years shall be uploaded.</p> | | | |
| f) | <p>Solvency Certificate (40% of estimated cost excluding GST)</p> <p>The bidder contractor should not be insolvent, in receivership, bankrupt or being wound up, not have had their business activities suspended. Bank Solvency Certificate issued from a Nationalized / Scheduled Commercial Bank approved by Reserve Bank of India (RBI) should be at least 40% of the estimated cost of the work. The Certificate should be issued between the publishing of NIT & last date of submission of Bids, including extensions if any and shall be addressed to WAPCOS Limited, 76-C, Institutional Area, Sector-18, Gurugram, Haryana quoting the name of the work. The certificate shall be submitted in original and the colour / b&w copy / scanned copy shall not be accepted. The certificate should carry name, designation of the bank official, who has the authority to issue Solvency Certificate</p> <p>Note: This Certificate will be verified from the issuing authority by WAPCOS</p> | | | |
| g) | <p>Completed Similar Work Criteria:</p> <p>The bidder should have satisfactorily completed the similar types of works as mentioned below during the last seven years ending previous day of last date of submission of tender.</p> <p>i) One similar completed work costing not less than 80% of the estimated cost of work.</p> <p style="text-align: center;">Or</p> <p>ii) Two similar completed works of order value each not less than 50% of the estimated cost of work.</p> <p style="text-align: center;">Or</p> <p>iii) Three similar completed works of order value not less than 40% of the estimated cost of work.</p> <p>Note: Similar work shall mean completed any buildings with RCC framed structure including Mechanical/ Electrical/ Plumbing works during last seven years</p> <p>The value of the work done declared is to be without GST / Taxes. For the works, where the Taxes or GST is not clearly defined, the value of works shall be considered as including GST and GST @12% shall be deducted for the works completed up to 31.12.2021 and GST @18% shall be deducted for the works completed after 01.01.2022 to establish the value of work done.</p> | | | |

| Content of Check List | | | | |
|------------------------------|--|--|--|--|
| | <p>The value of executed works shall be brought to the current level by enhancing the actual value of work done at a simple rate of 7% per annum, calculated from the date of completion of last day of the month previous to the one in which applications are invited.</p> <p>The past experience in similar nature of work and also for additional experience should be supported by certificates issued by the Client's organization. In case, the works / certificates are not verified by the issuing authority, WAPCOS reserves the right to not consider for the award of works. For work experience of private sector, the completion certificates shall be supported with copies of corresponding TDS certificates. <u>In case of mismatch in value in TDS certificate & completion certificate, then value mentioned in TDS certificate will be considered during evaluation.</u></p> <p>The bidders submitting experience certificate for the works done in joint venture (JV)/consortium with other firms/companies, their proportionate experience to the extent of its share in the JV/consortium or work done by them shall only be allowed on submitting the valid proof of their share/ work done</p> <p>Note: The completion / experience certificates, along with the supporting documents, shall be got verified from the issuing authority / organizations prior to opening of Financial Bid</p> | | | |
| h) | <p>Verification of Solvency, Completion, Performance Certificates.</p> <p>Verification should be done from the official email id of issuing Authorities. The bidder will provide official e-mail, Landline number of the Issuing Authorities in prescribed Form-C with undertaking. Bidder will ensure the email ids and landline are in working condition.</p> <p>If Solvency Certificate, completion, performance certificates are not verified by the issuing authority within 5 working days, then it will not be considered for technical evaluation.</p> | | | |
| i) | <p>Bid Capacity as prescribed in Form-D.</p> <p>The bidder should possess the bidding capacity as calculated by the specified formula. The formula generally used is:</p> <p>Available bid capacity = A x 1.5 x N – B, where A = Maximum value of engineering (Civil/ Electrical/ Mechanical as relevant to work being procured) works executed in any one year during the last five years (updated</p> | | | |

| Content of Check List | | | | |
|------------------------------|--|--|--|--|
| | <p>at the current price level), taking into account the completed as well as works in progress. N = Number of years prescribed for completion of the work in question. B = Value (updated at the current price level) of the existing commitments and ongoing works to be completed in the next 'N' years.</p> <p>NOTE: The bidder shall furnish statements showing the value of existing commitments and on-going works as well as stipulated period of completion remaining for each of the works separately.</p> <p>The value of executed works shall be brought to the current level by enhancing the actual value of work done at a simple rate of 7% per annum, calculated from the date of completion of last day of the month previous to the one in which applications are invited.</p> | | | |
| j) | <p>EPF Registration: The agency should have EPF registration.</p> | | | |
| k) | <p>GST Registration & PAN:</p> <p>Bidder shall submit valid GST registration certificate for the state where work is to be executed and PAN Card. If not registered till date of submission of bid, bidder will give undertaking on bidder letter head stating that they will get registered in GST as per Govt. norms before submitting of 1st bill of executed works.</p> | | | |
| l) | <p>Indian Registered Company:</p> <p>The bidder should be an Indian Registered Company under Companies Act 1956/ Proprietorship Firm/ Partnership Firm. Joint ventures are not accepted. Copy of Certificate of Incorporation/ Registration/ Partnership Deed Registration or any other relevant document, as applicable, should be submitted along with a copy of address proof.</p> <p>NOTE: Proprietor firms shall submit registration details or shall submit the copy of relevant page of Pass book for the Current Account in the name of Proprietor Firm.</p> | | | |
| m) | <p>Structure & Organization:</p> <p>The bidder will submit Name, address, details of the organization, Name(s) of the Owner/partners/promoters and Directors of the firm/ company as prescribed in Form-E.</p> | | | |
| n) | <p>Undertaking for Manpower Deployment:</p> <p>The bidder will submit “Undertaking for Manpower Deployment” as prescribed in Form -F</p> | | | |

| Content of Check List | | | | |
|-----------------------|--|--|--|--|
| o) | Non - Conviction Certificate: The bidder will submit the undertaking regarding “ Non – Conviction Certificate ” as prescribed in Form-G . | | | |
| p) | No Deviation Certificate: The bidder will submit ‘ No Deviation Certificate ’ as prescribed in Form-H . | | | |
| q) | Undertaking regarding Blacklisting / Non Debarment The bidder will submit the “Undertaking regarding Blacklisting / Non Debarment” as prescribed in Form-I . | | | |
| r) | Undertaking regarding Restriction under Rule 144(XI) of the General Finance Rules (GFRs) 2017 The bidder will submit the “Undertaking regarding Restriction under Rule 144(XI) of the General Finance Rules (GFRs) 2017” as prescribed in Form –J . | | | |
| s) | Preference to Make in India: The bidder shall submit undertaking indicating percentage of local content used during the execution of work as per the order of Public Procurement (Preference to Make in India) as prescribed in Form-K | | | |
| t) | Letter for Integrity and Integrity Agreement The bidder will submit Consent Letter along with Integrity Agreement on appropriate value of Stamp Paper to execute the Integrity Pact as prescribed in Form-L | | | |
| u) | Performance of Bidder in EMRS Projects, The bidder will submit Performance in EMRS projects, if working in EMRS project under NESTS with any PSUs of Govt. of India, as prescribed in Form-M . Note: This Certificate will be verified from the issuing authority by WAPCOS | | | |
| v) | Understanding The Project Site The bidder will submit the “Understanding The Project Site” as prescribed in Form –N . | | | |

4.0 OFFLINE SUBMISSIONS OF DOCUMENTS

The Bidder shall submit following Document offline in separate envelope clearly labeled as “OFFLINE DOCUMENTS” for the Work (Write Name of Work/Project as mentioned in NIT) along with Details of Bidders Address, Phone, E-mail on Envelope.

- Original Tender Fees
- Original Earnest Money Deposit/ Bid Security
- Original Solvency Certificate
- Original Form-A Depicting Gross Annual Turnover, Profit / loss and Net worth duly signed by Statutory Auditor with UDIN number.
- Original Integrity Agreement on stamp paper with format enclosed with tender

- Original Form-K Depicting percentage of local content used during the execution of work duly signed by Statutory Auditor with UDIN number

NOTE:- The above offline documents shall be submitted by bidder on WAPCOS address as per date & time mentioned in NIT, otherwise bids will be rejected.

5.0 CONTENTS OF FINANCIAL BID

The Financial Bid should be uploaded online before last date & time of submission of Tender Document.

Quoted amount by the Bidder shall be firm during the performance of the Contract. Quoted amount by the Bidder with any condition shall not be accepted and same is liable to be rejected. Quoted amount by the Bidder shall include all Materials, Tools & Plant, labour, supervision, profit; other levies together with all general risks, liabilities and obligations set out or implied in the contract, applicable Labour Cess, cost of insurance to this contract, all applicable tax liabilities like Income Tax & Surcharges, etc. Any other taxes /cess as per Government directives shall be deducted from each bill paid to the Contractor, from time to time. GST shall be payable extra as per prevailing rates.

The Contractor shall submit e-invoice / Tax Invoice (as applicable for the bidder's Firms) to WAPCOS showing (i) Basic amount (ii) GST amount separately in each bill. It is mandatory to bidders to deposit GST within time limit framed by Govt. of India, if applicable. The Goods and Services Tax (GST), shall be reimbursed to the Agency only after uploading of bills by Contractor on GST Portal "to avail Input benefit of GST".

The WAPCOS shall be performing all its duties of deduction of TDS and other deduction on payment made to the contractor as per applicable legislation in force on the date of submission of bid or to be newly/amended introduced during the execution of the Contract.

6.0 OPENING OF FINANCIAL BID

The financial bids of the technically qualified bidders shall be opened at the notified date & time. Final selection of the bidder will be made based on the least cost method.

7.0 SIGNING OF THE CONTRACT

The letter of Award will be issued to the successful bidder by WAPCOS which will be duly signed & stamped by the successful bidder as token of unequivocal acceptance and confirmation within 5 working days. Subsequently, successful bidder shall submit the Performance Security of required value within the specified time period. Thereafter, on a date and time mutually agreed upon, the successful Bidder or his authorized representative shall attend the office for signing of the Contract Agreement.

Failure on the part of the successful Bidder to comply with the above requirements will constitute sufficient grounds for the annulment of the Award and forfeiture of the Bid Security.

SECTION – III

FORMS

| | |
|--------|--|
| | LETTER OF TRANSMITTAL FOR TECHNICAL BID AND FINANCIAL BID ALONG WITH DECLARATION |
| FORM-A | FINANCIAL INFORMATION |
| FORM-B | SOLVENCY CERTIFICATE |
| FORM-C | CORRESPONDENCE DETAILS OF ISSUING AUTHORITY |
| FORM-D | BID CAPACITY |
| FORM-E | STRUCTURE & ORGANISATION |
| FORM-F | UNDERTAKING FOR MANPOWER DEPLOYMENT |
| FORM-G | NO CONVICTION CERTIFICATE |
| FORM-H | NO DEVIATION CERTIFICATE |
| FORM-I | UNDERTAKING REGARDING BLACKLISTING / NON DEBARMENT |
| FORM-J | UNDERTAKING FOR RESTRICTION UNDER RULE 144(XI) OF GFRs |
| FORM-K | PREFERENCE TO MAKE IN INDIA |
| FORM-L | LETTER FOR INTEGRITY AND INTEGRITY AGREEMENT |
| FORM-M | PERFORMANCE OF BIDDER IN EMRS PROJECTS |
| FORM-N | UNDERSTANDING THE PROJECT SITE |

(TO BE SUBMITTED ON BIDDER ORIGINAL LETTER HEAD)

LETTER OF TRANSMITTAL FOR TECHNICAL BID

To,
Sr. General Manager
Construction Management Unit-I
1st floor, Plot no. 148,
Sector- 44, Gurugram, Haryana-122003
Email: buildings@wapcos.co.in
Contact No. +91124-4488018

Subject: Submission of Bids for Construction of Eklavya Model Residential School at Jaldega, District Simdega, Jharkhand

Sir,

Having examined the details given in tender document for the above work, I/we hereby submit the relevant information.

- i. I / We acknowledge that the WAPCOS will be relying on the information provided in the Bid and the documents accompanying the Bid & detailed provided in the enclosed “Forms” for selection of the Contractor for the aforesaid Project, and we certify that all information provided in the Bid are true and correct; nothing has been omitted which renders such information misleading; and all documents accompanying the Bid are true copies of their respective originals.
- ii. I/we have furnished all information and details necessary for eligibility and have no further pertinent information to supply.
- iii. I/we submit the requisite Solvency Certificate, Completion Certificates, Financial Information’s and authorize WAPCOS Ltd. to approach the Issuing Authority to confirm the correctness thereof. I/we also authorize WAPCOS Ltd. to approach individuals, employers, firms and corporation to verify our competence and general reputation.
- iv. I/ We acknowledge the right of the Authority to reject our Bid without assigning any reason or otherwise and hereby waive, to the fullest extent permitted by applicable law, our right to challenge the same on any account whatsoever.
- v. I/we submit the following certificates in support of our suitability, technical knowledge and capability for having successfully completed the following eligible similar works:

| Name of work | Certificate from |
|--------------|------------------|
| | |
| | |
| | |

Date:

(Signature, Name, Designation
of the Authorized signatory with Seal)

Place:

(TO BE SUBMITTED ON BIDDER ORIGINAL LETTER HEAD)

LETTER OF TRANSMITTAL FOR FINANCIAL BID

Dated:

To
Sr. General Manager
Construction Management Unit-I
1st floor, Plot no. 148,
Sector- 44, Gurugram, Haryana-122003
Email: buildings@wapcos.co.in
Contact No. +91124-4488018

Sub: Financial Bid for the Construction of Eklavya Model Residential School at Jaldega, District Simdega, Jharkhand

Dear Sir,

With reference to this Tender Document, I/we, having examined the Bidding Documents and understood their contents, hereby submit my/our Bid for the aforesaid Project. The Bid is unconditional and unqualified.

1. The Cost has been quoted by me/us for bid after taking into consideration all the terms and conditions stated in the Tender Document, our own estimates of costs and after a careful assessment of the site and all own the conditions that may affect the project cost and implementation of the project.
2. I / We shall keep this offer valid as period specified in the NIT.
3. I / We hereby submit our FINANCIAL BID and Offer Cost as filled in BoQ excel sheet "BoQ1" for undertaking the aforesaid Project in accordance with the Bidding Documents and the Agreement.

Yours faithfully,

Date:

(Signature, name and designation
of the Authorized signatory)

Place:

Name and seal of Bidder

(TO BE SUBMITTED ON BIDDER ORIGINAL LETTER HEAD)

DECLARATION BY THE BIDDER

This is to certify that We, M/s, in submission of this offer confirm that:-

We have inspected the site of work and have made myself/ourselves fully acquainted with local conditions in and around the site of work. We have carefully gone through each & every section of the tender document for the work Construction of Eklavya Model Residential School at Jaldega, District Simdega, Jharkhand”.

1. Our tender is offered taking due consideration of all factors mentioned in tender documents.
2. We promise to abide by all the stipulations of the Contract documents and carry out and complete the work to the satisfaction of the Employer/ Principal Employer.
3. We also agree to procure Plants and Machineries at our cost required for the work. We also submit that we have Organizational Structure comprising adequate Technical Personnel in the line of requirement. We also agree to accomplish the job entrusted to us in the stipulated time laid out in document except situations not under our control.
4. We have not made any misleading or false representation in the forms, statement and attachments in proof of the qualification requirements;
5. We do not have records of poor performance such as abandoning the work, not properly completing the Contract, inordinate delays in completion or financial failures etc.
6. We have submitted all the supporting documents and furnished the relevant details as per prescribed format.
7. We are financially sound and have not applied or be under corporate debt restructuring.
8. List of Similar Works satisfying Qualification Criterion as indicated hereinafter, does not include any work which has been carried out by us through a Subcontractor on a back-to-back basis.
9. The Cost has been quoted by me/us for bid after taking into consideration all the terms and conditions stated in the Tender Document, our own estimates of costs and after a careful assessment of the site and all own the conditions that may affect the project cost and implementation of the project.
10. I / We shall keep this offer valid as period specified in the NIT.
11. I / We hereby submit our FINANCIAL BID and Offer Cost for undertaking the aforesaid Project in accordance with the Bidding Documents and the Agreement.
12. In the event of my/ our being declared as the Selected Bidder, I/we agree to enter into a Agreement in accordance with the format of Contract Agreement. We agree not to seek any changes in the aforesaid format of Contract Agreement and agree to abide by the same.

Certificate:

It is certified that the information given in the enclosed bid are correct. It is also certified that I/we shall be liable to be debarred, disqualified / cancellation of enlistment in case any information furnished by me/us found to be incorrect.

Date:

**(Signature, Name, Designation
of the Authorized signatory with Seal)**

Place:

[TO BE SUBMITTED ON ORIGINAL LETTER HEAD OF STATUTORY AUDITOR OF BIDDER]

FORM-A: FINANCIAL INFORMATION

| Years | Gross Annual turnover | Profit/Loss (After Tax) | Net worth |
|--------------|------------------------------|--------------------------------|------------------|
| 2017-2018 | | | |
| 2018-2019 | | | |
| 2019-2020 | | | |
| 2020-2021 | | | |
| 2021-2022 | | | |

Above Details are being furnished as per the figures in balance sheet for the last five years in respect of M/s(Name & address of firm of bidder), as submitted by the firm to the Income Tax Department.

Date:

(Signature of Statutory Auditor with Seal)

UDIN No. :

Place:

[TO BE SUBMITTED ON ORIGINAL LETTER HEAD OF ISSUING BANK]

FORM- B: SOLVENCY CERTIFICATE

To
WAPCOS Limited,
76-C, Institutional Area,
Sector-18, Gurugram, Haryana

Name of Work: **Construction of Eklavya Model Residential School at Jaldega, District Simdega, Jharkhand**

This is certify that to the best of our knowledge and information that M/s(name of bidder & address).....
.....
.....
.....
.....

(Signature for The Bank)

(TO BE SUBMITTED ON BIDDER ORIGINAL LETTER HEAD)

FORM-C: CORRESPONDENCE DETAILS OF ISSUING AUTHORITY

Solvency Certificate/ Completion Certificate / Performance Certificate

Name of Work: Construction of Eklavya Model Residential School at Jaldega, District Simdega, Jharkhand

A. Solvency Certificate

| Present address of the Issuing Branch | Official Email Id | Landline no | Other Contact no. |
|---------------------------------------|-------------------|-------------|-------------------|
| | | | |

B. Completion Certificate

| Present address of the Issuing Authority | Official Email Id | Landline no | Other Contact no. |
|--|-------------------|-------------|-------------------|
| | | | |

C. Performance Certificate for EMRS Works

| Present address of the Issuing Authority | Official Email Id | Landline no | Other Contact no. |
|--|-------------------|-------------|-------------------|
| | | | |

This is to certify that above information is correct and is gathered from the Issuing Authorities by us for the verification of concerned documents. We understand that if the documents is not verified by the issuing authority within 5 working days, then our bid is liable to be rejected.

Date:

**(Signature, Name, Designation
of the Authorized signatory with Seal)**

Place:

(TO BE SUBMITTED ON BIDDER ORIGINAL LETTER HEAD)

FORM- D: BID CAPACITY

Name of Work: Construction of Eklavya Model Residential School at Jaldega, District Simdega, Jharkhand

Available bid capacity = $A \times 1.5 \times N - B$

Where,

A = Maximum value of engineering (Civil/ Electrical/ Mechanical as relevant to work being procured) works executed in any one year during the last five years (updated at the current price level), taking into account the completed as well as works in progress.

N = Number of years prescribed for completion of the work in question.

B = Value (updated at the current price level) of the existing commitments and ongoing works to be completed in the next 'N' years.

Existing Commitments & on-going works details:

| Description of work | Location | Contract no. | Name of address of Client | Value of Contract (Rs. Cr.) | Stipulated period of completion | Value of remaining work (Rs. cr.) | Anticipated date of completion |
|---------------------|----------|--------------|---------------------------|-----------------------------|---------------------------------|-----------------------------------|--------------------------------|
| | | | | | | | |
| | | | | | | | |
| | | | | | | | |
| | | | | | | | |

NOTE:

The bidder shall furnish statements showing the value of existing commitments and on-going works as well as stipulated period of completion remaining for each of the works separately.

The value of executed works shall be brought to the current level by enhancing the actual value of work done at a simple rate of 7% per annum, calculated from the date of completion of last day of the month previous to the one in which applications are invited.

Date:

**(Signature, Name, Designation
of the Authorized signatory with Seal)**

Place:

(TO BE SUBMITTED ON BIDDER ORIGINAL LETTER HEAD)

FORM- E: STRUCTURE & ORGANISATION

Name of Work: Construction of Eklavya Model Residential School at Jaldega, District Simdega, Jharkhand

| S.No. | Particulars | Details |
|--------------|---|---|
| 1. | Name & Registered Address of the Bidder | |
| 2. | Address and Email on which Correspondence will be made during Tendering & after Award of Work | |
| 3. | Telephone no./Telex no./Fax no. | |
| 4. | Legal status of the Bidder (attach copies of original document defining the legal status) (a) A Proprietary Firm (b) A Partnership Firm (c) A Limited Company or Corporation (d) A Company registered under company's Act 1956/2013 | |
| 5. | Particulars of Registration with various Government Bodies (Attach attested photocopy) Organization/Place of Registration 1. 2. 3. | Registration No. 1. 2. 3. |
| 6. | Names and Titles of Directors with designation as per Legal Status of Company | |
| 7. | Designation of Senior Level Officers authorized to act for this work | |
| 8. | Any other information considered necessary but not included above. | |

Date:

**(Signature, Name, Designation
of the Authorized signatory with Seal)**

Place:

(TO BE SUBMITTED ON BIDDER ORIGINAL LETTER HEAD)

FORM- F: - UNDERTAKING FOR MANPOWER DEPLOYMENT

Name of Work Construction of Eklavya Model Residential School at Jaldega, District Simdega, Jharkhand

This is to certify that We, M/s,
in submission of this offer confirm that:-

- I. Our tender is offered taking due consideration of all factors including site requirements information and conditions stated in the detailed Instructions to Bidders to execute the work up to the standards as laid out in Employer's Requirements and other sections of Tender Document.
- II. We agree to employ the number of technical staff during the execution of this work as defined in the tender document. We shall deploy additional manpower as deemed fit and required to complete the project within stipulated completion period, without any additional cost to the Employer.
- III. WAPCOS shall have full power and without giving any reason to us, immediately to get removed any representative, staff and workmen or employees on account of misconduct negligence or incompetence or whose continued employment may in his opinion be undesirable. We shall not claim any compensation on this account.
- IV. In case we fail to deploy the technical staff as mentioned in the tender document, we shall be liable to pay recovery for each month of default as mentioned in Tender Documents . The details of Deployment of Technical Staff will be submitted with each Bill duly certified by The Project Manager, WAPCOS. We shall not raise any objection if deduction is made for the same from Running Bills.

Date:

**(Signature, Name, Designation
of the Authorized signatory with Seal)**

Place:

(TO BE SUBMITTED ON BIDDER ORIGINAL LETTER HEAD)

FORM-G: NO-CONVICTION CERTIFICATE

Name of Work: Construction of Eklavya Model Residential School at Jaldega, District Simdega, Jharkhand

This is to certify that _____ (Name of the organization), having registered office at _____ (Address of the registered office) has never been convicted by any Central / State Government Department or Court of law anywhere in the country.

This is also to certify that we are not involved in any form of Corrupt and Fraudulent Practices in past and will never be involved in future.

Date:

**(Signature, Name, Designation
of the Authorized signatory with Seal)**

Place:

(TO BE SUBMITTED ON BIDDER ORIGINAL LETTER HEAD)

FORM-H: NO DEVIATION CERTIFICATE

Name of Work: Construction of Eklavya Model Residential School at Jaldega, District Simdega, Jharkhand

This is to confirm that as per Tender conditions we have visited site before submission of our Offer and noted the job content and site condition etc. We also confirm that we have not changed/modified the above tender document and in case of observance of the same at any stage it shall be treated as null and void.

We hereby also confirm that we have not taken any deviation from Tender Clause together with other reference as enumerated in the above referred Notice Inviting Tender and we hereby convey our unconditional acceptance to all terms & conditions as stipulated in the Tender Document.

In the event of observance of any deviation in any part of our offer at a later date whether implicit or explicit, the deviations shall stand null and void.

Date:

**(Signature, Name, Designation
of the Authorized signatory with Seal)**

Place:

(TO BE SUBMITTED ON BIDDER ORIGINAL LETTER HEAD)

FORM-I: UNDERTAKING REGARDING BLACKLISTING / NON DEBARMENT

Name of Work: Construction of Eklavya Model Residential School at Jaldega, District Simdega, Jharkhand

This is to certify that we have taken the cognizance of Blacklisting Policy of WAPCOS Ltd. Further, we hereby Confirm and declare that we, M/s _____, is not blacklisted/De-registered/debarred by any Government Department/Public Sector Undertaking /Private Sector/ or any other agency for which we have Executed / Undertaken the works/ Services during the last 5 Years.

Date:

**(Signature, Name, Designation
of the Authorized signatory with Seal)**

Place:

(TO BE SUBMITTED ON BIDDER ORIGINAL LETTER HEAD)

**FORM-J: UNDERTAKING FOR RULE 144 (XI) IN THE GENERAL FINANCIAL
RULES-2017**

**Name of Work: Construction of Eklavya Model Residential School at Jaldega, District Simdega,
Jharkhand**

I / we(Name of the Firm)
well aware about the Restrictions under RULE 144 (XI) In General Financial Rules (GFR), 2017 on
procurement from country which shares a land border with India.. I/ we hereby certify that we are eligible
to participate in the tender as per Rule 144 (xi) In The General Financial Rules (GFR), 2017

Date:

**(Signature, Name, Designation
of the Authorized signatory with Seal)**

Place:

[TO BE SUBMITTED ON ORIGINAL LETTER HEAD OF STATUTORY AUDITOR
OF BIDDER]

FORM-K: UNDERTAKING REGARDING PERCENTAGE OF LOCAL CONTENT

We, , a Chartered Accountant firm having our registered office address..... hereby state that, we are Statutory Auditor of the Company M/s..... (CIN :).

The Bidder is bidding for the “..... (Name of work)

We have understood the provisions of Public Procurement (Preference to make in India) Local content Policy against WAPCOS Tender NIT No. Date -.....

We on the basis of the bidder’s representation received, hereby confirm that, offer is achieving the minimum local content target as per of above Policy shall be **50%**.

Date:

(Signature of Statutory Auditor with Seal)

UDIN No. :

Place:

[TO BE SUBMITTED ON BIDDER'S ORIGINAL LETTER HEAD]

FORM-L: LETTER FOR INTEGRITY AND INTEGRITY AGREEMENT

To,
WAPCOS Limited,
76-C, Sector 18,
Institutional Area
Gurgaon, Haryana-122015

Sub: Integrity Pact for Construction of Eklavya Model Residential School at Jaldega, District Simdega, Jharkhand

Dear Sir,

I/We acknowledge that WAPCOS is committed to follow the principles thereof as enumerated in the Integrity Agreement enclosed with the tender/bid document at **Appendix-I**.

I/We agree that the Notice Inviting Tender (NIT) is an invitation to offer made on the condition that I/We am/are signing the enclosed integrity Agreement, which is an integral part of tender documents, failing which I/We will stand disqualified from the tendering process. I/We acknowledge that **THE MAKING OF THE BID SHALL BE REGARDED AS AN UNCONDITIONAL AND ABSOLUTE ACCEPTANCE** of this condition of the NIT.

I/We confirm acceptance and compliance with the Integrity Agreement in letter and spirit and further agree that execution of the said Integrity Agreement shall be separate and distinct from the main contract, which will come into existence when tender/bid is finally accepted by WAPCOS. I/We acknowledge and accept the duration of the Integrity Agreement, which shall be in the line with Article 1 of the enclosed Integrity Agreement.

I/We acknowledge that in the event of my/our failure to sign and accept the Integrity Agreement, while submitting the tender/bid, WAPCOS shall have unqualified, absolute and unfettered right to disqualify the tenderer/bidder and reject the tender/bid in accordance with terms and conditions of the tender/bid.

Date:

**(Signature, Name, Designation
of the Authorized signatory with Seal)**

Place:

INTEGRITY AGREEMENT

[Will be submitted on non-judicial Stamp paper of Rs.100 duly attested by notary/Magistrate]

This Integrity Agreement is made at on this day of 20.....

BETWEEN

WAPCOS Limited, New Delhi (Hereinafter referred as the ‘EMPLOYER’, which expression shall unless repugnant to the meaning or context hereof include its successors and permitted assigns)

AND

..... (Name and Address of the Individual/firm/Company) through (Hereinafter referred to as the (Details of duly authorized signatory)

“Bidder/Contractor” and which expression shall unless repugnant to the meaning or context hereof include its successors and permitted assigns)

PREAMBLE

‘The Employer’ intends to award, under laid down organizational procedures, contract/ s for _____, ‘The Employer’ values full compliance with all relevant laws of the land, rules, regulations, economic use of resources and of fairness/ transparency in its relations with its Bidder(s) and/ or Contractor(s).

In order to achieve these goals, the Employer shall appoint Independent External Monitors (IEMs) who shall monitor the tender process and the execution of the contract for compliance with the principles mentioned above.

Section 1 - Commitments of the ‘The Employer’

- 1) ‘The Employer’ commits itself to take all measures necessary to prevent corruption and to observe the following principles: -
 - (a) No employee of the Employer, personally or through family members, shall in connection with the tender for, or the execution of a contract, demand, take a promise for or accept, for self or third person, any material or immaterial benefit which the person is not legally entitled to.
 - (b) The Employer shall, during the tender process, treat all Bidder(s) with equity and reason. The Employer shall in particular, before and during the tender process, provide to all Bidder(s) the same information and shall not provide to any Bidder(s) confidential/ additional information through which the Bidder(s) could obtain an advantage in relation to the tender process or the contract execution.
 - (c) The Employer shall exclude from the process all known prejudiced persons.
- 2) If the Employer obtains information on the conduct of any of its employees, which is a criminal offence under the IPC/ PC Act, or if there be a substantive suspicion in this regard, the Employer shall inform the Chief Vigilance Officer and, in addition, can initiate disciplinary actions.

Section 2 - Commitments of the ‘Bidder/ Contractor’

- 1) The ‘Bidder/ Contractor’ commit themselves to take all measures necessary to prevent corruption. The ‘Bidder/ Contractor’ commit themselves to observe the following principles during participation in the tender process and during the contract execution.
 - a) The ‘Bidder/ Contractor’ shall not, directly or through any other person or firm, offer, promise, or give to any of the Employer’s employees involved in the tender process or the execution of

the contract or to any third person any material or other benefit which he is not legally entitled to, in order to obtain in exchange any advantage of any kind whatsoever during the tender process or during the execution of the contract.

- b) The 'Bidder/ Contractor' shall not enter with other Bidders into any undisclosed agreement or understanding, whether formal or informal. This applies in particular to prices, specifications, certifications, subsidiary contracts, submission or non-submission of bids or any other actions to restrict competitiveness or to introduce cartelisation in the tender process.
 - c) The 'Bidder/ Contractor' shall not commit any offence under the relevant IPC/ PC Act; further, the 'Bidder/ Contractor' shall not use improperly, for purposes of competition or personal gain, or pass on to others, any information or document provided by the Employer as part of the business relationship, regarding plans, technical proposals, and business details, including information contained or transmitted electronically.
 - d) The 'Bidder/ Contractor' of foreign origin shall disclose the name and address of the Agents/ representatives in India if any. Similarly, the Bidder/ Contractors of Indian Nationality shall furnish the name and address of the foreign Employers, if any. Further details as mentioned in the "Guidelines on Indian Agents of Foreign Suppliers" shall be disclosed by the Bidder/ Contractor. Further, as mentioned in the Guidelines, all the payments made to the Indian agent/ representative have to be in Indian Rupees only. Copy of the "Guidelines on Indian Agents of Foreign Suppliers" is placed in Appendix to this agreement.
 - e) The 'Bidder/ Contractor' shall, when presenting their bid, disclose any and all payments made, is committed to, or intends to make to agents, brokers, or any other intermediaries in connection with the award of the contract.
 - f) Bidder/ Contractor who have signed the Integrity Pact shall not approach the Courts while representing the matter to IEMs and shall wait for their decision in the matter.
- 2) The 'Bidder/ Contractor' shall not instigate third persons to commit offences outlined above or be an accessory to such offences.

Section 3 - Disqualification from tender process and exclusion from future contracts

If the 'Bidder/ Contractor', before award or during execution, has committed a transgression through a violation of Section 2, above or in any other form such as to put their reliability or credibility in question, the Employer is entitled to disqualify the 'Bidder/ Contractor' from the tender process or take action as per the procedure mentioned in the "Guidelines on Banning of business dealings".

Section 4 - Compensation for Damages

- 1) If the Employer has disqualified the 'Bidder/ Contractor' from the tender process prior to the award according to Section 3, the Employer is entitled to demand and recover from 'Bidder/ Contractor' the damages equivalent to Earnest Money Deposit/ Bid Security.
- 2) If the Employer has terminated the contract according to Section 3, or if the Employer is entitled to terminate the contract according to Section 3, the Employer shall be entitled to demand and recover from the contractor liquidated damages of the contract value or the amount equivalent to Performance Bank Guarantee.

Section 5 - Previous transgression

- 1) Bidder declares that no previous transgressions occurred in the last three years with any other Company in any country conforming to the anti-corruption approach or with any Public Sector Enterprise in India that could justify his exclusion from the tender process.
- 2) If Bidder makes an incorrect statement on this subject, he can be disqualified from the tender process, or action can be taken as per the procedure mentioned in "Guidelines on Banning of business dealings".

Section 6 - Equal treatment of all Bidders/ Contractors/ Subcontractors

- 1) In the case of Sub-contracting, the Principal Contractor shall take responsibility for the adoption of the Integrity Pact by the Sub-contractor.

- 2) The Employer shall enter into agreements with identical conditions as this one with all Bidders and Contractors.
- 3) The Employer shall disqualify from the tender process all bidders who do not sign this Pact or violate its provisions.

Section 7 - Criminal charges against violating Bidder(s)/ Contractor(s)/ Subcontractor(s)

If the Employer obtains knowledge of the conduct of a Bidder, Contractor or Subcontractor, or of an employee or a representative or an associate of a Bidder, Contractor or Subcontractor which constitutes corruption, or if the Employer has substantive suspicion in this regard, the Employer shall inform the same to the Chief Vigilance Officer.

Section 8 - Independent External Monitor

- 1) The Employer appoints a competent and credible Independent External Monitor for this Pact after approval by Central Vigilance Commission. The task of the Monitor is to review independently and objectively whether and to what extent the parties comply with the obligations under this agreement.
- 2) The Monitor is not subject to instructions by the representatives of the parties and performs his functions neutrally and independently. The Monitor would have access to all Contract documents whenever required. It shall be obligatory for him/ her to treat the information and documents of the Bidders/ Contractors as confidential. He/ she reports to the Head of the Organisation.
- 3) The Bidder(s)/ Contractor(s) accepts that the Monitor has the right to access without restriction to all Project documentation of the Employer, including that provided by the contractor. The Contractor shall also grant the Monitor, upon his request and demonstration of a valid interest, unrestricted and unconditional access to their project documentation. The same is applicable to Sub-contractors.
- 4) The Monitor is under contractual obligation to treat the information and documents of the Bidder/ Contractor(s)/ Sub-contractor(s) with confidentiality. The Monitor has also signed declarations on 'Non-Disclosure of Confidential Information and of 'Absence of Conflict of Interest'. In case of any conflict of interest arising at a later date, the IEM shall inform the Head of the Organisation and recuse himself/ herself from that case.
- 5) The Employer shall provide to the Monitor sufficient information about all meetings among the parties related to the Project provided such meetings could have an impact on the contractual relations between the Employer and the contractor. The parties offer the Monitor the option to participate in such meetings.
- 6) As soon as the Monitor notices, or believes to have noticed, a violation of this agreement, he shall so inform the Management of the Employer and request the Management to discontinue or take corrective action or to take other relevant action. The monitor can, in this regard, submit non-binding recommendations. Beyond this, the Monitor has no right to demand from the parties that they act in a specific manner, refrain from action, or tolerate action.
- 7) The Monitor shall submit a written report to the Head of the Organisation within 8 to 10 weeks from the date of reference or intimation to him by the Employer and, should the occasion arise, submit proposals for correcting problematic situations.
- 8) If the Monitor has reported to the Head of the Organisation, a substantiated suspicion of an offence under relevant IPC/ PC Act, and Head of the Organisation has not, within the reasonable time, taken visible action to proceed against such offence or reported it to the Chief Vigilance Officer, the Monitor may also transmit this information directly to the Central Vigilance Commissioner.
- 9) The word 'Monitor' would include both singular and plural.

Section 9 - Pact Duration

This Pact begins when both parties have legally signed it. It expires for the contractor 12 months after the last payment under the contract and for all other Bidders 6 months after the contract has been awarded. Any violation of the same would entail disqualification of the bidders and exclusion from future business dealings.

If any claim is made/ lodged during this time, the same shall be binding and continue to be valid despite the lapse of this pact as specified above unless it is discharged/ determined by the Head of the Organization.

Section 10 - Other provisions

- 1) This agreement is subject to Indian Law. The place of performance and jurisdiction is the Registered Office of the Employer, i.e., New Delhi.
- 2) Changes and supplements, as well as termination notices, need to be made in writing. Side agreements have not been made.
- 3) If the contractor is a partnership or a consortium, this agreement must be signed by all partners or consortium members.
- 4) Should one or several provisions of this agreement turn out to be invalid, the remainder of this agreement remains valid. In this case, the parties shall strive to come to an agreement with their original intentions.
- 5) Issues like Warranty/ Guarantee etc. shall be outside the purview of IEMs.
- 6) In the event of any contradiction between the Integrity Pact and its Appendix, the Clause in the Integrity Pact shall prevail.
- 7) For and on behalf of the Employer

SIGNED, SEALED AND DELIVERED

For and on behalf of the WAPCOS

For and on behalf of the Contractor

NAME _____
DESIGNATION _____

NAME _____
DESIGNATION _____

In the presence of witness:

In the presence of Witness

_1 _____
2 _____

_1 _____
2 _____

[To be submitted by Bidder on their Original Letter Head]

FORM-M: PERFORMANCE OF BIDDER IN EMRS PROJECTS

This is to certify that our firm is also engaged for the following works of EMRS under NESTS as detailed below

| SN | Name of Project | Location & state | Name of PSU | Project Cost | Date of Start | Stipulated Time of Completion | On going / completed |
|----|-----------------|------------------|-------------|--------------|---------------|-------------------------------|----------------------|
| | | | | | | | |
| | | | | | | | |

Date:

(Signature, name and designation of the Authorized signatory)

Place:

Name and seal of Bidder

NOTE:

1. If bidder is not engaged in works of EMRS under NESTS, then bidder will submit above information as NIL and their bid will be considered during evaluation
2. If bidder is engaged in different works of EMRS under NESTS with any PSUs, then then it is mandatory to disclose the same in above format. In this condition, bidder will submit format FORM G(a) regarding performance of the bidder for on-going/completed EMRS Works duly certified from the each concerned PSUs for each EMRS works under NESTS. The same will be verified from the concerned PSU. If the performance of the bidder is not satisfactory in any parameter mentioned in Form- G(a), then his bid will not be considered for evaluation.

[To be submitted by Bidders on Letter Head of Concerned PSU]

FORM-M(a): PERFORMRANCE OF BIDDER IN EMRS PROJECT

Performance Certificate

| | | | |
|----|--|--------------|------------------|
| 1. | Name of work / project & Location | | |
| 2. | NIT Cost excluding GST | Rs. | |
| 2. | Awarded Cost excluding GST | Rs. | |
| 3. | Date of Start | | |
| 4. | Stipulated date of completion | | |
| 5. | Physical Progress of work up to 31-12-2022 | | |
| 6. | Extended date of completion | | |
| 7 | Any Litigation during execution of project | | |
| 8. | Performance Report : | | |
| | a) Quality of work | Satisfactory | Not satisfactory |
| | b) Progress of work | Satisfactory | Not satisfactory |
| | c) Technical Proficiency | Satisfactory | Not satisfactory |
| | d) Resourcefulness | Satisfactory | Not satisfactory |

**(Signature, name and designation
of the Nodal officer of PSU for EMRS Works)**

Official Email :-
Official Contact Number:
Address of PSU :

[TO BE SUBMITTED BY BIDDER ON THEIR ORIGINAL LETTER HEAD]

FORM-N: UNDERSTANDING THE PROJECT SITE

Name of Work: Construction of Eklavya Model Residential School at Jaldega, District Simdega, Jharkhand

I/we hereby certify that I/we have examined & inspected the site & its surrounding satisfactorily, where the project is to be executed. I/ We are well aware about the following

- Location of the land demarcated for the execution of work and approach/ accessibility to the site.
- Availability of all construction material required for the execution of work.
- Location of the proposed buildings and its allied works on demarcated land.
- Sources from where electric connection is to be taken by contractor at the time of mobilization or other arrangements for electricity is to be made.
- Sources from where suitable water for construction is to be arranged.
- Site clearance and location of matured trees.
- Awareness about the surrounding local conditions, villagers etc.
- Topography, contouring and any other relevant feature like Pond, nallah etc. of the land where the project is to be executed.
- Nature of the ground & sub-soil of the site and accessibility to the site.
- Location of local electrical supply line and other relevant services
- Hindrances / dispute, if any, which may arise during the execution of work

I / We hereby submit our BID considering above all facts gathered during site visit and each & every aspect have been considered in the Quoted percentage Rates / price.

Date:

**(Signature, Name, Designation
of the Authorized signatory with Seal)**

Place:

SECTION – IV

GENERAL CONDITIONS OF CONTRACT

SECTION – IV

GENERAL CONDITIONS TO CONTRACT

1.0 GENERAL RULES AND DIRECTIONS

| | | |
|--|----|---|
| General Rules & Directions | 1. | <p>The work proposed for execution by contract will be notified in a form of invitation to tender by publication in website.</p> <p>This form will state the work to be carried out, as well as the date for submitting and opening tenders and the time allowed for carrying out the work, also the amount of earnest money to be deposited with the tender, and the amount of the security deposit and Performance Security to be deposited by the successful tenderer and the percentage, if any, to be deducted from bills.</p> |
| | 2. | <p>In the event of the tender being submitted by a Partnership firm, it must be signed separately by each partner thereof or in the event of the absence of any partner, it must be signed on his behalf by a person holding a Power of Attorney authorizing him to do so, such power of attorney to be produced with the tender, and it must disclose that the firm is duly registered under the Indian Partnership Act, 1952.</p> |
| | 3. | <p>Receipts for payment made on account of work, when executed by a firm, must also be signed by all the partners, except where contractors are described in their tender as a firm, in which case the receipts must be signed in the name of the firm by one of the partners, or by some other person having due authority to give effectual receipts for the firm</p> |
| Applicable for Items Rate tender only | 4. | <p>The rate(s) must be quoted in decimal coinage. Total Amount must be quoted in full rupees by ignoring fifty paisa and considering more than fifty paisa as rupee one.</p> <p>In case the lowest tendered amount (worked out on the basis of quoted rate of Individual items) of two or more contractors is same, then such lowest contractors may be asked to submit sealed revised online offer (through limited tender process) quoting rate/ cost of work of each item of the schedule of quantity for all sub sections/sub heads as the case may be, but the revised quoted rate of each item of schedule of quantity for all sub sections/sub heads should not be higher than their respective original rate quoted already at the time of submission of tender. The lowest tender shall be decided on the basis of revised offer.</p> <p>If the revised tendered amount (worked out on the basis of quoted rate of individual items) of two or more contractors received in revised offer is again found to be equal, then the lowest tender, among such contractors, shall be decided by draw of lots in presence of WAPCOS and the lowest contractors those have quoted equal amount of their tenders.</p> <p>In case of any such lowest contractor in his revised offer quotes rate of any item more than their respective original rate quoted already at the time of submission of tender, then such revised offer shall be treated invalid. Such case of revised offer of the lowest contractor or case of refusal to submit revised offer by the lowest contractor shall be treated as withdrawal of his tender before acceptance and 50% of his earnest money shall be forfeited.</p> <p>In case all the lowest contractors those have same tendered amount (as a result of their quoted rate of individual items), refuse to submit revised</p> |

| | | |
|---|----|--|
| | | <p>offers, then tenders are to be recalled after forfeiting 50% of EMD of each lowest contractors.</p> <p>Contractor, whose earnest money is forfeited because of non-submission of revised offer, or quoting higher revised rate(s) of any item(s) than their respective original rate quoted already at the time of submission of his bid shall not be allowed to participate in the retendering process of the work</p> |
| Applicable for Percentage Rate/ EPC tender only | 4A | <p>In case of Percentage Rate /EPC Tenders, contractor shall fill up the usual printed form, stating at what percentage below/above (in figures as well as in words) the total estimated cost given in Schedule of Quantities , he will be willing to execute the work. The tender submitted shall be treated as invalid if :-</p> <ol style="list-style-type: none"> 1. The contractor does not quote percentage above/below on the total amount of tender or any section/sub head of the tender. 2. The percentage above/below is not quoted in figures & words both on the total amount of tender or any section/sub head of the tender. 3. The percentage quoted above/below is different in figures & words on the total amount of tender or any section/sub head of the tender. <p>Tenders, which propose any alteration in the work specified in the said form of invitation to tender, or in the time allowed for carrying out the work, or which contain any other conditions of any sort including conditional rebates, will be summarily rejected.</p> |
| | 4B | <p>In case the lowest tendered amount (estimated cost + amount worked on the basis of percentage above/below) of two or more contractors is same, such lowest contractors will be asked to submit sealed revised offer in the form of letter mentioning percentage above/ below on estimated cost of tender including all sub sections/sub heads as the case may be, but the revised percentage quoted above/below on tendered amount or on each sub section/ sub head should not be higher than the percentage quoted at the time of submission of tender. The lowest tender shall be decided on the basis of revised offers.</p> <p>In case any of such contractor refuses to submit revised offer, then it shall be treated as withdrawal of his tender before acceptance and 50% of earnest money shall be forfeited.</p> <p>If the revised tendered amount of two more contractors received in revised offer is again found to be equal , the lowest tender, among such contractors, shall be decided by draw of lots in the presence WAPCOS & the lowest contractors those have quoted equal amount of their tenders.</p> <p>In case all the lowest contractors those have quoted same tendered amount, refuse to submit revised offers, then tenders are to be recalled after forfeiting 50% of EMD of each contractor, whose earnest money is forfeited because of non-submission of revised offer, shall not be allowed to participate in the re-tendering process of the work.</p> |
| | 5. | <p>The designated committee will open tenders in the presence of any intending contractors who may be present at the time, and will enter the amounts of the several tenders in a comparative statement in a suitable form. In the event of a tender being accepted, a receipt for the earnest money shall thereupon be given to the contractor who shall thereupon for the purpose</p> |

| | | |
|--|-----|---|
| | | of identification sign copies of the specifications and other documents. In the event of a tender being rejected, the earnest money shall thereupon be returned to the contractor remitting the same, without any interest. |
| | 6. | The officer Inviting Tenders shall have the right of rejecting all or any of the tenders and will not be bound to accept the lowest or any other tender |
| | 7. | The receipt of an accountant or clerk for any money paid by the contractor will not be considered as any acknowledgment or payment to the officer inviting tender and the contractor shall be responsible for seeing that he procures a receipt signed by the officer inviting tender or a duly authorized Cashier. |
| Applicable for Items Rate tender only | 8. | <p>In the case of Item Rate Tenders, only rates quoted shall be considered. Any tender containing percentage below/above the rates quoted is liable to be rejected. Rates quoted by the contractor in item rate tender in figures and words shall be accurately filled in so that there is no discrepancy in the rates written in figures and words. However, if a discrepancy is found, the rates which correspond with the amount worked out by the contractor shall unless otherwise proved be taken as correct. If the amount of an item is not worked out by the contractor or it does not correspond with the rates written either in figures or in words, then the rates quoted by the contractor in words shall be taken as correct. Where the rates quoted by the contractor in figures and in words tally, but the amount is not worked out correctly, the rates quoted by the contractor will unless otherwise proved be taken as correct and not the amount. In event no rate has been quoted for any item(s), leaving space both in figure(s), word(s), and amount blank, it will be presumed that the contractor has included the cost of this/these item(s) in other items and rate for such item(s) will be considered as zero and work will be required to be executed accordingly.</p> <p>However, if a tenderer quotes nil rates against each item in item rate tender, the tender shall be treated as invalid and will not be considered as lowest tenderer and earnest money deposited shall be forfeited.</p> |
| Applicable for Percentage Rate /EPC tender only | 9. | In case of Percentage Rate / EPC Tenders only percentage quoted shall be considered. Any tender containing item rates is liable to be rejected. Percentage quoted by the contractor in percentage rate tender shall be accurately filled in figures and words, so that there is no discrepancy |
| Applicable for Percentage Rate EPC tender only | 10. | In Percentage Rate /EPC Tender, the tenderer shall quote percentage below/above (in figures as well as in words) at which he will be willing to execute the work. He shall also work out the total amount of his offer and the same should be written in figures as well as in words in such a way that no interpolation is possible. In case of figures, the word 'Rs.' should be written before the figure of rupees and word 'P' after the decimal figures, e.g. 'Rs. 2.15P' and in case of words, the word 'Rupees' should precede and the word 'Paisa' should be written at the end. |
| | 11. | <p>i. The Contractor, whose tender is accepted, will be required to furnish Performance Security of 5% of the Tendered Value. This Security shall be in the form of cash (in case Security amount is less than Rs. 10,000/-) or Deposit at call receipt of any scheduled bank/Banker's cheque of any scheduled bank/Demand Draft of any scheduled bank/Pay order of any scheduled bank (in case Security amount is less than Rs. 1,00,000/-) or Government Securities or Fixed Deposit Receipts or Guarantee Bonds of any Scheduled Bank or the State Bank of India in the with the prescribed form.</p> |

| | | |
|--|-----|--|
| | | <p>ii. The contractor whose tender is accepted will also be required to furnish by way of Security Deposit for the fulfillment of his contract, an amount equal to 2.5% of the value of each Running & Final bill. The Security deposit will be collected by deductions from the running bills as well as final bill of the contractor at the rates mentioned above. The Security amount will also be accepted in cash or in the shape of Government Securities. Fixed Deposit Receipt of a Scheduled Bank or State Bank of India will also be accepted for this purpose provided confirmatory advice is enclosed</p> |
| | 12. | On acceptance of the tender, the name of the accredited representative(s) of the contractor who would be responsible for taking instructions from the Engineer-in-Charge shall be communicated in writing to the Engineer-in-Charge. |
| | 13. | GST or any other tax applicable in respect of inputs procured by the contractor for this contract shall be payable by the Contractor and Government will not entertain any claim whatsoever in respect of the same. |
| | 14. | The contractor shall give a list of WAPCOS employees related to him. |
| | 15. | The tender for composite work includes, in addition to building work, all other works such as sanitary and water supply installations drainage installation, electrical work, horticulture work, roads and paths etc. |

2.0 CONDITIONS OF CONTRACT

| | | |
|---------------------------|-----------|--|
| <p>Definitions</p> | <p>1.</p> | <p>The “Contract” means the documents forming the tender and acceptance thereof and the formal Agreement executed between the WAPCOS and the Contractor, together with the documents referred to therein including these conditions, the specifications, designs, drawings and instructions issued from time to time by the Engineer-In-Charge and all these documents taken together, shall be deemed to form one contract and shall be complementary to one another.</p> |
| | <p>2.</p> | <p>In the contract, the following expressions shall, unless the context otherwise requires, have the meanings, hereby respectively assigned to them:-</p> <ul style="list-style-type: none"> i. “Employer” shall mean WAPCOS Limited/ WAPCOS, A Government of India undertaking- Ministry of Jal Shakti, for execution of the Work / Project as mentioned in NIT, having their Registered office at 5th floor, Kailash building, 26-Kasturba Gandhi Marg, New Delhi-110001, India & include Engineer-in-charge, Project Manager, their successors & permitted assigns as well as their authorized officer / representatives. WAPCOS Limited is a company registered under the Indian Company Act 1956, with its registered office at New Delhi or its Administrative officers or its Engineer or other employees authorized to deal with any matter with which these persons are concerned and authorized on its behalf. ii. “Principal Employer/Owner” National Education Society for Tribal Students (NESTS), Ministry of Tribal Affairs, Govt. of India, who has appointed WAPCOS Ltd. as Project Management Consultant for the work mentioned in NIT. iii. “Bidder/Tenderer/Contractor/Supplier” shall mean the individual, firm or company, whether incorporated or not, undertaking the works and shall include the legal personal representative of such individual or the persons composing such firm or company, or the successors of such firm or company and the permitted assignees of such individual, firm or company who are participating in Bidding process and will Execute the project after award of the Works as Contractor/Supplier. They should be an Indian Registered Company under Companies Act 1956/ 2013, Proprietorship Firm/ Partnership Firm iv. “Work or Project” means as mentioned in NIT. v. “Site and location” means the land/or other places on, into or through which work is to be executed under the contract or any adjacent land, path or street through which work is to be executed under the contract or any adjacent land, path or street which may be allotted or used for the purpose of carrying out the contract as mentioned in NIT. vi. “Engineer-in-Charge” means the Officer appointed by WAPCOS who shall direct, supervise and sign the Contract Agreement on behalf of WAPCOS, for the purpose of Contract or his duly authorized representative. vii. “Project Manager, WAPCOS” shall mean the officer appointed by WAPCOS to supervise the works at site on behalf of WAPCOS and Authorized by the Engineer-in charge. |

| | | |
|--------------------------------|----|--|
| | | <p>viii. Excepted Risk are risks due to riots (other than those on account of contractor's employees), war (whether declared or not) invasion, act of foreign enemies, hostilities, civil war, rebellion revolution, insurrection, military or usurped power, any acts of Government, damages from aircraft, acts of God, such as earthquake, lightening and unprecedented floods, and other causes over which the contractor has no control and accepted as such by the Engineer-in-charge or causes solely due to use or occupation by Government of the part of the works in respect of which a certificate of completion has been issued or a cause solely due to Government's faulty design of works.</p> <p>ix. "Market Rate" shall be the rate as checked & verified by the Project Manager, WAPCOS and agreed by the Engineer-in-Charge on the basis of the cost of materials and labour at the site where the work is to be executed plus the percentage mentioned in Special Conditions of Contract to cover, all overheads and profits.</p> <p>x. "Schedule(s)" referred to in these conditions shall mean the relevant schedule(s), standard Schedule of Rates of the government mentioned in Special Conditions of Contract.</p> <p>xi. "Consultant" means any consultant nominated by the WAPCOS</p> <p>xii. "Tendered Amount" means the value as quoted by the Bidder during bidding process excluding GST.</p> <p>xiii. "Tendered Value" means the value of work as stipulated in the letter of award excluding GST.</p> <p>xiv. "Contract Price" means the value of work executed under the Contract including tendered value, cost of extra items, cost of substituted items, cost of deviated items, works executed under the Contract including GST.</p> <p>xv. "Date of Commencement of Work" The date of commencement of work shall be the date of start as specified in Letter of Award or the first date of handing over of the site, whichever is later, in accordance with the phasing if any, as indicated in the tender document.</p> <p>xvi. GST means Goods & Service tax- Central, State and Inter State</p> |
| Scope and Performance | 3. | Where the context so requires, words imparting the singular only also include the plural and vice versa. Any reference to masculine gender shall whenever required include feminine gender and vice versa. |
| | 4. | Headings and Marginal notes to these General Conditions of Contract shall not be deemed to form part thereof or be taken into consideration in the interpretation or construction thereof or of the contract. |
| | 5. | The contractor shall be furnished, free of cost one certified copy of the contract documents except standard specifications, and such other printed and published documents, together with all drawings as may be forming part of the tender papers. None of these documents shall be used for any purpose other than that of this contract. |
| Works to be carried out | 6. | The work to be carried out under the Contract shall, except as otherwise provided in these conditions, include all labour, materials, tools, plants, equipment and transport which may be required in preparation of and for and in the full and entire execution and completion of the works. The descriptions given in the Schedule of Quantities/ Building Components shall, unless otherwise stated, be held to include wastage on materials, carriage and cartage, carrying and return of empties, hoisting, setting, fitting and fixing in position and all other labours necessary in and for the full and |

| | | |
|---|-----|--|
| | | entire execution and completion of the work as aforesaid in accordance with good practice and recognized principles. |
| Sufficiency of Tender | 7. | The Contractor shall be deemed to have satisfied himself before tendering as to the correctness and sufficiency of his tender for the works and of the cost quoted in the Schedule of Quantities/ Building Components, which rates and prices shall, except as otherwise provided, cover all his obligations under the Contract and all matters and things necessary for the proper completion and maintenance of the works. |
| Discrepancies and Adjustment of Errors | 8. | The several documents forming the Contract are to be taken as mutually explanatory of one another, detailed drawings being followed in preference to small scale drawing and figured dimensions in preference to scale and special conditions in preference to General Conditions. |
| | 8.1 | In the case of discrepancy between the schedule of Quantities/Building Components, the Specifications and/ or the Drawings, the following order of preference shall be observed:- i. Description of Schedule of Quantities/ Building Components. ii. Particular Specification and Special Condition, if any. iii. Drawings. iv. Standard Specifications. v. Indian Standard Specifications of B.I.S. |
| | 8.2 | If there are varying or conflicting provisions made in any one document forming part of the contract, the Engineer-in-charge shall be the deciding authority with regard to the intention of the document and his decision shall be final and binding on the contractor. |
| | 8.3 | Any error in description, quantity or rate in Schedule of Quantities or any omission therefrom shall not vitiate the Contract or release the Contractor from the execution of the whole or any part of the works comprised therein according to drawings and specifications or from any of his obligations under the contract. |
| Signing of Contract | 9. | <p>The letter of Award will be issued to the successful bidder by WAPCOS which will be duly signed & stamped by the successful bidder as token of unequivocal acceptance and confirmation. Subsequently, successful bidder will submit the Performance Security of required value within time specified in Tender document. Thereafter, on a date and time mutually agreed upon, the successful Bidder or his authorized representative shall attend the office for signing of the Contract Agreement.</p> <p>The contract Agreement consisting of complete Tender Document along with all the documents Corrigendum/Amendments if any, Clarifications / Correspondences and any other documents as forming part of the contract. No payment for the work done will be made unless contract is signed by the contractor.</p> <p>Failure on the part of the successful Bidder to comply with the above requirements will constitute sufficient grounds for the annulment of the Award and forfeiture of the Bid Security.</p> |

2.0 CLAUSES OF CONTRACT

CLAUSE 1: PERFORMANCE SECURITY (OR PERFORMANCE BANK GUARANTEE)

- i. The contractor shall submit an irrevocable **Performance Security of 5% (Five percent) of the “Tendered Value”** in addition to other deposits mentioned elsewhere in the contract for his proper performance of the contract agreement, (not withstanding and/or without prejudice to any other provisions in the contract) within period specified in Special Conditions of Contract from the date of issue of letter of acceptance. This period can be further extended by the Engineer-in-Charge up to a maximum period as specified in Special Conditions of Contract on written request of the contractor stating the reason for delays in procuring the Performance Security, to the satisfaction of the Engineer-in-Charge. This Security shall be in the form of Cash (in case Security amount is less than Rs. 10,000/-) or Banker’s Cheque of any scheduled bank/Demand Draft of any scheduled bank/Pay Order of any scheduled bank (in case Security amount is less than Rs. 1,00,000/-) or Fixed Deposit Receipts or Guarantee Bonds of any Scheduled Bank or the State Bank of India in accordance with the form annexed hereto. In case a fixed deposit receipt of any Bank is furnished by the contractor to the WAPCOS as part of the performance Security and the Bank is unable to make payment against the said fixed deposit receipt, the loss caused thereby shall fall on the contractor and the contractor shall forthwith on demand furnish additional security to the WAPCOS to make good the deficit.
- ii. **The Performance Security shall be initially valid up to period of 60 (sixty) days beyond the date of completion of all contractual obligations of the contractor, including Defect Liability Period (DLP) plus 1 year claim period beyond that.** In case the time for completion of work gets enlarged, the contractor shall get the validity of Performance Security extended to cover such enlarged time. The performance Security shall be refunded to the contractor without interest, after he duly performs and completes all obligations under the contract including completion of the Defect Liability Period.
- iii. The Engineer-in-Charge shall make a claim under the performance Security except for amounts to which the WAPCOS is entitled under the contract (not withstanding and/or without prejudice to any other provisions in the contract agreement) in the event of:
- iv. Failure by the contractor to extend the validity of the Performance Security as described herein above, in which event the Engineer-in-Charge may claim the full amount of the Performance Security.
 - a) Failure by the contractor to pay WAPCOS any amount due, either as agreed by the contractor or determined under any of the Clauses/Conditions of the agreement, within 30 days of the service of notice to this effect by Engineer-in-Charge.
- v. In the event of the contract being determined or rescinded under provision of any of the Clause/Condition of the agreement, the performance Security shall stand forfeited in full and shall be absolutely at the disposal of the WAPCOS.

CLAUSE 1A: SECURITY DEPOSIT / RETENTION MONEY

The Bidder whose tender(s) may be accepted shall permit WAPCOS at the time of making any payment to Contractor for work done under the contract to deduct a sum at the rate of 2.5% from each running and final bill excluding GST.

The Security Deposit as deducted above shall be released within 60 days of successful completion of Warranty/Defect Liability as Certified by the Engineer-in-Charge or till the final bill has been prepared and passed whichever is later.

CLAUSE 2: COMPENSATION FOR DELAY i.e. LIQUIDITY DAMAGE

If the contractor fails to maintain the required progress or to complete the work and clear the site on or before the contract or extended date of completion, he shall, without prejudice to any other right or remedy available under purview of the Contract on account of such breach, pay compensation for delay

i.e. Liquidity Damage, a sum not less than 1.0% (One percent) of the Tendered Value as aforesaid for each week and limited to 10% of the Contract Price.

In case Liquidity Damage imposed by Principal Employer to the project at any point of time, then full amount of Liquidity Damage (10% of the Contract Price) will be recovered from the up-coming interim bills/ final bill. If the amount of up-coming interim bills/ final bill is less than the amount of Liquidity Damage, then balance amount of Liquidity Damage will be recovered from the Performance Security, Security Deposit and any other financial deposit of Contractor with Employer.

CLAUSE 3: WHEN CONTRACT CAN BE DETERMINED

Subject to other provisions contained in this clause, the Engineer-in-Charge may, without prejudice to his any other rights or remedy against the contractor in respect of any delay, inferior workmanship, any claims for damages and/or any other provisions of this contract or otherwise, and whether the date of completion has or has not elapsed, by notice in writing absolutely determine the contract in any of the following cases:

- i. If the contractor having been given by the Engineer-in-Charge a notice in writing to rectify, reconstruct or replace any defective work or that the work is being performed in an inefficient or otherwise improper or unworkman like manner shall omit to comply with the requirement of such notice for a period of seven days thereafter.
- ii. If the contractor has, without reasonable cause, suspended the progress of the work or has failed to proceed with the work with due diligence so that in the opinion of the Engineer-in-Charge (which shall be final and binding) he will be unable to secure completion of the work by the date for completion and continues to do so after a notice in writing of seven days from the Engineer-in-Charge.
- iii. If the contractor fails to complete the work or section of work with individual date of completion on or before the stipulated or justified extended date, on or before such date of completion; and the Engineer-in-charge without any prejudice to any other right or remedy under any other provision in the contract has given further reasonable time in a notice given in writing in that behalf as either mutually agreed or in absence of such mutual agreement by his own assessment making such time essence of contract and in the opinion of Engineer-in-Charge the contractor will be unable to complete the same or does not complete the same within the period specified.
- iv. If the contractor persistently neglects to carry out his obligations under the contract and/ or commits default in complying with any of the terms and conditions of the contract and does not remedy it or take effective steps to remedy it within 7 days after a notice in writing is given to him in that behalf by the Engineer-in-Charge.
- v. If the contractor shall offer or give or agree to give to any person in WAPCOS service or to any other person on his behalf any gift or consideration of any kind as an inducement or reward for doing or forbearing to do or for having done or forborne to do any act in relation to the obtaining or execution of this or any other contract for WAPCOS.
- vi. If the contractor shall enter into a contract with WAPCOS in connection with which commission has been paid or agreed to be paid by him or to his knowledge, unless the particulars of any such commission and the terms of payment thereof have been previously disclosed in writing to the Engineer-in-Charge.
- vii. If the contractor had secured the contract with WAPCOS as a result of wrong tendering or other non-bonafide methods of competitive tendering or commits breach of Integrity Agreement.
- viii. If the contractor being an individual, or if a firm, any partner thereof shall at any time be adjudged insolvent or have a receiving order or order for administration of his estate made against him or shall take any proceedings for liquidation or composition (other than a voluntary liquidation for the purpose of amalgamation or reconstruction) under any Insolvency Act for the time being in force or make any conveyance or assignment of his effects or composition or arrangement for the benefit of his creditors or purport so to do, or if any application be made under any Insolvency Act for the time being in force for the sequestration of his estate or if a trust deed be executed by him for benefit of his creditors.

- ix. If the contractor being a company shall pass a resolution or the court shall make an order that the company shall be wound up or if a receiver or a manager on behalf of a creditor shall be appointed or if circumstances shall arise which entitle the court or the creditor to appoint a receiver or a manager or which entitle the court to make a winding up order.
- x. If the contractor shall suffer an execution being levied on his goods and allow it to be continued for a period of 21 days.
- xi. If the contractor assigns (excluding part(s) of work assigned to other agency(s) by the contractor as per terms of contract), transfers, sublets (engagement of labour on a piece-work basis or of labour with materials not to be incorporated in the work, shall not be deemed to be subletting) or otherwise parts with or attempts to assign, transfer, sublet or otherwise parts with the entire works or any portion thereof without the prior written approval of the Engineer -in-Charge. When the contractor has made himself liable for action under any of the cases aforesaid, the Engineer-in-Charge on behalf of the WAPCOS shall have powers:
 - (a) To determine the contract as aforesaid so far as performance of work by the Contractor is concerned (of which determination notice in writing to the contractor under the hand of the Engineer-in-Charge shall be conclusive evidence). Upon such determination, Security Deposit already recovered, Security deposit payable and Performance Security under the contract shall be liable to be forfeited and shall be absolutely at the disposal of the Government.
 - (b) After giving notice to the contractor to measure up the work of the contractor and to take such whole, or the balance or part thereof, as shall be un-executed out of his hands and to give it to another contractor to complete the work. The contractor, whose contract is determined as above, shall not be allowed to participate in the tendering process for the balance work including any new items needed to complete the work. In the event of above courses being adopted by the Engineer-in-Charge, the contractor shall have no claim to compensation for any loss sustained by him by reasons of his having purchased or procured any materials or entered into any engagements or made any advances on account or with a view to the execution of the work or the performance of the contract. And in case action is taken under any of the provision aforesaid, the contractor shall not be entitled to recover or be paid any sum for any work thereof or actually performed under this contract unless and until the Engineer-in-Charge has certified in writing the performance of such work and the value payable in respect thereof and he shall only be entitled to be paid the value so certified.

Note:

Actions under Clause 2 and 3 are independent.

The compensation under Clause 2 is for loss caused due to delay in performance, whereas, the compensation under Clause 3 is for consequential losses due to non-performance of the Contract. Hence, the Employer is entitled to compensation under Clause 3 and Clause 2 independently. Hence, the Employer is empowered to take action under Clause 2 for levy of compensation depending on liability of Contractor under Clause 2 based on the delay at the stage of Clause 3 action, before determination.

CLAUSE 3A

In case, the work cannot be started due to reasons not within the control of the contractor within 1/6th of the stipulated time for completion of work or one month whichever is higher, either party may close the contract. In case contractor wants to close the contract, he shall give notice to the WAPCOS stating the failure on the part of WAPCOS. In such eventuality, the Performance Security of the contractor shall be refunded within following time limits :

- | | | |
|----|--|---------|
| a) | Tendered value of work is up to Rs. 1.0 Crore | 15 days |
| b) | If the Tendered value of work is more than Rs.1.0 crore and up to Rs. 10 Crore | 21 days |
| c) | If the Tendered value of work exceeds Rs. 10 Crore : | 30 days |

Neither party shall claim any compensation for such eventuality. This clause is not applicable for any breach of the contract by either party

CLAUSE 4: CONTRACTOR LIABLE TO PAY COMPENSATION EVEN IF ACTION NOT TAKEN UNDER CLAUSE 3

In any case in which any of the powers conferred upon the Engineer-in-Charge by Clause-3 thereof, shall have become exercisable and the same are not exercised, the non-exercise thereof shall not constitute a waiver of any of the conditions hereof and such powers shall notwithstanding be exercisable in the event of any future case of default by the contractor and the liability of the contractor for compensation shall remain unaffected. In the event of the Engineer-in-Charge putting in force all or any of the powers vested in him under the preceding clause he may, if he so desires after giving a notice in writing to the contractor, take possession of (or at the sole discretion of the Engineer-in-Charge which shall be final and binding on the contractor) use as on hire (the amount of the hire money being also in the final determination of the Engineer-in-Charge) all or any tools, plant, materials and stores, in or upon the works, or the site thereof belonging to the contractor, or procured by the contractor and intended to be used for the execution of the work/or any part thereof, paying or allowing for the same in account at the contract rates, or, in the case of these not being applicable, at current market rates to be certified by the Engineer-in-Charge, whose certificate thereof shall be final, and binding on the contractor, clerk of the works, foreman or other authorized agent to remove such tools, plant, materials, or stores from the premises (within a time to be specified in such notice) in the event of the contractor failing to comply with any such requisition, the Engineer-in-Charge may remove them at the contractor's expense or sell them by auction or private sale on account of the contractor and his risk in all respects and the certificate of the Engineer-in-Charge as to the expenses of any such removal and the amount of the proceeds and expenses of any such sale shall be final and conclusive against the contractor.

CLAUSE 5: TIME AND EXTENSION FOR DELAY

The time allowed for execution of the Works as specified in Contract or the extended time in accordance with these conditions shall be the essence of the Contract. The execution of the works shall commence from such time period as mentioned in Contract or from the date of handing over of the site whichever is later. If the Contractor commits default in commencing the execution of the work as aforesaid, WAPCOS shall without prejudice to any other right or remedy available in law, be at liberty to forfeit the performance Security absolutely.

- 5.1** As soon as possible but within 7 (seven) days from the date of commencement of work, the Contractor shall submit a Time and Progress Chart for each milestone and get it approved by the Engineer-in-Charge. The Chart shall be prepared in direct relation to the time stated in the Contract documents for completion of items of the works. It shall indicate the forecast of the dates of commencement and completion of various trades of sections of the work and may be amended as necessary by agreement between the Employer and the Contractor within the limitations of time imposed in the Contract documents, and further to ensure good progress during the execution of the work, the Contractor shall in all cases in which the time allowed for any work, exceeds 15 days (save for special jobs for which a separate programme has been agreed upon) complete the work as per scheduled date of completion.

In case of non submission of construction programme by the contractor, the program approved by the Engineer-in-Charge shall be deemed to be final.

The approval by the Engineer-in-Charge of such programme shall not relieve the contractor of any of the obligations under the contract.

The contractor shall submit the Time and Progress Chart and Progress Report using the mutually agreed software or in other format decided by Engineer-in-Charge for the work done during previous month to the Engineer-in-charge on or before 5th day of each month failing which a

recovery of Rs. 2500/- per day basis in case of delay in submission of Time and Progress Chart and Rs. 1000/- per day in case of delay in submission of the monthly progress report.

5.2 If the work(s) be delayed by :-

- (i) force majeure, or
- (ii) abnormally bad weather, or
- (iii) serious loss or damage by fire, or
- (iv) civil commotion, local commotion of workmen, strike or lockout, affecting any of the trades employed on the work, or
- (v) delay on the part of other contractors or tradesmen engaged by Engineer-in-Charge in executing work not forming part of the Contract, or
- (vi) any other cause which, in the absolute discretion of the Engineer-in-Charge is beyond the Contractor's control.

then upon the happening of any such event causing delay, the Contractor shall immediately give notice thereof in writing to the authority, but shall nevertheless use constantly his best endeavours to prevent or make good the delay and shall do all that may be reasonably required to the satisfaction of the Engineer-in-Charge to proceed with the works.

The contractor shall have no claim of damages for extension of time granted or rescheduling of milestone/s for above events listed.

5.3 In case the work is hindered by the Employer/ Principal Employer for any reason / event, the Engineer-in-Charge, if justified, give a fair and reasonable extension of time and reschedule the mile stones for completion of work. Such extension of time or rescheduling of milestone/s shall be without prejudice to any other right or remedy of the parties in contract or in law; provided further that for concurrent delays under this sub-clause and sub-clause 5.2 to the extent the delay is covered under sub-clause 5.2 the Contractor shall be entitled to only extension of time and no compensation/damages.

5.4 Request for rescheduling of Milestones and extension of time, to be eligible for consideration, shall be made by the Contractor in writing within fourteen days of the happening of the event causing delay on the prescribed form to the Engineer-in-Charge. The Contractor may also, if practicable, indicate in such a request the period for which extension is desired. The Contractor shall indicate in such a request the period by which rescheduling of milestone/s or extension of time is desired. With every request for rescheduling of milestones, or if at any time the actual progress of work falls behind the approved programme by more than 10% of the stipulated period of completion of contract, the Contractor shall produce a revised programme which shall include all details of pending drawings and decisions required to complete the contract and also the target dates by which these details should be available without causing any delay in execution of the work. An amount as deemed appropriate by the Engineer-in-Charge shall be deducted on per day basis in case of delay in submission of the revised programme.

5.4.1 In any such case the Engineer-in-Charge may give a fair and reasonable extension of time for completion of work or reschedule the mile stones. Engineer-in-Charge shall finalize/ reschedule a particular mile stone before taking an action against subsequent mile stone. Such extension or rescheduling of the milestones shall be communicated to the Contractor by the Engineer-in-Charge in writing, within 21 days of the date of receipt of such request from the Contractor in prescribed form. In event of non-application by the Contractor for extension of time Engineer-in-Charge after affording opportunity to the Contractor, may give, supported with a programme, a fair and reasonable extension within a reasonable period of occurrence of the event.

- 5.5 In case the work is delayed by any reasons, in the opinion of the Engineer-in-Charge, by the Contractor for reasons beyond the events mentioned in sub clause 5.2 and beyond the justified extended date; without prejudice to right to take action under Clause 3, the Engineer-in-Charge may grant extension of time required for completion of work without rescheduling of milestones. The Contractor shall be liable for levy of compensation for delay for such extension of time.

CLAUSE 6 : COMPUTERIZED MEASUREMENT BOOK

Project Manager, WAPCOS shall, except as otherwise provided, ascertain and determine by measurement the value of work done in accordance with the contract.

All measurements of all items having financial value shall be entered by the contractor and compiled in the shape of the Computerized Measurement Book having pages of A-4 size as per the format of the WAPCOS so that a complete record is obtained of all the items of works performed under the contract. All such measurements and levels recorded by the contractor or his authorized representative from time to time, during the progress of the work, shall be got checked by the contractor from the Project Manager, WAPCOS as per interval or program fixed in consultation with Engineer-in-Charge or his authorized representative. After the necessary corrections made by the Project Manager, WAPCOS, the measurement sheets shall be returned to the contractor for incorporating the corrections and for resubmission to the Project Manager, WAPCOS, for the dated signatures by the Project Manager, WAPCOS, and the contractor or their representatives in token of their acceptance.

Whenever bill is due for payment, the contractor would initially submit draft computerized measurement sheets and these measurements would be got checked/test checked from the Project Manager, WAPCOS. The contractor will, thereafter, incorporate such changes as may be done during these checks/test checks in his draft computerized measurements, and submit to the WAPCOS a computerized measurement book, duly bound, and with its pages machine numbered. The Project Manager, WAPCOS, would thereafter check this MB, and record the necessary certificates for their checks/test checks.

The final, fair, computerized measurement book given by the contractor, duly bound, with its pages machine numbered, should be 100% correct, and no cutting or over-writing in the measurements would thereafter be allowed. If at all any error is noticed, the contractor shall have to submit a fresh computerized MB with its pages duly machine numbered and bound.

The contractor shall also submit to the WAPCOS separately his computerized Abstract of Cost and the bill based on these measurements, duly bound, and its pages machine numbered. Thereafter, this bill will be processed by the Project Manager, WAPCOS.

The contractor shall, without extra charge, provide all assistance with every appliance, labour and other things necessary for checking of measurements/levels by the Project Manager, WAPCOS.

Except where any general or detailed description of the work expressly shows to the contrary, measurements shall be taken in accordance with the procedure set forth in the specifications notwithstanding any provision in the relevant Standard Method of measurement or any general or local custom. In the case of items which are not covered by specifications, measurements shall be taken in accordance with the relevant standard method of measurement issued by the Bureau of Indian Standards and if for any item no such standard is available then a mutually agreed method shall be followed.

The contractor shall give not less than seven days' notice to the Project Manager, WAPCOS in charge of the work before covering up or otherwise placing beyond the reach of checking and/or test checking the measurement of any work in order that the same may be checked and/or test checked and correct dimensions thereof be taken before the same is covered up or placed beyond the reach of checking

and/or test checking measurement and shall not cover up and place beyond reach of measurement any work without consent in writing of the Project Manager, WAPCOS in charge of the work who shall within the aforesaid period of seven days inspect the work, and if any work shall be covered up or placed beyond the reach of checking and/or test checking measurements without such notice having been given or Project Manager, WAPCOS consent being obtained in writing the same shall be uncovered at the Contractor's expense, or in default thereof no payment or allowance shall be made for such work or the materials with which the same was executed.

Engineer-in-Charge may cause either themselves or through another officer of the WAPCOS to check the measurements recorded by contractor and all provisions stipulated herein above shall be applicable to such checking of measurements or levels.

It is also a term of this contract that checking and/or test checking the measurements of any item of work in the measurement book and/or its payment in the interim, on account of final bill shall not be considered as conclusive evidence as to the sufficiency of any work or material to which it relates nor shall it relieve the contractor from liabilities from any over measurement or defects noticed till completion of the defects liability period.

CLAUSE 7: PAYMENT ON INTERMEDIATE CERTIFICATE TO BE REGARD AS ADVANCE

The interim or running account bill shall be submitted by the Contractor for work executed on the basis of recorded measurements on the format of the Employer on or before the date of every month fixed by Project Manager of WAPCOS. Contractor shall submit the bill with all requisite certificates/documents. Project Manager of WAPCOS shall arrange to have the bill verified by taking or causing to be taken where necessary, the requisite measurement of the work within 15 working days. Observations if any shall be conveyed by the Project Manager, WAPCOS to the Contractor within 25 working days. Contractor shall resubmit the bill to Project Manager, WAPCOS after compliance of observations and duly signed by the Project Manager of WAPCOS for further processing.

Payment on account of amount admissible shall be made by the Engineer-in-Charge certifying the sum to which the Contractor is considered entitled by way of interim payment at such rates as decided by Engineer-in-Charge. The amount shall be paid by 45 working days after the day of presentation of the corrected bill by the Contractor to the Engineer-in-Charge or his representative, or 45 days after receive of the payments from Principal Employer whichever is later. As Bidder/Contractor acknowledges that under the present Contract agreement, the Employer is only working as intermediary between Principal Employer and Contractor. Thus, the Contractor unconditionally acknowledge that the payments under the present Contract shall be made proportionately by the Employer only on back-to-back basis i.e., after 45 days subject to receipt of payment from Principal Employer. The Contractor also unconditionally agree that in the event the payment or part thereof, under the present Contract is not received from Principal Employer, then WAPCOS and/or any of its Employee/Officer shall not be responsible to pay any amount to Contractor. The said condition shall supersede any and all other conditions of Contract/Agreement/Work Order/Arrangement between the parties.

All such interim payments shall be regarded as payment by way of advances against final payment only and shall not preclude the requiring of bad, unsound and imperfect or unskilled work to be rejected, removed, taken away and reconstructed or re-erected. Any certificate given by the Engineer-in-Charge relating to the work done or materials delivered forming part of such payment, may be modified or corrected by any subsequent such certificate(s) or by the final certificate and shall not by itself be conclusive evidence that any work or materials to which it relates is/are in accordance with the contract and specifications. Any such interim payment, or any part thereof shall not in any respect conclude, determine or affect in any way powers of the Engineer-in-Charge under the contract or any of such

payments be treated as final settlement and adjustment of accounts or in any way vary or affect the contract.

Pending consideration of extension of date of completion, interim payments shall continue to be made as herein provided without prejudice to the right of the WAPCOS to take action under the terms of this contract for delay in the completion of work, if the extension of date of completion is not granted by the competent authority.

It is clearly agreed and understood by the Contractor that notwithstanding anything to the contrary that may be stated in the agreement between Employer and the Contractor; the Contractor shall become entitled to payment only after Employer has received the corresponding payment(s) from the Principal Employer for the work done by the Contractor. Any delay in the release of payment by the Principal Employer to Employer leading to a delay in the release the corresponding payment by Employer to the Contractor shall not entitle the Contractor to any compensation/interest from Employer.

All payments shall be released by way of e-transfer through RTGS in India directly at their Bank account by Employer.

Clause 7A

No Running Account Bill shall be paid for the work till the applicable labour licenses, registration with EPFO, ESIC / BOCW Welfare Board, whatever applicable are submitted by the Contractor to the Project Manager, WAPCOS.

CLAUSE 8: COMPLETION CERTIFICATE AND COMPLETION PLANS

Within ten days of the completion of the work, the contractor shall give notice of such completion to the Engineer-in-Charge and within thirty days of the receipt of such notice, the Engineer-in-Charge or his representative shall inspect the work with Project Manager, WAPCOS and if there is no defect in the work, shall furnish the contractor with a final certificate of completion, otherwise a provisional certificate of physical completion indicating defects (a) to be rectified by the contractor and/or (b) for which payment will be made at reduced rates, shall be issued. But no final certificate of completion shall be issued, nor shall the work be considered to be complete until the contractor shall have removed from the premises on which the work shall be executed all scaffolding, surplus materials, rubbish and all huts and sanitary arrangements required for his/their work people on the site in connection with the execution of the works as shall have been erected or constructed by the contractor(s) and cleaned off the dirt from all wood work, doors, windows, walls, floor or other parts of the building, in, upon, or about which the work is to be executed or of which he may have had possession for the purpose of the execution; thereof, and not until the work shall have been measured by the Engineer-in-Charge. If the contractor shall fail to comply with the requirements of this Clause as to removal of scaffolding, surplus materials and rubbish and all huts and sanitary arrangements as aforesaid and cleaning off dirt on or before the date fixed for the completion of work, the Engineer-in-Charge may at the expense of the contractor remove such scaffolding, surplus materials and rubbish etc., and dispose of the same as he thinks fit and clean off such dirt as aforesaid, and the contractor shall have no claim in respect of scaffolding or surplus materials as aforesaid except for any sum actually realized by the sale thereof.

The completion certificate shall be issued by Employer to the Contractor after successful handing/taking over by Principal Employer; submitting of **Occupational Certificates** issued by the local urban bodies/Municipal Corporation by contractor along with submission of all necessary NOC's/statutory approvals from all concerned departments such as local urban bodies, Fire Department, Electricity Board/Chief Electrical Inspector, Forest, Lift etc. of that area in accordance with Government norms to enable Principal Employer/Owner to occupy the project with all required services.

CLAUSE 8A : COMPLETION PLANS TO BE SUBMITTED BY THE CONTRACTOR

The contractor shall submit completion plans for Internal and External Civil, Electrical and Mechanical Services within thirty days of the completion of the work, provided that the service plans having been issued for execution, unless the contractor, by virtue of any other provision in the contract, is required to prepare such plans. The "As Built" Drawings and completion report shall be submitted by the Contractor within 30 days from the date of completion works in 3 sets.

In case, the contractor fails to submit the completion plan/drawings as aforesaid, he shall be liable to pay a sum of 0.25% (zero point two five percent) of Tendered value.

CLAUSE 9 : PAYMENT OF FINAL BILL

The final bill shall be submitted by the Contractor in the same manner as specified in interim bills within three months of physical completion of the work or within one month of the date of the final certificate of completion furnished by the Engineer-in- Charge whichever is earlier. No further claims shall be made by the Contractor after submission of the final bill and these shall be deemed to have been waived and extinguished.

CLAUSE 10A: MATERIALS TO BE PROVIDED BY CONTRACTOR

The contractor shall, at his own expense, provide all materials, required for the works.

The contractor shall, at his own expense and without delay, supply to the Project Manager, WAPCOS samples of materials to be used on the work and shall get these approved in advance. All such materials to be provided by the Contractor shall be in conformity with the specifications laid down or referred to in the contract. The contractor shall, if requested by the Engineer-in-Charge furnish proof, to the satisfaction of the Engineer-in-Charge that the materials so comply. The Project Manager, WAPCOS shall within thirty days of supply of samples or within such further period as he may require intimate to the Contractor in writing whether samples are approved by him or not. If samples are not approved, the Contractor shall forthwith arrange to supply to the Project Manager, WAPCOS for his approval, fresh samples complying with the specifications laid down in the contract. When materials are required to be tested in accordance with specifications, approval of the Engineer-in-Charge/ Principal Employer shall be issued after the test results are received.

The Contractor shall at his risk and cost submit the samples of materials to be tested or analyzed and shall not make use of or incorporate in the work any materials represented by the samples until the required tests or analysis have been made and materials finally accepted by the Engineer-in-Charge/ Principal Employer. The Contractor shall not be eligible for any claim or compensation either arising out of any delay in the work or due to any corrective measures required to be taken on account of and as a result of testing of materials.

The contractor shall, at his risk and cost, make all arrangements and shall provide all facilities as the Project Manager, WAPCOS may require for collecting, and preparing the required number of samples for such tests at such time and to such place or places as may be directed by the Project Manager, WAPCOS and bear all charges and cost of testing unless specifically provided for otherwise elsewhere in the contract or specifications. The Engineer-in- Charge or his authorized representative shall at all times have access to the works and to all workshops and places where work is being prepared or from where materials, manufactured articles or machinery are being obtained for the works and the contractor shall afford every facility and every assistance in obtaining the right to such access.

The Engineer-in-Charge or his authorized representative shall have full powers to require the removal from the premises of all materials which in his opinion are not in accordance with the specifications and

in case of default, the Engineer-in-Charge shall be at liberty to employ at the expense of the contractor, other persons to remove the same without being answerable or accountable for any loss or damage that may happen or arise to such materials. The Engineer-in-Charge or his authorized representative shall also have full powers to require other proper materials to be substituted thereof and in case of default, the Engineer-in-Charge or his authorized representative may cause the same to be supplied and all costs which may attend such removal and substitution shall be borne by the Contractor.

The Contractor shall at his own expense, provide a material testing lab at the site for conducting routine field tests. The lab shall be equipped at least with the testing equipment as specified in Contract.

If the Engineer-in-Charge or his authorized representative instructs the Contractors to carry out a test not specified in the Specification to check whether any work has a Defect. Such tests are to be carried out by the Contractor by deploying agencies and paying all the cost for such tests.

CLAUSE 10B :

(i) SECURED ADVANCE ON NON-PERISHABLE MATERIALS AND RECOVERY

The contractor, on signing an indenture in the form to be shall be entitled to be paid during the progress of the execution of the work up to 75% of the assessed value of any materials which are in the opinion of the Project Manager, WAPCOS non-perishable, non-fragile and non-combustible and are in accordance with the contract and which have been brought on the site in connection therewith and are adequately stored and/or protected against damage by weather or other causes but which have not at the time of advance been incorporated in the works. When materials on account of which an advance has been made under this sub-clause are incorporated in the work, the amount of such advance shall be recovered/ deducted from the next payment made under any of the clause or clauses of this contract.

Such secured advance shall also be payable on other items of perishable nature, fragile and combustible with the approval of the Engineer-in-Charge provided the contractor provides a comprehensive insurance cover for the full cost of such materials. The decision of the Engineer-in-Charge shall be final and binding on the contractor in this matter. No secured advance, shall however, be paid on high-risk materials such as ordinary glass, sand, petrol, diesel etc.

The secure Advance shall be recovered as per consumption of material from the contractor which secure advance is given to the contractor. If any value of secure advance is remaining to recover, then it will be fully recovered after completion of 80% work of the Tendered Value.

(ii) MOBILISATION ADVANCE

On request of contractor, the Employer shall make interest bearing advance payment for mobilization of labour, stores and workshops including camps, labour sheds, machineries and construction plant, etc. for preliminary and enabling Works, after the signing of Contract agreement to the extent of 10 (ten) per cent of the Tendered Value of an unconditional BG. Such BG shall remain effective until the advance payment has been fully repaid.

The aforesaid advance of 10 (ten) per cent shall be paid in two instalments, each of five per cent. The first one shall be paid on commencement of the work and on submission of unconditional BG in respect of the advance.

The second instalment shall be paid on certification by the engineer in charge for achieving a financial progress of 10 (ten) per cent of the Tendered Value, as also provision of a BG by the contractor for this part of the advance. Mobilisation expenditure mentioned herein shall not include the margin money and bank commission, and so on, paid by the contractor for procurement of BGs against performance security and mobilisation advance.

The request of contractor for aforesaid mobilization advance will be considered within 3 (three) months from the commencement of work.

(iii) INTEREST & RECOVERY OF MOBILISATION ADVANCE

The mobilization advance bears simple interest at the rate 10 % and shall be calculated from the date of payment to the date of recovery (365 days in a year) both days inclusive, on the outstanding amount of advance.

Before any installment of advance is released, the contractor shall execute a one single Bank Guarantee Bond from Scheduled Bank for the amount equal to 110% of the amount of mobilization advance and valid up to stipulated period of completion as mentioned in NIT. This (Bank Guarantee from Scheduled Bank for the amount equal to 110% of the balance amount of advance) shall be kept renewed from time to time to cover the balance amount and likely period of complete recovery.

Recovery of such sums advanced shall be made by the deduction from the contractor's bills commencing after first 10% of the gross value of the work is executed and paid, on pro-rata percentage basis to the gross value of the work billed beyond 10% in such a way that the entire advance is recovered by the time 80% of the gross value of the contract is executed and paid, together with interest due on the entire outstanding amount up to the date of recovery of the installment. Along with aforesaid condition of recovery of mobilization advance, if contractor wants to recover more or full mobilization advance from the interim bills, then accordingly mobilization advance may be recovered by Employer. The said request will be given by the contractor along with the interim bill to the Engineer-In-Charge. The Bank Guarantee will be returned after recovery of the mobilization advance against particular Bank guarantee.

CLAUSE 10C : PAYMENT ON ACCOUNT OF INCREASE IN PRICE / WAGES DUE TO STATUTORY ORDER – NOT APPLICABLE

The Contractor shall treat all materials obtained during excavation of the site for a work, etc. as Government property and same shall be disposed-off according to the instructions in writing issued by the Engineer-in-Charge.

CLAUSE 10D : DISMANTLED MATERIAL PROPERTY

The contractor shall treat all materials obtained during dismantling of a structure, excavation of the site for a work, etc. as WAPCOS/Government/Principal Employer property and such materials shall be disposed off to the best advantage of WAPCOS according to the instructions in writing issued by the Engineer-in-Charge or his authorized representative.

CLAUSE 11 : WORKS TO BE EXECUTED IN ACCORDANCE WITH SPECIFICATIONS, DRAWINGS, ORDERS ETC.

The Contractor shall execute the work as per the sequence submitted by Contractor and approved by Engineer-in-Charge from time to time so that all other items of the work to be executed by other agencies are completed progressively along with the main work.

The contractor shall execute the whole and every part of the work in the most substantial and workmanlike manner both as regards materials and otherwise in every respect in strict accordance with the specifications. The contractor shall also conform exactly, fully and faithfully to the design, drawings

and instructions in writing in respect of the work and the contractor shall be furnished free of charge one copy of the contract documents together with specifications, designs, drawings and instructions as are not included in the standard specifications or in any Bureau of Indian Standard or any other, published standard or code or, Schedule of Rates or any other printed publication referred to elsewhere in the contract.

The contractor shall comply with the provisions of the contract and with the care and diligence execute and maintain the works and provide all labour and materials, tools and plants including for measurements and supervision of all works, structural plans and other things of temporary or permanent nature required for such execution and maintenance in so far as the necessity for providing these, is specified or is reasonably inferred from the contract. The Contractor shall take full responsibility for adequacy, suitability and safety of all the works and methods of construction.

At least to 10% of prescribed Tests as per Central Public Works Department Manual/IS Codes of construction materials shall be carried out from the outside approved/NABL recognized Laboratory as may be approved by Engineer-In-Charge without any extra expenditure to Employer.

The Contractor shall establish a field test laboratory on the site with latest equipment's for carrying out field tests of construction materials and will maintain proper records of all the test results.

CLAUSE 12 : DEVIATIONS / VARIATIONS EXTENT AND PRICING

The Engineer-in-Charge shall have power (i) to make alteration in, omissions from, additions to, or substitutions for the original specifications, drawings, designs and instructions that may appear to him to be necessary or advisable during the progress of the work, and (ii) to omit a part of the works in case of non-availability of a portion of the site or for any other reasons and the contractor shall be bound to carry out the works in accordance with any instructions given to him in writing signed by the Engineer-in-Charge and such alterations, omissions, additions or substitutions shall form part of the contract as if originally provided therein and any altered, additional or substituted work which the contractor may be directed to do in the manner specified above as part of the works, shall be carried out by the contractor on the same conditions in all respects including price on which he agreed to do the main work except as hereafter provided.

12.1 The time for completion of the works shall, in the event of any deviations resulting in additional cost over the Tendered Value sum being ordered, be extended, if requested by the contractor, as follows:

- (i) In the proportion which the additional cost of the altered, additional or substituted work, bears to the original Tendered Value plus
- (ii) 25% of the time calculated in (i) above or such further additional time as may be considered reasonable by the Engineer-in-Charge.

12.2 Deviations, Extra Items, Substituted item and Pricing

- (a) **In the case of extra item(s)** (items that are completely new, and are in addition to the items contained in the contract), the contractor may within fifteen days of receipt of order or occurrence of the item(s) claim rates, supported by proper analysis, for the work and the Project Manager, WAPCOS shall within prescribed time limit of the receipt of the claims supported by analysis, after giving consideration to the analysis of the rates submitted by the contractor, determine the rates on the basis of the market rates and the contractor shall be paid in accordance with the rates so determined after approval of Engineer-in -charge.

- (b) **In the case of substituted items** (items that are taken up with partial substitution or in lieu of items of work in the contract), the rate for the agreement item (to be substituted) and substituted item shall also be determined in the manner as mentioned in the following para.
- If the market rate for the substituted item so determined is more than the market rate of the agreement item (to be substituted), the rate payable to the contractor for the substituted item shall be the rate for the agreement item (to be substituted) so increased to the extent of the difference between the market rates of substituted item and the agreement item (to be substituted).
 - If the market rate for the substituted item so determined is less than the market rate of the agreement item (to be substituted), the rate payable to the contractor for the substituted item shall be the rate for the agreement item (to be substituted) so decreased to the extent of the difference between the market rates of substituted item and the agreement item (to be substituted).
- (c) **In the case of contract items, substituted items, contract cum substituted items, which exceed the limits laid down in Special Conditions of Contract**, the contractor may within fifteen days of receipt of order or occurrence of the excess, claim revision of the rates, supported by proper analysis for the work in excess of the above mentioned limits, provided that if the rates so claimed are in excess of the rates specified in the schedule of quantities, the Project Manager, WAPCOS shall within prescribed time limit of receipt of the claims supported by analysis, after giving consideration to the analysis of the rates submitted by the contractor, determine the rates on the basis of the market rates and the contractor shall be paid in accordance with the rates so determined after approval of Engineer-in-charge.

The prescribed time limit for finalizing rates for Extra Item(s), Substitute Item(s) and Deviated Quantities of contract items is within 45 days after submission of proposal by the contractor without observation of the Engineer-in-Charge or his authorized representative.

12.3 Any operation incidental to or necessarily has to be in contemplation of tenderer while filing tender, or necessary for proper execution of the item included in the Schedule of quantities or in the schedule of rates mentioned above, whether or not, specifically indicated in the description of the item and the relevant specifications, shall be deemed to be included in the rates quoted by the tenderer or the rate given in the said schedule of rates, as the case may be. Nothing extra shall be admissible for such operations.

CLAUSE 13: FORECLOSURE OF CONTRACT DUE TO ABANDONMENT OR REDUCTION IN SCOPE OF WORK

If at any time after acceptance of the tender, Engineer-in-charge shall decide to abandon or reduce the scope of the works for any reason whatsoever and hence not require the whole or any part of the works to be carried out, the Engineer-in-Charge shall give notice in writing to that effect to the contractor and the contractor shall act accordingly in the matter. The contractor shall have no claim to any payment of compensation or otherwise whatsoever, on account of any profit or advantage which he might have derived from the execution of the works in full but which he did not derive in consequence of the foreclosure of the whole or part of the works.

The contractor shall be paid at contract rates, full amount for works executed at site and, in addition, a reasonable amount as certified by the Engineer-in-Charge for the items hereunder mentioned which could not be utilized on the work to the full extent in view of the foreclosure;

- (i) Any expenditure incurred on preliminary site work, e.g. temporary access roads, temporary labour huts, staff quarters and site office; storage accommodation and water storage tanks.
- (ii) Employer shall have the option to take over contractor's materials or any part thereof either brought to site or of which the contractor is legally bound to accept delivery from suppliers (for

incorporation in or incidental to the work). For materials taken over or to be taken over by WAPCOS, cost of such materials as detailed by Engineer-in-Charge shall be paid. The cost shall, however, take into account purchase price, cost of transportation and deterioration or damage which may have been caused to materials whilst in the custody of the contractor.

- (iii) Reasonable compensation for transfer of T & P from site to contractor's permanent stores or to his other works, whichever is less. If T & P are not transported to either of the said places, no cost of transportation shall be payable.

The contractor shall, if required by the Engineer-in-Charge, furnish to him, books of account, wage books, time sheets and other relevant documents and evidence as may be necessary to enable him to certify the reasonable amount payable under this condition.

The reasonable amount of items on (i), (iv) and (v) above shall not be in excess of 2% of the cost of the work remaining incomplete on the date of closure, i.e. total stipulated cost of the work as per accepted tender less the cost of work actually executed under the contract and less the cost of contractor's materials at site taken over by the WAPCOS as per item (ii) above. Provided always that against any payments due to the contractor on this account or otherwise, the Engineer-in-Charge shall be entitled to recover or be credited with any outstanding balances due from the contractor for advance paid in respect of any tool, plants and materials and any other sums which at the date of termination were recoverable by the WAPCOS from the contractor under the terms of the contract.

In the event of action being taken under Clause 13 to reduce the scope of work, the Contractor may furnish fresh Performance Security on the same conditions, in the same manner and at the same rate for the balance tendered value and initially valid up to the extended date of completion or stipulated date of completion if no extension has been granted plus minimum 60 days beyond that. Wherever such a fresh Performance Security is furnished by the Contractor the Engineer-in-Charge may return the previous Performance Security.

CLAUSE 14 : CARRYING OUT PART WORK AT RISK & COST OF CONTRACTOR

If contractor:

- (i) At any time makes default during currency of work or does not execute any part of the work with due diligence and continues to do so even after a notice in writing of 7 days in this respect from the Engineer-in-Charge; or
- (ii) Commits default in complying with any of the terms and conditions of the contract and does not remedy it or takes effective steps to remedy it within 7 days even after a notice in writing is given in that behalf by the Engineer-in-Charge; or
Fails to complete the work(s) or items of work with individual dates of completion, on or before the date(s) so determined, and does not complete them within the period specified in the notice given in writing in that behalf by the Engineer-in-Charge.
- (iii) The Engineer-in-Charge without invoking action under clause 3 may, without prejudice to any other right or remedy against the contractor which have either accrued or accrue thereafter to WAPCOS, by a notice in writing to take the part work / part incomplete work of any item(s) out of his hands and shall have powers to:
 - (a) Take possession of the site and any materials, constructional plant, implements, stores, etc., thereon; and/or
 - (b) Carry out the part work / part incomplete work of any item(s) by any means at the risk and cost of the contractor.

The Engineer-in-Charge shall determine the amount, if any, is recoverable from the contractor for completion of the part work/ part incomplete work of any item(s) taken out of his hands and execute at the risk and cost of the contractor, the liability of contractor on account of loss or damage suffered by WAPCOS because of action under this clause shall not exceed 10% of the Contract Price.

In determining the amount, credit shall be given to the contractor with the value of work done in all respect in the same manner and at the same rate as if it had been carried out by the original contractor under the terms of his contract, the value of contractor's materials taken over and incorporated in the work and use of plant and machinery belonging to the contractor.

The certificate of the Engineer-in-Charge as to the value of work done shall be final and conclusive against the contractor provided always that action under this clause shall only be taken after giving notice in writing to the contractor. Provided also that if the expenses incurred by the WAPCOS are less than the amount payable to the contractor at his agreement rates, the difference shall not be payable to the contractor.

Any excess expenditure incurred or to be incurred by WAPCOS in completing the part work/ part incomplete work of any item(s) or the excess loss of damages suffered or may be suffered by WAPCOS as aforesaid after allowing such credit shall without prejudice to any other right or remedy available to WAPCOS in law or per as agreement be recovered from any money due to the contractor on any account, and if such money is insufficient, the contractor shall be called upon in writing and shall be liable to pay the same within 30 days.

If the contractor fails to pay the required sum within the aforesaid period of 30 days, the Engineer-in-Charge shall have the right to sell any or all of the contractors' unused materials, constructional plant, implements, temporary building at site etc. and adjust the proceeds of sale thereof towards the dues recoverable from the contractor under the contract and if thereafter there remains any balance outstanding, it shall be recovered in accordance with the provisions of the contract.

In the event of above course being adopted by the Engineer-in-Charge, the contractor shall have no claim to compensation for any loss sustained by him by reason of his having purchased or procured any materials or entered into any engagements or made any advance on any account or with a view to the execution of the work or the performance of the contract.

CLAUSE 15 : SUSPENSION OF WORK

- (i) The contractor shall, on receipt of the order in writing of the Engineer-in-Charge, (whose decision shall be final and binding on the contractor) suspend the progress of the works or any part thereof for such time and in such manner as the Engineer-in-Charge may consider necessary so as not to cause any damage or injury to the work already done or endanger the safety thereof for any of the following reasons:
 - (a) on account of any default on the part of the contractor or;
 - (b) for proper execution of the works or part thereof for reasons other than the default of the contractor; or
 - (c) for safety of the works or part thereof.

The contractor shall, during such suspension, properly protect and secure the works to the extent necessary and carry out the instructions given in that behalf by the Engineer-in-Charge.

- (ii) If the suspension is ordered for reasons (b) and (c) in sub-para (i) above:
 - (a) the contractor shall be entitled to an extension of time equal to the period of every such suspension PLUS 25%, for completion of the item or group of items of work for which a separate period of completion is specified in the contract and of which the suspended work forms a part, and;
 - (b) If the total period of all such suspensions in respect of an item or group of items or work for which a separate period of completion is specified in the contract exceeds thirty days, the contractor shall, in addition, be entitled to such compensation as the Engineer-in-Charge may consider reasonable in respect of salaries and/or wages paid by the contractor to his

employees and labour at site, remaining idle during the period of suspension, adding thereto 2% to cover indirect expenses of the contractor provided the contractor submits his claim supported by details to the Engineer-in-Charge within fifteen days of the expiry of the period of 30 days.

- (iii) If the works or part thereof is suspended on the orders of the Engineer-in-Charge for more than three months at a time, except when suspension is ordered for reason (a) in subpara (i) above, the contractor may after receipt of such order serve a written notice on the Engineer-in-Charge requiring permission within fifteen days from receipt by the Engineer-in-Charge of the said notice, to proceed with the work or part thereof in regard to which progress has been suspended and if such permission is not granted within that time, the contractor, if he intends to treat the suspension, where it affects only a part of the works as an omission of such part by WAPCOS or where it affects whole of the works, as an abandonment of the works by WAPCOS, shall within ten days of expiry of such period of 15 days give notice in writing of his intention to the Engineer-in-Charge. In the event of the contractor treating the suspension as an abandonment of the contract by WAPCOS, he shall have no claim to payment of any compensation on account of any profit or advantage which he might have derived from the execution of the work in full but which he could not derive in consequence of the abandonment. He shall, however, be entitled to such compensation, as the Engineer-in-Charge may consider reasonable, in respect of salaries and/or wages paid by him to his employees and labour at site, remaining idle in consequence adding to the total thereof 2% to cover indirect expenses of the contractor provided the contractor submits his claim supported by details to the Engineer-in-Charge within 30 days of the expiry of the period of 3 months.

CLAUSE 16 : ACTION IN CASE WORK NOT DONE AS PER SPECIFICATIONS

All works under or in course of execution or executed in pursuance of the contract, shall at all times be open and accessible to the inspection and supervision of the Project Manager, WAPCOS and all the superior officers, officer of the Quality Assurance Unit of the WAPCOS or any organization engaged by the WAPCOS for Quality Assurance and of the Chief Technical Examiner's Office, and the contractor shall, at all times, during the usual working hours and at all other times at which reasonable notice of the visit of such officers has been given to the contractor, either himself be present to receive orders and instructions or have a responsible agent duly accredited in writing, present for that purpose. Orders given to the Contractor's agent shall be considered to have the same force as if they had been given to the contractor himself.

If it shall appear to the Engineer-in-charge or his authorized subordinates incharge of the work or to the Engineer-in-charge of Quality Assurance or Project Manager, WAPCOS or his subordinate officers or the officers of the organization engaged by the WAPCOS for Quality Assurance or to the Chief Technical Examiner or his subordinate officers, that any work has been executed with unsound, imperfect, or unskillful workmanship, or with materials or articles provided by him for the execution of the work which are unsound or of a quality inferior to that contracted or otherwise not in accordance with the contract, the contractor shall, on demand in writing which shall be made within twelve months (six months in the case of work costing Rs. 10 Lac and below except road work) of the completion of the work from the Engineer-in-Charge specifying the work, materials or articles complained of notwithstanding that the same may have been passed, certified and paid for forthwith rectify, or remove and reconstruct the work so specified in whole or in part, as the case may require or as the case may be, remove the materials or articles so specified and provide other proper and suitable materials or articles at his own charge and cost. In the event of the failing to do so within a period specified by the Engineer-in- Charge in his demand aforesaid, then the contractor shall be liable to pay compensation at the same rate as under clause 2 of the contract (for non-completion of the work in time) for this default.

In such case the Engineer-in-Charge may not accept the item of work at the rates applicable under the contract but may accept such items at reduced rates as the authority specified in Special Conditions of Contract may consider reasonable during the preparation of on account bills or final bill if the item is so acceptable without detriment to the safety and utility of the item and the structure or he may reject the work outright without any payment and/or get it and other connected and incidental items rectified, or removed and re-executed at the risk and cost of the contractor. Decision of the Engineer-in-Charge to be conveyed in writing in respect of the same will be final and binding on the contractor.

CLAUSE 17: CONTRACTOR LIABLE FOR DAMAGES, DEFECTS DURING DEFECT LIABILITY PERIOD

The Warranty (on site)/Defect Liability Period shall be 12 (Twelve) Months.

The Warranty/Defect Liability Period shall commence from the date of issue of the Taking Over Certificate by Principal Employer or issue of Completion Certificate by Principal Employer or agreed date of start of Defect Liability Period by the Principal Employer whichever is later. The Warranty period of equipments/items shall be provided as per the manufacturer norms or upto end of Defect liability period whichever is more. When the equipment is under Warranty/Defect Liability Period, it shall be the sole responsibility of the Contractor/Supplier to rectify defect of equipment, spare parts, replacement equipment as deemed necessary by the Employer/Owner and install the same without any cost implications to Employer/ Owner.

If the contractor or his working people or servants shall break, deface, injure or destroy any part of building in which they may be working, or any building, road, road kerb, fence, enclosure, water pipe, cables, drains, electric or telephone post or wires, trees, grass or grassland, or cultivated ground contiguous to the premises on which the work or any part is being executed, or if any damage shall happen to the work while in progress, from any cause whatever or if any defect, shrinkage or other faults appear in the work within twelve months (six months in the case of work costing Rs. Ten lacs and below except road work) after a certificate final or otherwise of its completion shall have been given by the Engineer-in- Charge as aforesaid arising out of defect or improper materials or workmanship the contractor shall upon receipt of a notice in writing on that behalf make the same good at his own expense or in default the Engineer-in-Charge cause the same to be made good by other workmen and deduct the expense from any sums that may be due or at any time thereafter may become due to the contractor, or from his security deposit or the proceeds of sale thereof or of a sufficient portion thereof.

CLAUSE 18 : CONTRACTOR SUPPLY TOOLS & PLANTS ETC.

The contractor shall provide at his own cost all materials, machinery, tools & plants as specified in tender. In addition to this, appliances, implements, other plants, ladders, cordage, tackle, scaffolding and temporary works required for the proper execution of the work, whether original, altered or substituted and whether included in the specifications or other documents forming part of the contract or referred to in these conditions or not, or which may be necessary for the purpose of satisfying or complying with the requirements of the Engineer-in-Charge as to any matter as to which under these conditions he is entitled to be satisfied, or which he is entitled to require together with carriage therefore to and from the work. The contractor shall also supply without charge the requisite number of persons with the means and materials, necessary for the purpose of setting out works, and counting, weighing and assisting the measurement for examination at any time and from time to time of the work or materials. Failing his so doing, the same may be provided by the Engineer-in-Charge at the expense of the contractor and the expenses may be deducted, from any money due to the contractor, under this contract or otherwise and/or from his security deposit or the proceeds of sale thereof, or of a sufficient portions thereof.

CLAUSE 18A : RECOVERY OF COMPENSATION PAID TO WORKMEN

In every case in which by virtue of the provisions sub-section (1) of Section 12, of the Workmen's Compensation Act, 1923, WAPCOS is obliged to pay compensation to a workman employed by the contractor, in execution of the works, WAPCOS will recover from the contractor, the amount of the compensation so paid; and, without prejudice to the rights of the WAPCOS under sub-section (2) of Section 12, of the said Act, WAPCOS shall be at liberty to recover such amount or any part thereof by deducting it from the security deposit or from any sum due by WAPCOS to the contractor whether under this contract or otherwise. WAPCOS shall not be bound to contest any claim made against it under sub-section (1) of Section 12, of the said Act, except on the written request of the contractor and upon his giving to WAPCOS full security for all costs for which WAPCOS might become liable in consequence of contesting such claim.

CLAUSE 18B: ENSURING PAYMENT AND AMENITIES TO WORKERS, IF CONTRACTOR FAILS

In every case in which by virtue of the provisions of the Contract Labour (Regulation and Abolition) Act, 1970, and of the Contract Labour (Regulation and Abolition) Central Rules, 1971, WAPCOS is obliged to pay any amounts of wages to a workman employed by the contractor in execution of the works, or to incur any expenditure in providing welfare and health amenities required to be provided under the above said Act and the rules under Clause 19H or under the C.P.W.D. Contractor's Labour Regulations, or under the Rules framed by Government from time to time for the protection of health and sanitary arrangements for workers employed by C.P.W.D. Contractors, WAPCOS will recover from the contractor, the amount of wages so paid or the amount of expenditure so incurred; and without prejudice to the rights of the WAPCOS under sub-section(2) of Section 20, and sub-section (4) of Section 21, of the Contract Labour (Regulation and Abolition) Act, 1970, WAPCOS shall be at liberty to recover such amount or any part thereof by deducting it from the security deposit or from any sum due by WAPCOS to the contractor whether under this contract or otherwise WAPCOS shall not be bound to contest any claim made against it under sub-section (1) of Section 20, sub-section (4) of Section 21, of the said Act, except on the written request of the contractor and upon his giving to the WAPCOS full security for all costs for which WAPCOS might become liable in contesting such claim.

CLAUSE 19 : LABOUR LAWS TO BE COMPLIED BY CONTRACTOR

The contractor shall obtain a valid license under the Contract Labour (R&A) Act, 1970, and the Contract Labour (Regulation and Abolition) Central Rules, 1971, before the commencement of the work, and continue to have a valid license until the completion of the work.

The contractor shall also comply with provisions of the Inter-State Migrant Workmen (Regulation of Employment and Conditions of Service) Act, 1979.

The contractor shall also abide by the provisions of the Child Labour (Prohibition and Regulation) Act, 1986.

The contractor shall also comply with the provisions of the building and other Construction Workers (Regulation of Employment & Conditions of Service) Act, 1996 and the building and other Construction Workers Welfare Cess Act, 1996.

Any failure to fulfill these requirements shall attract the penal provisions of this contract arising out of the resultant non-execution of the work

CLAUSE 19A

No labour below the age of fourteen years shall be employed on the work.

CLAUSE 19B : PAYMENT OF WAGES

- i. The contractor shall pay to labour employed by him either directly or through subcontractors, wages not less than fair wages as per the provisions of the Contract Labour (Regulation and Abolition) Act, 1970 and the contract Labour (Regulation and Abolition) Central Rules, 1971, wherever applicable.
- ii. The contractor shall, notwithstanding the provisions of any contract to the contrary, cause to be paid fair wage to labour indirectly engaged on the work, including any labour engaged by his sub-contractors in connection with the said work, as if the labour had been immediately employed by him.
- iii. In respect of all labour directly or indirectly employed in the works for performance of the contractor's part of this contract, the contractor shall comply with or cause to be complied with the Contractor's Labour Regulations made by WAPCOS from time to time in regard to payment of wages, wage period, deductions from wages recovery of wages not paid and deductions unauthorisedly made, maintenance of wage books or wage slips, publication of scale of wages and other terms of employment, inspection and submission of periodical returns and all other matters of the like nature or as per the provisions of the Contract Labour (Regulation and Abolition) Act, 1970, and the Contract Labour (Regulation and Abolition) Central Rules, 1971, wherever applicable.
- iv. (a) The Engineer-in-Charge concerned shall have the right to deduct from the moneys due to the contractor any sum required or estimated to be required for making good the loss suffered by a worker or workers by reason of non-fulfilment of the conditions of the contract for the benefit of the workers, non-payment of wages or of deductions made from his or their wages which are not justified by their terms of the contract or non-observance of the Regulations.

(b) Under the provision of Minimum Wages (Central) Rules, 1950, the contractor is bound to allow to the labours directly or indirectly employed in the works one day rest for 6 days continuous work and pay wages at the same rate as for duty. In the event of default, the Engineer-in-Charge shall have the right to deduct the sum or sums not paid on account of wages for weekly holidays to any labours and pay the same to the persons entitled thereto from any money due to the contractor by the Engineer-in-Charge concerned.

In the case of Union Territory of Delhi, however, as the all inclusive minimum daily wages fixed under Notification of the Delhi Administration No.F.12(162)MWO/DAB/ 43884-91, dated 31-12-1979 as amended from time to time are inclusive of wages for the weekly day of rest, the question of extra payment for weekly holiday would not arise.
- v. The contractor shall comply with the provisions of the Payment of Wages Act, 1936, Minimum Wages Act, 1948, Employees Liability Act, 1938, Workmen's Compensation Act, 1923, Industrial Disputes Act, 1947, Maternity Benefits Act, 1961, and the Contractor's Labour (Regulation and Abolition) Act 1970, or the modifications thereof or any other laws relating thereto and the rules made thereunder from time to time.
- vi. The contractor shall indemnify and keep indemnified WAPCOS against payments to be made under and for the observance of the laws aforesaid without prejudice to his right to claim indemnity from his sub-contractors.
- vii. The laws aforesaid shall be deemed to be a part of this contract and any breach thereof shall be deemed to be a breach of this contract.
- viii. Whatever is the minimum wage for the time being, or if the wage payable is higher than such wage, such wage shall be paid by the contractor to the workmen directly without the intervention of Jamadar and that Jamadar shall not be entitled to deduct or recover any amount from the minimum wage payable to the workmen as and by way of commission or otherwise.

- ix. The contractor shall ensure that no amount by way of commission or otherwise is deducted or recovered by the Jamadar from the wage of workmen.

CLAUSE 19C

In respect of all labour directly or indirectly employed in the work for the performance of the contractor's part of this contract, the contractor shall at his own expense arrange for the safety provisions as per Safety Code framed from time to time and shall at his own expense provide for all facilities in connection therewith. In case the contractor fails to make arrangement and provide necessary facilities as aforesaid, he shall be liable to pay a penalty of Rs.500/- for each default and in addition, the Engineer-in-Charge shall be at liberty to make arrangement and provide facilities as aforesaid and recover the costs incurred in that behalf from the contractor.

CLAUSE 19 D

The contractor shall submit by the 4th and 19th of every month, to the Engineer-in-Charge, a true statement showing in respect of the second half of the preceding month and the first half of the current month respectively:-

- (1) The number of labourers employed by him on the work,
- (2) Their working yours,
- (3) The wages paid to them,
- (4) The accidents that occurred during the said fortnight showing the circumstances under which they happened and the extent of damage and injury caused by them, and
- (5) The number of female workers who have been allowed maternity benefit according to Clause 19F and the amount paid to them.

Failing which the contractor shall be liable to pay to WAPCOS, a sum not exceeding Rs.500/- for each default or materially incorrect statement. The decision of the Engineer-In-Charge shall be final in deducting from any bill due to the contractor; the amount levied as fine and be binding on the contractor.

CLAUSE 19 E

In respect of all labour directly or indirectly employed in the works for the performance of the contractor's part of this contract, the contractor shall comply with or cause to be complied with all the rules framed by Government from time to time for the protection of health and sanitary arrangements for workers employed by the WAPCOS and its contractors.

CLAUSE 19 F

Leave and pay during leave shall be regulated as follows:-

1. **Leave :**
 - (i) in the case of delivery - maternity leave not exceeding 8 weeks, 4 weeks up to and including the day of delivery and 4 weeks following that day,
 - (ii) in the case of miscarriage - upto 3 weeks from the date of miscarriage.
2. **Pay :**
 - (i) in the case of delivery - leave pay during maternity leave will be at the rate of the women's average daily earnings, calculated on total wages earned on the days when full time work was done during a period of three months immediately preceding the date on which she gives notice that she expects to be confined or at the rate of Rupee one only a day whichever is greater.
 - (ii) in the case of miscarriage - leave pay at the rate of average daily earning calculated on the total wages earned on the days when full time work was done during a period of three months immediately preceding the date of such miscarriage.
3. Conditions for the grant of Maternity Leave:

No maternity leave benefit shall be admissible to a woman unless she has been employed for a total period of not less than six months immediately preceding the date on which she proceeds on leave.

4. The contractor shall maintain a register of Maternity (Benefit) in the Prescribed Form as shown in Appendix -I and II, and the same shall be kept at the place of work.

CLAUSE 19 G

In the event of the contractor(s) committing a default or breach of any of the provisions of the WAPCOS, Contractor's Labour Regulations and Model Rules for the protection of health and sanitary arrangements for the workers as amended from time to time or furnishing any information or submitting or filing any statement under the provisions of the above Regulations and' Rules which is materially incorrect, he/they shall, without prejudice to any other liability, pay to the Government a sum not exceeding Rs.500/- for every default, breach or furnishing, making, submitting, filing such materially incorrect statements and in the event of the contractor(s) defaulting continuously in this respect, the penalty may be enhanced to Rs.500/- per day for each day of default subject to a maximum of 5 per cent of the estimated cost of the work put to tender. The decision of the Engineer-in-Charge shall be final and binding on the parties.

Should it appear to the Engineer-in-Charge that the contractor(s) is/are not properly observing and complying with the provisions of the Labour Regulations and Model Rules and the provisions of the Contract Labour (Regulation and Abolition) Act 1970, and the Contract Labour (R& A) Central Rules 1971, for the protection of health and sanitary arrangements for work-people employed by the contractor(s) (hereinafter referred as "the said Rules") the Engineer-in-Charge shall have power to give notice in writing to the contractor(s) requiring that the said Rules be complied with and the amenities prescribed therein be provided to the work-people within a reasonable time to be specified in the notice. If the contractor(s) shall fail within the period specified in the notice to comply with and/observe the said Rules and to provide the amenities to the work-people as aforesaid, the Engineer-in-Charge shall have the power to provide the amenities hereinbefore mentioned at the cost of the contractor(s). The contractor(s) shall erect, make and maintain at his/their own expense and to approved standards all necessary huts and sanitary arrangements required for his/their work-people on the site in connection with the execution of the works, and if the same shall not have been erected or constructed, according to approved standards, the Engineer-in-Charge shall have power to give notice in writing to the contractor(s) requiring that the said huts and sanitary arrangements be remodelled and/or reconstructed according to approved standards, and if the contractor(s) shall fail to remodel or reconstruct such huts and sanitary arrangements according to approved standards within the period specified in the notice, the Engineer-in-Charge shall have the power to remodel or reconstruct such huts and sanitary arrangements according to approved standards at the cost of the contractor(s).

CLAUSE 19 H

The contractor(s) shall at his/their own cost provide his/their labour with a sufficient number of huts (hereinafter referred to as the camp) of the following specifications on a suitable plot of land to be approved by the Engineer-in-Charge.

- (i) (a) The minimum height of each hut at the eaves level shall be 2.10m (7 ft.) and the floor area to be provided will be at the rate of 2.7 sq.m. (30 sq.ft.) for each member of the worker's family staying with the labourer.
- (b) The contractor(s) shall in addition construct suitable cooking places having a minimum area of 1.80m x 1.50m (6'x5') adjacent to the hut for each family.
- (c) The contractor(s) shall also construct temporary latrines and urinals for the use of the labourers each on the scale of not less than four per each one hundred of the total strength, separate latrines and urinals being provided for women.

- (d) The contractor(s) shall construct sufficient number of bathing and washing places, one unit for every 25 persons residing in the camp. These bathing and washing places shall be suitably screened.
- (ii) (a) All the huts shall have walls of sun-dried or burnt-bricks laid in mud mortar or other suitable local materials as may be approved by the Engineer-in-Charge. In case of sun-dried bricks, the walls should be plastered with mud gobri on both sides. The floor may be kutcha but plastered with mud gobri and shall be at least 15 cm (6") above the surrounding ground. The roofs shall be laid with thatch or any other materials as may be approved by the Engineer-in-Charge and the contractor shall ensure that throughout the period of their occupation, the roofs remain water-tight.
 - (b) The contractor(s) shall provide each hut with proper ventilation.
 - (c) All doors, windows, and ventilators shall be provided with suitable leaves for security purposes.
 - (d) There shall be kept an open space of at least 7.2m (8 yards) between the rows of huts which may be reduced to 6m (20 ft.) according to the availability of site with the approval of the Engineer-in-Charge. Back to back construction will be allowed
- (iii) **Water Supply** - The contractor(s) shall provide adequate supply of water for the use of labourers. The provisions shall not be less than two gallons of pure and wholesome water per head per day for drinking purposes and three gallons of clean water per head per day for bathing and washing purposes. Where piped water supply is available, supply shall be at stand posts and where the supply is from wells or river, tanks which may be of metal or masonry, shall be provided. The contractor(s) shall also at his/ their own cost make arrangements for laying pipe lines for water supply to his/ their labour camp from the existing mains wherever available, and shall pay all fees and charges therefore.
- (iv) The site selected for the camp shall be high ground, removed from jungle.
- (v) **Disposal of Excreta** - The contractor(s) shall make necessary arrangements for the disposal of excreta from the latrines by trenching or incineration which shall be according to the requirements laid down by the Local Health Authorities. If trenching or incineration is not allowed, the contractor(s) shall make arrangements for the removal of the excreta through the Municipal Committee/authority and inform it about the number of labourers employed so that arrangements may be made by such Committee/authority for the removal of the excreta. All charges on this account shall be borne by the contractor and paid direct by him to the Municipality/authority. The contractor shall provide one sweeper for every eight seats in case of dry system.
- (vi) **Drainage** - The contractor(s) shall provide efficient arrangements for draining away sullage water so as to keep the camp neat and tidy.
- (vii) The contractor(s) shall make necessary arrangements for keeping the camp area sufficiently lighted to avoid accidents to the workers.
- (viii) **Sanitation** - The contractor(s) shall make arrangements for conservancy and sanitation in the labour camps according to the rules of the Local Public Health and Medical Authorities.

CLAUSE 19 I

The Engineer-in-Charge may require the contractor to dismiss or remove from the site of the work any person or persons in the contractors' employ upon the work who may be incompetent or misconduct himself and the contractor shall forthwith comply with such requirements. In respect of

maintenance/repair or renovation works etc. where the labour have an easy access to the individual houses, the contractor shall issue identity cards to the labourers, whether temporary or permanent and he shall be responsible for any untoward action on the part of such labour.

CLAUSE 19J

It shall be the responsibility of the contractor to see that the building under construction is not occupied by anybody unauthorisedly during construction, and is handed over to the Engineer-in-Charge with vacant possession of complete building. If such building though completed is occupied illegally, then the Engineer-in-Charge shall have the option to refuse to accept the said building/buildings in that position. Any delay in acceptance on this account will be treated as the delay in completion and for such delay, a levy upto 5% of Contract Price of work may be imposed by the WAPCOS whose decision shall be final both with regard to the justification and quantum and be binding on the contractor.

However, Employer, through a notice, may require the contractor to remove the illegal occupation any time on or before construction and delivery.

CLAUSE 19K : Employment of Skilled / Semi Skilled Workers

The contractor shall, at all stages of work, deploy skilled/semi skilled tradesmen who are qualified and possess certificate in particular trade from Industrial Training Institute/National Institute of construction Management and Research (NICMAR)/ National Academy of Construction, CIDC or any similar reputed and recognized Institute managed/ certified by State/Central Government. The number of such qualified tradesmen shall not be less than 20% of total skilled/semi skilled workers required in each trade at any stage of work. The contractor shall submit number of man days required in respect of each trade, its scheduling and the list of qualified tradesmen along with requisite certificate from recognized Institute to Engineer-in-charge for approval. Notwithstanding such approval, if the tradesmen are found to have inadequate skill to execute the work of respective trade, the contractor shall substitute such tradesmen within two days of written notice from Engineer-in-Charge. Failure on the part of contractor to obtain approval of Engineer-in-Charge or failure to deploy qualified tradesmen will attract a compensation to be paid by contractor at the rate of Rs. 100 per such tradesman per day. Decision of Engineer-in-charge as to whether particular tradesman possesses requisite skill and amount of compensation in case of default shall be final and binding.

Provided always, that the provisions of this clause, shall not be applicable for works with estimated cost put to tender being less than Rs. 5 crores.

For work costing more than Rs. 10 Crores, and upto Rs. 50 Crores, the Contractor shall arrange on site training as per National Skill Development Corporation (NSDC) norms for at least 20% of the unskilled workers engaged in the project in co-ordination with the Employer & National Skill Development Corporation (NSDC) for certification at the level of skilled/semi-skilled tradesmen.

For works costing more than Rs. 50 Crores, the Contractor shall arrange on site training as per National Skill Development Corporation (NSDC) norms for at least 30% of the unskilled worker engaged in the project in co-ordination with the Employer & National Skill Development Corporation (NSDC) for certification at the level of skilled/semi-skilled tradesmen. The cost of such training as stated above shall be borne by the Government. The necessary space and workers shall be provided by the Contractor and no claim what so ever shall be entertained.

CLAUSE 20 : MINIMUM WAGES ACT TO BE COMPLIED WITH

The contractor shall comply with all the provisions of the Minimum Wages Act, 1948, and Contract Labour (Regulation and Abolition) Act, 1970, amended from time to time and rules framed thereunder and other labour laws affecting contract labour that may be brought into force from time to time.

CLAUSE 21 : WORK NOT TO BE SUBLET/ACTION IN CASE OF INSOLVENCY

The contract shall not be assigned or sublet without the written approval of the Engineer-in Charge. And if the contractor shall assign or sublet his contract, or attempt to do so, or become insolvent or commence any insolvency proceedings or make any composition with his creditors or attempt to do so, or if any bribe, gratuity, gift, loan, perquisite, reward or advantage pecuniary or otherwise, shall either directly or indirectly, be given, promised or offered by the contractor, or any of his servants or agent to any public officer or person in the employ of WAPCOS in any way relating to his office or employment, or if any such officer or person shall become in any way directly or indirectly interested in the contract, the Engineer-in-Charge on behalf of the WAPCOS shall have power to adopt the course specified in Clause 3 hereof in the interest of WAPCOS and in the event of such course being adopted, the consequences specified in the said Clause 3 shall ensue.

CLAUSE 22

All sums payable by way of compensation under any of these conditions shall be considered as reasonable compensation to be applied to the use of WAPCOS without reference to the actual loss or damage sustained and whether or not any damage shall have been sustained.

CLAUSE 23 : CHANGES IN FIRM'S CONSTITUTION TO BE INTIMATED

Where the contractor is a partnership firm, the previous approval in writing of the Engineer-in-Charge shall be obtained before any change is made in the constitution of the firm. Where the contractor is an Proprietor Firm, such approval as aforesaid shall likewise be obtained before the contractor enters into any partnership agreement where under the partnership firm would have the right to carry out the works hereby undertaken by the contractor. If previous approval as aforesaid is not obtained, the contract shall be deemed to have been assigned in contravention of Clause 21 hereof and the same action may be taken, and the same consequences shall ensue as provided in the said Clause 21.

CLAUSE 24: LIFE CYCLE COST

The contractor shall be responsible for safety, quality and soundness of the buildings including structural elements beyond maintenance period. The contractor shall have obligation to rectify such defects minimum up to 5 (five) years from the date of completion of work. The defects have to be rectified within a reasonable time not exceeding forty five days after issue of notice by Engineer- in- Charge.If contractor does not take corrective action within 45 days, then action for debaring of the agency shall be taken by the appropriate authority.

CLAUSE 25 : SETTLEMENT OF DISPUTES & ARBITRATION

25.1 Settlement of Disputes

Except where otherwise provided in the contract, all questions and disputes relating to the meaning of the specifications, design, drawings and instructions here-in before mentioned and as to the quality of workmanship or materials used on the work or as to any other question, claim, right, matter or thing whatsoever in any way arising out of or relating to the contract, designs, drawings, specifications, estimates, instructions, orders or these conditions or otherwise concerning the works or the execution or failure to execute the same whether arising during the progress of the work or after the cancellation, termination, completion or abandonment thereof shall be dealt with as mentioned hereinafter:

- I. If the Contractor considers any work demanded of him to be outside the requirements of the Contract, or disputes any drawings, record or decision given in writing by the Engineer-in-Charge on any matter in connection with or arising out of the Contract or carrying out of the work, to be unacceptable, he shall promptly within 15 days request Engineer-in-Charge in writing for

- written instruction or decision. Thereupon, the Engineer-in-Charge shall give his written instructions or decision within a period of one month from the receipt of the Contractor's letter.
- II. In case the Contractor is not satisfied with the decision of Engineer-in-Charge, he may proceed for arbitration as detailed in Clause 25.2 hereinafter.
 - III. It is a term of Contract that each party invoking arbitration must exhaust the aforesaid mechanism of settlement of claims/disputes prior to invoking arbitration.
 - IV. Performance of this Agreement/ Contract shall continue during arbitration proceedings or any other dispute resolution mechanism pursuant to Clause 25.2. No payment due or payable by the Employer shall be withheld on account of pending reference to the arbitration or other dispute resolution mechanism except to the extent that such payment of dispute.

25.2 Arbitration

Any dispute, controversy of claims arising out of or relating to this Agreement or the breach, termination or invalidity thereof, shall be settled through following mechanism:

- a. Firstly, the aggrieved party shall write a letter to the other party detailing its grievances and calling upon the other party to amicably resolve the dispute by convening a joint meeting. Accordingly, the parties as per their convenience shall jointly convene the said meeting(s), wherein minutes of the said meeting(s) shall be prepared and countersigned by all the parties. It is mandatory to prepare minutes of meeting(s) and to be countersigned by all the parties, irrespective of the outcome of the said meeting(s).
- b. In the event the parties are unable to reach on any settlement in the said meeting(s), then the aggrieved party shall mandatorily resort to pre-litigation mediation mechanism with Delhi High Court Mediation Cell, New Delhi.
- c. It is only upon failure of the pre-litigation mediation mechanism with Delhi High Court Mediation Cell, then the aggrieved party shall resort to resolution of disputes through arbitration of a Sole Arbitrator. The appointing authority of Sole Arbitrator is CMD, WAPCOS Limited, to which neither of the parties have any objection nor they shall ever object.
- d. Subject to the parties agreeing otherwise, the Arbitration proceedings shall be conducted in accordance with the provisions of the Indian Arbitration and Conciliation Act, 1996 (amended as on date).
- e. It is also acknowledged and accepted that the Employer is only working as intermediary between the Contractor/Supplier and the Principal Employer/Owner, thus in the event, any dispute arises under the present agreement and referred to Arbitration for adjudication, then subject to corresponding clause in the Contract between Principal Employer/Owner & the Employer, Principal Employer/Owner shall also be made party to the said Arbitration proceedings. Also, the award including costs if any passed against the Employer and costs incurred in the proceedings shall be the sole responsibility of Principal Employer/Owner. The said clause if found inapplicable, even then the other terms of the Arbitration Clause shall survive and shall be acted upon.
- f. The place/seat of arbitration shall be Delhi and any award whether interim or final, shall be made, and shall be deemed for all purposes between the parties to be made, in Delhi. The arbitral procedure shall be conducted in English language and any award or awards shall be rendered in English. The procedural law of the arbitration shall be Indian Law. The award of the arbitrator shall be final and conclusive and binding upon the Parties.

- g. The Contract and any dispute or claim arising out of or in connection with it or its subject matter or formation (including non-contractual disputes or claims) shall be governed by and construed in accordance with the laws of India and the Parties submit to sole & exclusive jurisdiction of courts at Delhi.”

25.3 English Language

The request for arbitration, the answer to the request, the terms of reference, any written submissions, any orders and awards shall be in English and, if oral hearings take place, English shall be the language to be used in the hearings.

25.4 Performance during Arbitration

Pending the submission of and/or decision on a Dispute and until the arbitral award is published, the Parties shall continue to perform their respective obligations under the Contract without prejudice to a final adjustment in accordance with such award.

25.5 No arbitration for decision on sub-standard work

The decision of Engineer-in-Charge regarding the quantum or reduction as well as justification thereof in respect of payment for sub-standard work which may be decided to be accepted will be final and would not be open to arbitration.

CLAUSE 26 : CONTRACTOR INDEMNIFY EMPLOYER AGAINST PATENT RIGHTS

The contractor shall fully indemnify and keep indemnified the Employer against any action, claim or proceeding relating to infringement or use of any patent or design or any alleged patent or design rights and shall pay any royalties which may be payable in respect of any article or part thereof included in the contract. In the event of any claims made under or action brought against Employer in respect of any such matters as aforesaid, the contractor shall be immediately notified thereof and the contractor shall be at liberty, at his own expense, to settle any dispute or to conduct any litigation that may arise therefrom, provided that the contractor shall not be liable to indemnify the Employer if the infringement of the patent or design or any alleged patent or design right is the direct result of an order passed by the Engineer-in-Charge in this behalf.

CLAUSE 27 : LUMP SUM PROVISIONS IN TENDER – NOT APPLICABLE

CLAUSE 28 : ACTION WHERE NO SPECIFICATIONS ARE SPECIFIED

In the case of any class of work for which there is no such specifications as referred to in Clause 11, such work shall be carried out in accordance with the Bureau of Indian Standards Specifications. In case there are no such specifications in Bureau of Indian Standards, the work shall be carried out as per manufacturers' specifications, if not available then as per District Specifications. In case there are no such specifications as required above, the work shall be carried out in all respects in accordance with the instructions and requirements of the Engineer-in-Charge.

CLAUSE 29 : WITHHOLDING AND LIEN IN RESPECT OF SUM DUE FROM CONTRACTOR

- a) Whenever any claim or claims for payment of a sum of money arises out of or under the contract or against the contractor, the Engineer-in-Charge or the WAPCOS shall be entitled to withhold and also have a lien to retain such sum or sums in whole or in part from the security, if any deposited by the contractor and for the purpose aforesaid, the Engineer-in-Charge or the WAPCOS shall be

entitled to withhold the security deposit, if any, furnished as the case may be and also have a lien over the same pending finalisation or adjudication of any such claim. In the event of the security being insufficient to cover the claimed amount or amounts or if no security has been taken from the contractor, the Engineer-in-Charge or the WAPCOS shall be entitled to withhold and have a lien to retain to the extent of such claimed amount or amounts referred to above, from any sum or sums found payable or which may at any time thereafter become payable to the contractor under the same contract or any other contract with the Engineer-in-Charge of the WAPCOS or any contracting person through the Engineer-in-Charge pending finalization of adjudication of any such claim.

It is an agreed term of the contract that the sum of money or moneys so withheld or retained under the lien referred to above by the Engineer-in-Charge or WAPCOS will be kept withheld or retained as such by the Engineer-in-Charge or WAPCOS till the claim arising out of or under the contract is determined by the arbitrator (if the contract is governed by the arbitration clause) by the competent court, as the case may be and that the contractor will have no claim for interest or damages whatsoever on any account in respect of such withholding or retention under the lien referred to above and duly notified as such to the contractor. For the purpose of this clause, where the contractor is a partnership firm or a limited company, the Engineer-in-Charge or the WAPCOS shall be entitled to withhold and also have a lien to retain towards such claimed amount or amounts in whole or in part from any sum found payable to any partner/limited company as the case may be, whether in his individual capacity or otherwise.

- b) Employer shall have the right to cause an audit and technical examination of the works and the final bills of the contractor including all supporting vouchers, abstract, etc., to be made after payment of the final bill and if as a result of such audit and technical examination any sum is found to have been overpaid in respect of any work done by the contractor under the contract or any work claimed to have been done by him under the contract and found not to have been executed, the contractor shall be liable to refund the amount of over-payment and it shall be lawful for WAPCOS to recover the same from him in the manner prescribed in sub-clause (i) of this clause or in any other manner legally permissible; and if it is found that the contractor was paid less than what was due to him under the contract in respect of any work executed by him under it, the amount of such under payment shall be duly paid by WAPCOS to the contractor, without any interest thereon whatsoever.

Provided that the Government shall not be entitled to recover any sum overpaid, nor the contractor shall be entitled to payment of any sum paid short where such payment has been agreed upon between the WAPCOS on the one hand and the contractor on the other under any term of the contract permitting payment for work after assessment by WAPCOS.

CLAUSE 29A : LIEN IN RESPECT OF CLAIMS IN OTHER CONTRACTS

Any sum of money due and payable to the contractor (including the security deposit returnable to him) under the contract may be withheld or retained by way of lien by the Engineer-in-Charge or the Employer or any other contracting person or persons through Engineer-in-Charge against any claim of the Engineer-in-Charge or Employer or such other person or persons in respect of payment of a sum of money arising out of or under any other contract made by the contractor with the Engineer-in-Charge or the Employer or with such other person or persons.

It is an agreed term of the contract that the sum of money so withheld or retained under this clause by the Engineer-in-Charge or the Employer will be kept withheld or retained as such by the Engineer-in-Charge or the Employer or till his claim arising out of the same contract or any other contract is either mutually settled or determined by the arbitration clause or by the competent court, as the case may be and that the contractor shall have no claim for interest or damages whatsoever on this account or on any other ground in respect of any sum of money withheld or retained under this clause and duly notified as such to the contractor.

CLAUSE 30 : WATER FOR WORKS

The contractor(s) shall make his/their own arrangements for water required for the work and nothing extra will be paid for the same. This will be subject to the following conditions.

- (i) That the water used by the contractor(s) shall be fit for construction purposes to the satisfaction of the Project Manager, WAPCOS.
- (ii) The contractor(s) shall make his/their own arrangement of water connection and laying of pipelines from existing main of source of supply.
- (iii) The water charges @ 1 % on tendered value shall be recovered if water supplied by Government/ Principal Employer is used by contractor.

CLAUSE 30A : ALTERNATE WATER ARRANGEMENTS

The contractor shall be allowed to construct temporary wells in Government land for taking water for construction purposes only after he has got permission from the concerned Government Authority and inform the same to Engineer-In-Charge in writing. No charges shall be recovered from the contractor on this account, but the contractor shall be required to provide necessary safety arrangements to avoid any accidents or damage to adjacent buildings, roads and service lines. He shall be responsible for any accidents or damage caused due to construction and subsequent maintenance of the wells and shall restore the ground to its original condition after the wells are dismantled on completion of the work.

CLAUSE 31 : HIRE OF PLANT & MACHINERY

The contractor shall arrange at his own expense all tools, plant, machinery and equipment (hereinafter referred to as T&P) required for execution of the work.

CLAUSE 32 : EMPLOYMENT OF TECHNICAL STAFF AND EMPLOYEES

The contractor shall provide and employ skilled, semiskilled and unskilled labour as is necessary for proper and timely execution of the work with full quality control. The contractor shall provide all necessary superintendence during execution of the work and all along thereafter as may be necessary for proper fulfilling of the obligations under the contract.

The contractor shall immediately after receiving letter of acceptance of the tender and before commencement of the work, intimate in writing to the Engineer-in-Charge, the name(s), qualifications, experience, age, address(s) and other particulars along with certificates, of the principal technical representative to be in charge of the work and other technical representative(s) who will be supervising the work. Even if the contractor (or partner(s) in case of firm/ company) is himself / herself an Engineer, it is necessary on the part of the contractor to Employ principal technical representative / technical representative (s).

The contractor shall provide and employ on the site only such technical assistants as are skilled and experienced in their respective fields and such foremen and supervisory staff as are competent to give proper supervision to the work.

The Engineer-in-Charge shall be at liberty to object to and require the contractor to remove from the works any person who in his opinion misconducts himself, or is incompetent or negligent in the performance of his duties or whose employment is otherwise considered by the Engineer-in-Charge to be undesirable. Such person shall not be employed again at works site without the written permission of the Engineer-in-Charge and the persons so removed shall be replaced as soon as possible by competent substitutes.

CLAUSE 33 : LEVY/TAXES PAYABLE BY CONTRACTOR

- (i) The Contract price is inclusive of Goods and Service Tax (GST) and any other taxes, levies, royalties together with all general risks, liabilities and obligations set out or implied in the Contract, applicable Labour Cess, cost of insurance to this Contract, all applicable tax liabilities, Income Tax & Surcharges, etc. However, only the payment of GST shall be reimbursed by the Employer to the Contractor.
- (ii) The Contractor shall issue E-Invoice (if applicable for contractor firm)/Tax Invoices to Employer showing (a) Basic Amount (b) GST amount separately for each bill. The payment of GST amount shall be reimbursed to the Contractor only after uploading of GST amount by Contractor on GST portal to avail input benefit of GST by Employer.
- (iii) Notwithstanding anything contained above, the Contractor shall ensure payment of appropriate tax on the supplies made under the Contract. The Contractor shall comply with all applicable provision of Goods and Service Tax (GST) levied by Union Government and State Governments. The Contractor shall get himself registered and discharge his obligations for payment of taxes, filing of returns etc. under the appropriate provisions of law in respect of all the taxes, duties, levies, cess, etc. The Employer would have right to seek necessary evidence that the Contractor is registered under the law and duly discharging its obligations under the tax law, enabling the Employer to avail input tax credit.
- (iv) In case any law requires the Employer to pay tax on the Contract price on reverse charge basis, the amount of tax deposited by Employer would be considered as paid to the Contractor and, accordingly, the price payable to the Contractor would stand reduced to that extent.
- (v) In case the Contractor does not deposit the tax payable on execution of the Contract, or has not provided the tax invoice to Employer showing the amount of tax, or has not uploaded the document in computerized tax network as per prevailing law, leading to non-availability of inputs credit of the tax to Employer, the amount equivalent to such tax shall be deducted from the any amount payable to Contractor.
- (vi) The contractor shall deposit royalty and obtain necessary permit for supply of the red bajri, stone, kankar, etc. from local authorities.

If pursuant to or under any law, notification or order any royalty, cess or the like becomes payable by the Employer and does not any time become payable by the Contractor to the State Government, Local authorities in respect of any material used by the Contractor in the works, then in such a case, it shall be lawful to the Employer and it will have the right and be entitled to recover the amount paid in the circumstances as aforesaid from dues of the Contractor.

CLAUSE 34 : CONDITIONS FOR REIMBURSEMENT OF LEVY/TAXES IF LEVIED AFTER RECEIPT OF TENDERS

All tendered cost shall be inclusive of all taxes and levies (except GST) payable under respective statutes. However, if any further tax or levy or cess is imposed by Statute, after the last stipulated date for the receipt of tender including extensions if any and the contractor thereupon necessarily and properly pays such taxes/levies/cess, the contractor shall be reimbursed the amount so paid, provided such payments, if any, is not, in the opinion of the WAPCOS attributable to delay in execution of work within the control of the contractor.

Provided further that for Building and Other Construction Workers Welfare Cess or any tax (other than GST), levy or cess varied or imposed after the last date of receipt of tender including extension if any,

any increase shall be reimbursed to the contractor only if the contractor necessarily and properly pays such increased amount of taxes/levies/cess.

- (i) Provided further that such increase including GST shall not be made in the extended period of contract for which the contractor alone is responsible for delay as determined by WAPCOS for extension of time.
- (ii) The contractor shall keep necessary books of accounts and other documents for the purpose of this condition as may be necessary and shall allow inspection of the same by a duly authorized representative of the Government and/or the Engineer-in-Charge and shall also furnish such other information/document as the Engineer-in-Charge may require from time to time.
- (iii) The contractor shall, within a period of 30 days of the imposition of any such further tax or levy or cess, or variation or repeal of such tax or levy or cess give a written notice thereof to the Engineer-in-charge that the same is given pursuant to this condition, together with all necessary information relating thereto.

CLAUSE 35 : TERMINATION OF CONTRACT ON DEATH OF CONTRACTOR

Without prejudice to any of the rights or remedies under this contract, if the contractor dies, the Engineer-In-Charge on behalf of the WAPCOS shall have the option of terminating the contract without compensation to the contractor.

CLAUSE 36 : IF RELATIVE WORKING IN WAPCOS THEN THE CONTRACTOR NOT ALLOWED TO TENDER

The contractor shall not be permitted to tender for works in the WAPCOS responsible for award and execution of contracts in which his near relative is posted in WAPCOS. He shall also intimate the names of persons who are working with him in any capacity or are subsequently employed by him and who are near relatives to any Officer in the WAPCOS. Any breach of this condition by the contractor would render him liable to be debarred from tendering in WAPCOS any breach of this condition.

NOTE: By the term “near relatives” is meant wife, husband, parents and grand parents, children and grand children, brothers and sisters, uncles, aunts and cousins and their corresponding in-laws.

CLAUSE 37: NO GAZETTED ENGINEER TO WORK AS CONTRACTOR WITHIN ONE YEAR OF RETIREMENT

No engineer of gazetted rank or other gazetted officer employed in engineering or administrative duties in an engineering department of the Government of India shall work as a contractor or employee of a contractor for a period of one year after his retirement from government service without the previous permission of Government of India in writing. This contract is liable to be cancelled if either the contractor or any of his employees is found at any time to be such a person who had not obtained the permission of Government of India as aforesaid, before submission of the tender or engagement in the contractor's service, as the case may be.

CLAUSE 38 : THEORETICAL CONSUMPTION OF MATERIAL- NOT APPLICABLE

CLAUSE 39 : COMPENSATION DURING WARLIKE SITUATION

The work (whether fully constructed or not) and all materials, machines, tools and plants, scaffolding, temporary buildings and other things connected therewith shall be at the risk of the Contractor until the work has been delivered to the Engineer-in-Charge and a certificate from him to that effect obtained. In the event of the work or any materials properly brought to the site for incorporation in the work being damaged or destroyed in consequence of hostilities or warlike operation, the Contractor shall when ordered (in writing) by the Engineer-in-Charge to remove any debris from the site, collect and properly

stack or remove in store all serviceable materials salvaged from the damaged work and shall be paid at the Contract rates in accordance with the provision of this agreement for the work of clearing the site of debris, stacking or removal of serviceable material and for reconstruction of all works ordered by the Engineer-in-Charge, such payments being in addition to compensation upto the value of the work originally executed before being damaged or destroyed and not paid for. In case of works damaged or destroyed but not already measured and paid for, the compensation shall be assessed the Engineer-in-Charge upto Rs. 2,00,000/- and by the next higher officer concerned for a higher amount. The Contractor shall be paid for the damages/destruction suffered and for restoring the material at the rate based on analysis of rates tendered for in accordance with the provision of the Contract. The certificate of the Engineer-in-Charge regarding the quality and quantity of materials and the purpose for which they were collected shall be final and binding on all parties to this Contract.

Provided always that no compensation shall be payable for any loss in consequence of hostilities or warlike operations (a) unless the Contractor had taken all such precautions against air raid as are deemed necessary by the A.R.P. (Air Raid precaution) Officers or the Engineer-in-Charge (b) for any material etc. not on the site of the work or for any tools, plant, machinery, scaffolding, temporary building and other things not intended for the work.

In the event of the Contractor having to carry out reconstruction as aforesaid, he shall be allowed such extension of time for its completion as is considered reasonable by the Engineer-in-Charge.

CLAUSE 40 : APPRENTICES ACT PROVISIONS TO BE COMPLIED WITH

The contractor shall comply with the provisions of the Apprentices Act, 1961 and the rules and orders issued thereunder from time to time. If he fails to do so, his failure will be a breach of the contract and the WAPCOS may, in his discretion, cancel the contract. The contractor shall also be liable for any pecuniary liability arising on account of any violation by him of the provisions of the said Act.

CLAUSE 41 : RELEASE OF SECURITY DEPOSIT AFTER LABOUR CLEARANCE

Release of Security Deposit of the work shall not be refunded if any complaint from labour / labour department against the contractor deployed at site for execution of works. As soon as the work is virtually complete the contractor shall apply for the clearance certificate to the Labour Officer under intimation to the Engineer-in-Charge.

CLAUSE42: INSURANCE

1. Requirements

Before commencing execution of works, it shall be obligatory for the contractor to obtain at his own cost stipulated insurance cover under the following requirements:

- a) Contractor's all risk and Third Party Cover.
- b) Liability under the workmen's compensation Act, 1923, Minimum Wages Act, 1948 and Contract Labour (Regulation and Abolition) Act, 1970.
- c) Accidents to staff, Engineers, Supervisors and others who are not governed by workmen's compensation Act.
- d) Damage to material, machinery and works due to fire theft etc.
- e) Any other risk to be covered by insurance as specified by the employer.

2. Policy in Joint Names of Contractor and Employer

The policy referred above shall be obtained in the joint names of the contractor and the employer and shall inter-alia provide coverage against the following, arising out of or in connection with execution of works, their maintenance and performance of the contract.

- a) Loss of life or injury involving public, employee of the contractor, or that of employer and Engineer, labour etc.
- b) Injury, loss or damage to the works or property belonging to public, government bodies, local authorities, utility organizations, contractors, employer or others.

3. Third Party Insurance

Contractor is required to take third party insurance cover for an amount of 5% (five percent) of contract value from Nationalized insurance company for insurance against any damage, injury or loss which may occur to any person or property including that of Employer / Owner, arising out of the execution of the Works or Temporary works. Wherever required by Employer the Contractor shall produce the policy or the policies of Insurance and the receipt of payment of the current premiums.

Above policies shall remain in force throughout the period of execution of the works.

CLAUSE 43 : PREFERENCE TO MAKE IN INDIA

The provisions of revised 'Public Procurement (Preference to Make in India) Order 2017-Revision' issued by Department of Industrial Policy and Promotion under Ministry of Commerce and Industry vide letter no.-P45021/2/2017-PP (BE-II) as amended on 16.09.2020 shall be applicable to the bidding process and award of the contract shall be done accordingly.

Verification of Local Content

- i. The bidder at the time of tender, bidding or solicitation shall be required to indicate percentage of local content and provide self-certification that the item offered meets the local content requirement of the tender. They shall also give details of the location(s) at which the local value addition is made.
- ii. In cases of procurement for a value in excess of Rs 10 Crores, the bidder shall be required to provide a certificate from the statutory auditor or cost auditor of the company (in the case of companies) or from a practicing cost accountant or practicing chartered accountant (in respect of suppliers other than companies) giving the percentage of local content.

CLAUSE- 44: RULE 144 (XI) IN GENERAL FINANCIAL RULES (GFRS) 2017

- i. Any bidder from a country which shares a land border with India will be eligible to bid in this tender only if the bidder is registered with the Competent Authority.
- ii. Bidder from a country which shares a land border with India" for the purpose of this Order means:-
 - a) An entity incorporated, established or registered in such a country; or
 - b) A subsidiary of an entity incorporated, established or registered in such a country; or
 - c) An entity substantially controlled through entities incorporated, established or registered in such a country; or
 - d) An entity whose beneficial owner is situated in such a country; or
 - e) An Indian (or other) agent of such an entity; or
 - f) A natural person who is a citizen of such a country; or
 - g) A consortium or joint venture where any member of the consortium or joint venture falls under any of the above
- iii. The beneficial owner for the purpose of clause above will be as under:
 - 1. In case of a company or Limited Liability Partnership, the beneficial owner is the natural person(s), who, whether acting alone or together, or through one or more juridical person, has a controlling ownership interest or who exercise control through other means.

2. “Controlling ownership interest” means ownership of or entitlement to more than twenty- five per cent. Of shares or capital or profits of the company;
 3. “Control” shall include the right to appoint majority of the directors or to control the management or policy decisions including by virtue of their shareholding or management rights or shareholders agreements or voting agreements;
 4. In case of a partnership firm, the beneficial owner is the natural person(s) who, whether acting alone or together, or through one or more juridical person, has ownership of entitlement to more than fifteen percent of capital or profits of the partnership;
 5. In case of an unincorporated association or body of individuals, the beneficial owner is the natural person(s), who, whether acting alone of together, or through one or more juridical person, has ownership of or entitlement to more than fifteen percent of the property or capital or profit of such association or body of individuals;
 6. Where no natural person is identified under (1) or (2) or (3) above, the beneficial owner is the relevant natural person who holds the position of senior managing official;
 7. In case of a trust, the identification of beneficial owner(s) shall include identification of the author of the trust, the trustee, the beneficiaries with fifteen percent or more interest in the trust and any other natural person exercising ultimate effective control over the trust through a chain of control or ownership.
- iv. An Agent is a person employed to do any act for another, or to represent another in dealings with third person. The successful bidder shall not be allowed to sub-contract works to any contractor from a country which shares a land border with India unless such contractor is registered with the Competent Authority.

SECTION- V

SPECIAL CONDITIONS OF CONTRACT

SECTION-V

SPECIAL CONDITIONS OF CONTRACT

1.0 SPECIAL CONDITIONS OF CONTRACT

The Special Condition of Contract (SCC) shall be followed by the Contractor in addition to the General Condition of Contract (GCC) of tender document. The following General Condition of Contract of this tender are modified/added as detailed below. In case of any discrepancy between GCC and SCC, the SCC will succeed over GCC.

| GENERAL RULES AND DIRECTIONS under GCC | | |
|---|--|---|
| DEFINITIONS | | |
| 2 (ix) | Market Rate Percentage on cost of materials and labour to cover all overheads and profits | 15% |
| 2(x) | Schedule(s) | Delhi Schedule Rates- 2019 (CPWD DAR-2019) for Civil & Fire Fighting works; DSR-2018 for E&M and Horticulture & Landscaping works |

| GCC Clause No. | Particular | Modified/ Added |
|-----------------------|----------------------|--|
| Clause 1 | Performance Security | <p>a) Within 21 (Twenty one) days of receipt of the Letter of Award, but not later than the date of the signing of the Agreement, the successful Bidder shall deliver to the Employer a Performance Security in any of the forms given below for an amount equivalent to 5% of the Tended Value:</p> <ul style="list-style-type: none">• a Bank Guarantee issued by a Scheduled Commercial Bank approved by Reserve Bank of India (RBI) as per Annexure-I of Bid document; or• a deposit receipt of a Scheduled Commercial Bank approved by Reserve Bank of India (RBI) in favour of WAPCOS Limited payable at Delhi/ Gurgaon. <p>b) The Bidder quoting below Minus (-) 5% of the estimated cost put to tender shall submit the additional performance guarantee of amount equal to the percentage of quoted amount by which the bidder has quoted below -5% of the estimated cost. For example: if the bidder quotes -5% of the estimated cost, then no additional performance guarantee is required. If the bidder quotes -6% of the estimated cost, then the bidder has to submit additional performance guarantee equal to 1% of the quoted amount. Similarly, if the bidder quotes -7% of the estimated cost, then the bidder has to submit additional performance guarantee equal to 2% of the quoted amount and so on. The validity of the Additional Performance Guarantee shall be same as the original</p> |

| GCC Clause No. | Particular | Modified/ Added |
|-----------------|--|---|
| | | <p>performance guarantee. The Additional Performance Guarantee may be submitted in the same format of Performance Guarantee or this additional amount may be added to the Performance Guarantee.</p> <p>c) The confirmation of the Bank Guarantee shall be sought from the issuing bank through Structured Financial Messaging System (SFMS), from our banker Indian Overseas Bank, NHB, Gurugram, Branch Code: 1935, IFSC code: IOBA0001935 and Beneficiary as WAPCOS Limited. This shall also be applicable in respect of confirmation of any extension of the Bank Guarantee as and when required.</p> |
| Clause 10 B(iv) | Recovery of Mobilization advance | <p>Applicable</p> <p>The mobilization advance shall be recovered @25% of the value of work done (excluding GST) from each running account bill till complete mobilization advance is recovered.</p> |
| Clause 12 | Deviations / Variations Extent and Pricing | |
| | Clause 12.1 | Not applicable |
| | Clause 12.2(a) | <p>Modified as:</p> <ul style="list-style-type: none"> • “In the case of extra item(s) (items that are completely new and not in the scope of works as per tender condition and non-scheduled item within Delhi Schedule Rates-2019 (CPWD DAR-2019) for Civil & Fire Fighting works; DSR-2018 for E&M and Horticulture & Landscaping works, the contractor shall submit proper analysis on the basis of the market rates as per the direction of Engineer-in –charge and shall be paid in accordance with rate approved by WAPCOS plus applicable Goods and Service Tax (GST). • In case the extra item being the Scheduled Item [Delhi Schedule Rates- 2019 (CPWD DAR-2019) for Civil & Fire Fighting works; DSR-2018 for E&M and Horticulture & Landscaping works], then rate of item shall be achieved by 89.29% (100/1.12 because 12% GST is already included in DSR) of schedule rate + 5.00% cost index + increased / decreased in the rate as per the % quoted above or below by Contractor. The applicable GST will be paid over the achieved rate after approval of WAPCOS.. |
| | Clause 12.2(b) | <p>Modified as:</p> <ul style="list-style-type: none"> • In this case of substituted item(s) being DSR item [Delhi Schedule Rates- 2019 (CPWD DAR-2019) for Civil & Fire Fighting works; DSR-2018 for E&M and Horticulture & Landscaping works]), then rate of substituted item shall be achieved by 89.29% (100/1.12 |

| GCC Clause No. | Particular | Modified/ Added |
|----------------|---|---|
| | | <p>because 12% GST is already included in DSR) of schedule rate + 5.00% cost index + increased / decreased in the rate as per the % quoted above or below by Contractor. The applicable GST will be paid over the achieved rate after approval of WAPCOS.</p> <ul style="list-style-type: none"> In this case of substituted item(s) being Non DSR item [Delhi Schedule Rates- 2019 (CPWD DAR-2019) for Civil & Fire Fighting works; DSR-2018 for E&M and Horticulture & Landscaping works], the contractor shall submit proper analysis on the basis of the market rates after direction engineer-in-charge / WAPCOS. |
| | <p>Clause 12.2(c) Deviation Limit for all items of work</p> | <p style="text-align: center;">100%</p> <ul style="list-style-type: none"> Modified as “In the case of deviated item(s) beyond the % mentioned above [non-scheduled item within Delhi Schedule Rates- 2019 (CPWD DAR-2019) for Civil & Fire Fighting works; DSR-2018 for E&M and Horticulture & Landscaping works],. The contractor may within fifteen days of receipt of order or occurrence of the item(s) claim rates, supported by proper analysis on the basis of the market rates. Contractor shall be paid in accordance with rate approved by WAPCOS plus applicable Goods and Service Tax (GST) on work contract. In this case of Deviated item being DSR item [Delhi Schedule Rates- 2019 (CPWD DAR-2019) for Civil & Fire Fighting works; DSR-2018 for E&M and Horticulture & Landscaping works]), then rate of deviated item shall be achieved by 89.29% (100/1.12 because 12% GST is already included in DSR) of schedule rate + 5.00% cost index + increased / decreased in the rate as per the % quoted above or below by Contractor. The applicable GST will be paid over the achieved rate after approval of WAPCOS. |
| | <p>Additional Clause-1 Minimum Amount of Running Account Bill</p> | <p>The Contractor shall periodically submit Running Account (RA) bills for the gross work done not be less than Rs 1.50 Crore for Construction. All running bills shall be accompanied with the Geo-tagged (GPS) clear photographs in sufficient number and angles illustrating the progress of work and for which claims raised in RA bill. The photographs shall be duly signed by the Contractor. The contractor shall submit the bill in the standard format agreed by the NESTS/ WAPCOS</p> |

| GCC Clause No. | Particular | Modified/ Added |
|----------------|--|---|
| | Additional Clause-2 Reimbursement of ESI / EPF | The WAPCOS shall reimburse ESI/EPF to the contractor based on the actual submission of proof of payment to the beneficiary account to them. The maximum amount of reimbursement to the contractor on account of ESI / EPF shall be 4% of Awarded cost |

2.0 ADDITIONAL CONDITIONS OF CONTRACT

2.1 Monthly Bill of Electric & water Department for the EMRS Campus

The contractor shall pay monthly billing charges of electric connection and water connection (taken by contractor on behalf of NESTS, to run the EMR School project) up to the successful handing over of the project to NESTS, from the date of installation of connections. These charges will be borne by the contractor. Hence contractor shall quote the cost in tender accordingly.

2.2 Third Party Inspection of Works

Notwithstanding the any other conditions of Contract, the Employer shall get the work inspected by any third party (IIT/ NIT as appointed by WAPCOS/NESTS) during the progress of work or any time after the construction and development of project up to the defect liability period. The Contractor, his consultant, subcontractors of all tiers and suppliers thereof shall make available during the inspection with all records necessary to demonstrate that the Works have been executed in accordance with the Contract Agreement.

The Contractor shall also be responsible for consequential effects arising out during the inspection done by the third party from time to time and will take appropriate action for rectification of defective work. Rectification of defective works or replacement of sub-standard materials or articles, as pointed out by the third party authorized by Employer, will be carried out or replaced by the Contractor at his own risk and cost. The Employer will not pay any extra amount for such rectification or replacement

2.3 The Contractor shall submit the Standard Operating Procedure (SOP) / Quality Control & Quality Assurance Plan as finalized by the NESTS and submit to the WAPCOS & Third Party Quality Assurance Agency (TPQAA) for checking & verification during visit of TPQAA. The reports of TPQAA will be the part of the Running Account Bills which will be raised after completion of important milestones / critical activities as defined by NESTS.

2.4 Inspection of the work by any Government Agency

The Contractor shall be responsible for consequential effects arising out during the inspection done by the Chief Technical Examiner Cell, Central Vigilance Commission or Committee constituted by the Principal Employer or construction site visiting team of Principal Employer or by the Building Works Committee or third party authorized by WAPCOS or any Statuary Committee or by any duly authorized representative of WAPCOS, during the progress or any time after the construction and development of project up to the defect liability period, and will take appropriate action for rectification of defective work and modifications as suggested by the above teams/ group/ individual. Rectification of defective works or replacement of sub-standard materials or articles or modifications, as pointed out by the Chief Technical Cell, Central Vigilance Commission, committee constituted by Principal Employer, construction site visiting team of Principal Employer, Building Works Committee or authorized representative of WAPCOS or third party authorized by Employer/ Principal Employer or any Statuary Committee, will be carried out or replaced/ modified by the Contractor at his own risk and cost.

2.5 Prior Approval from Fire Department & Electrical Department

Contractor shall take prior approval well in advance of electrical substation, layout, drawings, electrical equipment, solar installation drawings/documents etc. from concern Electrical Department/ local Authorities before order of procurement & commencing the Electric work. Contractor shall take prior NOC from Local Fire Department & submit the project drawings to the Fire Department before commencing the construction works for checking and verification of fire department as per the fire norms of that particular region. After the completion of work, Contractor shall apply and provide final fire department NOC.

2.6 Approach Roads and Transportation of Equipment & Materials

Contractor will be permitted to use the existing roads in the establishment area for the purpose of transporting equipment and materials and for use of labour etc if Principal Employer permits the same. The Engineer-in-Charge, however, will not undertake to provide any approach roads to the actual site of work. It shall be the entire responsibility of the Contractor to provide and maintain such temporary approach roads including cross drainage works if any at his own cost for the purpose of movement of men, materials and equipment.

2.7 Supply of Water for Construction Purpose

Contractor shall make his own arrangement of water required for the work, at his own cost, subject to the approval of the Engineer-in-Charge. However, the Contractor will be permitted to drill bore well/s at site and the Contractor shall pay all charges to local bodies / authorities / royalty if any and obtain statutory approvals, geological survey provide pump, pipeline, casing with all accessories required for functioning of the bore well. The water should be tested in an approved laboratory and should be permitted to use in work if found suitable for construction. However, Contractor shall make alternate arrangements in case the water is not found fit for construction. After completion of work the Contractor will handover complete bore well/s with pump/s and accessories to the Employer at no cost. The water storage tanks should be leak proof and wastage and misuse of water is strictly prohibited, Contamination and pollution of water to be strictly avoided. Construction water should not be used for drinking or for domestic purpose.

2.8 Monthly Bill of Electric & Water Department

The Contractor shall make his own arrangement for the Temporary connection for Supply of Electricity & Water for Construction Purpose as required at his own cost and pay their monthly bill. After getting permanent connection during final stage of construction for Principal Employer/ Project, contractor shall pay monthly billing charges of Permanent electric and water connection (taken by contractor on behalf of Principal Employer, to run project) up to the successful handing over of the project to Principal Employer, from the date of installation of connections. These charges will be borne by the contractor. Hence contractor shall quote the cost in tender accordingly

2.9 Handing Over of the Project

Contractor shall apply/ liaison, well before the completion of project, for permanent electricity connection, Electric load enhancement, solar net metering from concerned Electrical Departments for Permanent supply of electricity to the project within the completion period of the project. After completion of installation of electric equipments & connections, Contractor shall arrange necessary testing of equipment, panels, transformer, DG set, solar installation etc. at site as per norms and provide test reports to Employer/local Authorities. After that Contractor will arrange all necessary approval/NOC from Chief Electrical Inspector Department/ local Authorities etc. to submit further to the electricity department for getting permanent electrical

supply to the project.

Contractor shall apply/ liaison, well before the completion of project, permanent water connection & Sewerage Connection, gas connection, etc. from concerned Departments/ Government Authorities which are mandatory to make the project operational and get the connection within the completion period of the project.

Contractor shall provide necessary Statutory Approvals/NOCs/ License from all local Government/ Statuary Authorities including Fire, Forest, Electrical, Pollution, Environment, Lift, DG Set, final Occupancy Certificate required before handing over the project to the Principal Employer.

Contractor will hand over the project to Employer/Principal Employer after successful completion of each component of the project along with submission of all the required documents i.e. As- built drawings, Inventory list, guarantee / warranty bonds, certificates & invoices of equipment, lock and key of each room, NoCs form various Departments and final Occupancy Certificate from Local Body with complete satisfaction and acceptance by Principal Employer within the completion period of the project.

The statutory fees, if any will be deposited by the contractor for the above will be reimbursable to the contractor by Employer after providing the original receipt of the concern department. No other amount will be paid to the contractor for above works.

The partial handing over of works components shall not be considered. The Warranty/Defect Liability Period shall commence from the date of issue of the Taking Over Certificate by Principal Employer or issue of Completion Certificate by Principal Employer or agreed date of start of Defect Liability Period by the Principal Employer whichever is later along with submission of all the required documents i.e. As- built drawings, Inventory list, guarantee / warranty bonds, certificates & invoices of equipment, lock and key of each room and NoCs form various Departments

2.10 Ceremony/Inaugural Function

The contractor shall make all arrangements for Foundation Stone/ Ground Breaking Ceremony/Inaugural Function etc. for the project as required and the cost towards it deemed to be included in quoted cost by the contractor. Any expenditure already incurred/to be incurred by Employer on account of ground breaking ceremony/inaugural function etc, shall be recovered from the Contractor.

2.11 Setting out Base Lines and Levels

The Contractor shall establish at site the layout of each component of the work from base lines and grids established by the Employer and shall be responsible for all measurements in connection therewith. The Contractor shall, at his own expenses, furnish all stakes, templates, platform, equipment, ranges and labour that may be required in setting out or laying out any part of the work. The Contractor shall be held responsible for the proper execution of the work to such lines, levels and grids as may be established or indicated on the drawings and specifications. The Contractor shall check the bench marks and stakes existing at the site for laying out lines and levels.

The Contractor has to construct and maintain proper bench marks at all salient locations/positions in order that the lines and levels may be accurately checked at all times. Theodolite/ Total Station, Levels, Prismatic Compass, Chain, Steel and FRP Tapes and all other surveying instruments found necessary on the works shall be provided by the Contractor for use at site in connection with this work.

2.12 Co-operation & Co-ordination with other Agencies:

The Contractor shall have to make Coordination with other agencies engaged at the site by the

Employer at no extra cost and share the Site with other Contractors/agencies, public authorities, utilities working in the area, if any. The Contractor will carry out the entire work in a planned manner by coordinating his work with other agencies, who will be simultaneously carrying out work in the same area and also co-ordinate in connection with the position of various fixtures, inserts, embedment's and other allied work connected with the completion of the building / subject work.

In case of any dispute between the agencies engaged on the same work, decision of Engineer-in-Charge shall be final and binding.

2.13 Operations and Storage Areas

All operations of the Contractor shall be confined to areas authorized by the Project Manager, WAPCOS and storage of materials shall be over the areas specially indicated by the Project Manager, WAPCOS. Materials like sand and metal of different sizes shall be stored in properly constructed bins with hard floor to avoid inter mixing as well as mixing with objectionable materials. The Contractor shall be obliged to keep the premises in hygienic conditions by proper drainages of the area provided with suitable approaches throughout the period of Contract. He shall rectify all damages caused to the Government property within the areas thus allotted. He shall be responsible to clear all rank, vegetation at site at his own cost.

2.14 Contractor's Storage and Site Office

The Contractor shall make own arrangement for storing his equipment, plant, materials etc. and for his site office and cement godown. The Contractor be solely responsible for watching or guarding his property and materials. Contractor shall cover all materials at site with requisite insurance against theft, larceny, dacoits, fire tempest and flood. The Contractor, however, shall have to dismantle the shed and vacate the land after the receipt of due notice from the Project Manager, WAPCOS if the same is obstructing any work. The Contractor should obtain necessary permission / approval from Statutory Authorities such as Municipal corporations / Local bodies etc. for construction of temporary structures at site of work such as cement godown, stores, site office etc. It will be responsibility of the Contractor to prepare proper plans, to pay any requisite fees to statutory authorities and to execute the work for the temporary structure at their own cost as per the conditions and rules laid by statutory authorities.

The Engineer-in-Charge or his authorized representative shall have a right at any time to inspect and examine any stores and materials intended to be used in or on the works either on the site or at any factory or workshops or other places where such stores or materials are being constructed or manufactured or processed or any place from where they are being obtained and the Contractor shall give such facilities as required to be given for such inspection and examination.

The Engineer-in-Charge or his authorized representative shall be entitled to have tests made without any extra cost to the Employer at the laboratory selected by the Employer for any stores and or materials supplied by the Contractors, who shall provide at his own expense all the facilities which the Engineer-in-Charge may require for this purpose.

Any stores and materials brought to site for use on the work and which has been rejected by Engineer-in-Charge shall be immediately removed off the site by Contractor at his own expenses and intimate in writing accordingly to the Engineer-in-Charge. The rejected materials shall not be used in any manner in the construction of the project.

2.15 Temporary Buildings

Any temporarily buildings and office facilities as required by the Contractor shall be arranged by the Contractor at his own expense. Area for the same will be made available by the Employer, if available. After the work is over, all these temporary facilities shall be removed by the Contractor at his own expense within 10 days from the date of completion.

Labour Camp is permitted at site after approval of Principal Employer. However, no labour shall be permitted to stay in the partly completed building at any time. Unauthorized occupation of

any area/partly completed building by the Contractor's labourer will be treated as trespass and action will be taken to evict them including termination of Contract if deemed fit. Sanitary as well as water supply and drainage facilities as required by the labour laws in force, are to be provided by the Contractors at his own cost. The labour camp should be dismantled by the Contractor before handing over the buildings.

2.16 Traffic Interference & Inconvenience to the Public

The Contractor shall so conduct his operations as to interfere as little as possible with the traffic/public. When interference to traffic is inevitable, a notice of such interference shall be given to the Project Manager, WAPCOS well in advance (at least 2 days) at any stage, if it becomes necessary to divert the traffic, the Contractor shall obtain permission from the local traffic authorities at his own expense. The Employer will render reasonable assistance in the matter. The Contractor shall take all precautionary and other measure, such as providing warning signals, temporary diversion etc. all as directed by the Project Manager, WAPCOS.

The Contractor shall not deposit materials anywhere at work site which will seriously inconvenience the public. The Project Manager, WAPCOS may require the Contractor to remove any materials which are considered to be a danger or inconvenience to the public or cause them to be removed at the Contractor's cost.

The Contractor shall exercise full care to ensure that no damage is caused by him or his workmen, during the operation to the existing water supply and power lines. The cost of any such damage and risks arising out of this shall be entirely borne by the Contractor.

2.17 Drainage around the Buildings and Foundation for other Works

The Contractor shall be entirely responsible for the provision and maintenance of efficient drainage arrangements in the work site to lead all water whatsoever pumped out from the excavations on account of rains, floods, springs or any other source whatsoever. The foundation trenches shall be kept free from water while all the works below ground level are in progress.

Flooding or ponding of water in the work site shall not be permitted under any circumstances whatsoever and the Contractor shall take all necessary precautions to prevent the same by providing suitable pumps and other dewatering arrangement.

The cost of repairing damages if any, to the work under execution or to any government property in and around the site shall be entirely borne by the Contractor where such damages are due to his non-compliance with the above conditions.

2.18 Maintenance of Entire Electrical Installation

As mentioned above, the Contractor shall maintain his entire electrical installation, appliances etc. in good and safe condition as required under relevant rules and BIS codes of practice etc. till completion of works at his own cost. However, the following precautions and directives shall be followed in addition to observing other essential rules:

- a. The minimum clearance (measured at the lowest sag point) to be maintained for all overhead lines shall be 4 Mtrs. cross country or along roads and 6.1 metres across roads.
- b. Metallic poles as a general rule should be avoided and if used should be earthed individually.
- c. All loose hanging of wires and cables should be avoided. The line wires should be properly supported and an approved method of fixing shall be adopted.
- d. Installation shall not cause any hindrance to the normal movement of men and materials at site.
- e. All cables and wires should be adequately protected against mechanical damage during construction activity of all Contractors, working at site.
- f. In case the cable is required to be laid in ground, it should be adequately protected by covering the same with bricks, R.C.C. tiles or any other approved means and cable markers provided at suitable intervals as per approval of the Engineer-in-Charge.
- g. Laying of cable and wires direct on floor shall not be allowed but if absolutely

necessary for some very short lengths, the same shall be taken through suitable mechanical covering like G.I. / M.S. Pipes etc.

- h. All the cut door switch boards, equipment etc., should be adequately protected against rain or preferably they should not be exposed to weather.
- i. If overhead lines using bare conductors are installed, a guard wire system of adequate size shall run along the cables / wires and earthed effectively.
- j. The connection for portable machines shall be taken only through suitably rated 3 pin socket points. Iron clad industrial type outlets are preferred. While taking supply through socket outlet a plug top must be used, avoiding inserting of loose wires in the sockets. The third pin of the plug shall invariably be earthed and 3 core wire of appropriate specifications and capacity shall be used.
- k. All three- phase equipment shall be provided with duplicate earthing. All metallic frames, light fixtures, portable equipment's etc. should be effectively earthed to main earthing.
- l. Duly authorized persons having valid wireman's license / competence certificate must be employed under the supervision of a qualified and experienced Electrical Supervisor for carrying out electrical work and repair of electrical equipment, installation and maintenance etc. at site.
- m. Special precaution shall be taken by the Contractor not to disturb the sapling/trees recently planted by the side of the compound wall. The sapling/trees fall within the building/road etc. shall be transplanted to suitable place with written approval of the Engineer-in-Charge and maintained by the Contractor till completion of works at his own cost.

2.19 Proper drawings and instructions

The Contractor shall provide shop drawings and other drawings to the Engineer-in-Charge in line with the requirement of contract agreement from time to time for approval for the purpose of proper and adequate execution and maintenance of the work and the Contractor shall carry out the work and be bound by the same.

Copies of the drawings approved by the Engineer-in-Charge and the construction drawings issued shall be kept by the Contractor at the site and the same shall at all reasonable times be made available for inspection and use by the Engineer-in-Charge and any other person authorized by the Engineer-in-Charge.

2.20 Employment of Staff for Plumbing & Electrical Works

- Employment of certified plumber: Certified plumbers should be employed by the Contractor on the work for main sewer, filtered and unfiltered main.
- Employment of licensed electrical foreman: The Contractor should employ a licensed electrical foreman to supervise the Electrical works.

2.21 Urgent repairs

If by reason of any accident or failure or other event occurring to or in connection with the work or any part thereof either during the period of construction or maintenance, any remedial or other work or repair shall in the opinion of the Project Manager, WAPCOS be urgently necessary for security etc. and the Contractor is unable or unwilling, at once, to do such work or repair, the Project Manager, WAPCOS may be his own or other workmen do such work or repair as he may consider necessary. If the work or repair so done which in the opinion of the Project Manager, WAPCOS, the Contractor was liable to do at his own expenses under the Contract and all cost and charges properly incurred by the Project Manager, WAPCOS in so doing shall on demand be paid by the Contractor or may be deducted from any sum due or which may become due to the Contractor provided always that the Project Manager, WAPCOS shall soon after the occurrence of any such emergency as may be reasonable, practicable, notify the Contractor thereof in writing.

2.22 Security Regulations

The Contractor has to strictly follow the security regulations at the work site regarding entry of personnel, material etc. and any other regulation that might be enforced from time to time. All materials and articles brought by the Contractor to the work site shall have to be declared at the security gate. Similarly, no materials shall be taken out from the premises without proper gate pass.

The Contractors, Suppliers, vendors, workers engaged in work/business will be issued with renewable entry permit to avoid unauthorized entry in the work site on scrutiny of applications in prescribed form.

For working on Sundays, Holidays and late hours, even though permission will be accorded by the Engineer-in-Charge, the Contractor will have to make application to the Engineer-in-Charge also and keep them informed well in advance.

The area where the proposed work is to be carried is residential / non-residential area under the control of Security authorities, entry to the site of work shall be through the main gate only. The Contractor shall follow strictly the security regulations at site of work regarding entry of personnel, materials etc. and other regulations that might be enforced from time to time at the work site and also in the campus for smooth and efficient operation. The Contractors, his agents, representatives, workmen etc. and his materials, carts, trucks or other means of transport etc. will be allowed to enter through and leave from such point of entry/exit at such times, the authorities in charge of the area, at their sole discretion, may permit.

The Contractors, his agents and representatives are required to be in possession of the individual identity / muster cards or passes. The muster cards or passes are examined by the security staff at the time entry / exit inside the premises and also at any time or number of times within such area.

The Contractor will have to apply for entry/muster permits of likely number of labour to be engaged during the week for the workers and authorize their representatives to collect the entry permits for labour from the Employer's Security Authorities.

It will be the responsibility of the Contractor to maintain the list of laborers permitted to work inside the premises in a register and the representative of Contractor's labour will have to issue entry pass to each labour after making necessary entry in the registers.

The Contractor, his agents, representatives, workmen shall strictly observe the orders pertaining to prevailing fire precautions.

In addition to the above, other security regulations as may be imposed by the Security authorities / Project Manager, WAPCOS shall be complied with / observed by the Contractor and his workmen, in addition to the above.

Any breach of above security regulations and rules in force from time to time will be viewed seriously. No claim whatsoever will be entertained by the Employer on account of the observation of the Security regulations.

2.23 Watch and Ward and Lighting

The Contractor shall in connection with the works provide and maintain at his own cost all lights, guards, fencing and watching when and where necessary or as required by the Project Manager, WAPCOS and duly constituted authority for the protection of the workers or for safety and convenience of the public or others. The Contractor shall be responsible for all damages and accidents caused due to negligence in this regard.

It will be the entire responsibility of the Contractor to protect the work(s) carried out by them including the fittings, fixtures and other accessories provided by them till the entire work is satisfactorily handed over to the Employer.

2.24 Removal of rejected/sub-standard materials.

The following procedure shall be followed for the removal of rejected/sub-standard materials from the site of work:

- (i) Whenever any material brought by the contractor to the site of work is rejected, entry thereof should invariably be made in the Site Order Book under the signature of the Project Manager, WAPCOS, giving the approximate quantity of such materials.
- (ii) As soon as the material is removed, a certificate to that effect shall be recorded by the Project Manager, WAPCOS against the original entry, giving, the date of removal and mode of removal, i.e., whether by truck, carts, or by manual labour. If the removal is by truck, the registration number of the truck should be recorded.
- (iii) When it is not possible for the Project Manager, WAPCOS to be present at the site of work at the time of actual removal of the rejected/sub-standard materials from the site, the required certificate should be recorded by the Authorized Representative of WAPCOS, and the Project Manager, WAPCOS should countersign the certificate recorded by the Authorized Representative.

2.25 Special Conditions for Steel:

The contractor shall procure TMT bars of Fe500/Fe500D/Fe550/Fe550D grade (the grade to be procured is to be specified) from primary steel producers as per the list of approved makes or any other producer as approved by WAPCOS who are using iron ore as the basic raw material / input and having crude steel capacity of 2.0 Million tonnes per annum and above

2.26 Special conditions for Cement

The contractor shall procure 43 grade Ordinary Portland Cement (conforming to IS : 8112), Portland pozzolona cement (confirming to IS : 1489 : Part –I) as required in the work, from reputed manufacturers of cement as per the list of approved makes or from any other reputed cement manufacturer, having a production capacity not less than one million tones per annum as approved by WAPCOS. The tenderers may also submit a list of names of cement manufacturers which they propose to use in the work. The tender accepting authority reserves right to accept or reject name(s) of cement manufacture(s) which the tenderer proposes to use in the work. No change in the tendered rates will be accepted if the tender accepting authority does not accept the list of cement manufactures, given by the tenderer, fully or partially. The cement brought to the site for execution of work shall be in bags bearing manufacturer's name & ISI marking. Weight of cement in each bag shall be 50 kg. Samples of cement arranged by the contractor shall be taken by the Engineer- in-Charge and got tested in accordance with provisions of relevant BIS codes. In case the test results indicate that the cement arranged by the contractor does not conform to the relevant BIS codes, the same shall stand rejected and it shall be removed from the site by the contractor at his own cost within 7 days of written order from the Engineer-in-Charge to do so.

2.27 Special Conditions for Waterproofing and Testing

The contractor shall associate himself with the specialized firm, to be approved by the Engineer-in-Charge in writing, for water proofing treatment as contractor shall provide Guarantee Bond in the prescribed format for 10 years. After laying and jointing of pipes for PHE works contractor shall carry out Pressure test as per CPWD Specification 2019 to check the leakage and sustainability of whole pipe network system. Similarly after water proofing works and finalization of roof top surface/exposed surfaces, the entire surface thus treated shall be flooded with water by making kiarries with weak cement mortar, for a minimum period of two weeks.

2.28 Other Conditions

- a) All mass Reinforced Cement Concrete work shall be design mix concrete of specified grade and initial design mix shall be carried out from the Govt. approved Laboratory/NABL accredited lab/ NIT/IIT immediately after award of work. The Design Mix report shall be submitted to WAPCOS before commencement of the RCC works at site.
- b) The Contractor shall be responsible to co-ordinate with service provider/concerned authorities for cutting of trees, shifting of utilities and removal of encroachments etc. and making the site un-encumbered from the project construction area required for completion of work. This shall include initial and frequent follow up meetings/ actions/ discussions with each involved service provider/ concerned authorities. The contractor shall not be entitled for any additional compensation for delay in cutting of trees, shifting of utilities and removal of encroachments by the service provider/ concerned authorities.
- c) Contractor shall provide R.O. Plant sufficient for workers employed at site, his technical staff and site staff.
- d) Any cement slurry added over base surface (or) for continuation of concreting for better bond is deemed to have been in-built in the items and nothing extra shall be payable (or) extra cement considered in consumption on this account.
- e) No payment shall be made for any damage caused by rain, snowfall, flood or any other natural calamity, whatsoever during the execution of the work. The Contractor shall be fully responsible for any damage to the govt. property and work for which the payment has been advanced to him under the contract and he shall make good the same at his risk and cost. The Contractor shall be fully responsible for safety and security of his material, T&P, Machinery brought to the site by him.
- f) Wherever work is specified to be done or material procured through specialized agencies, their names shall be got approved well in advance from Engineer-in-Charge. Failure to do so shall not justify delay in execution of work. It is suggested that immediately after award of work, Contractor should negotiate with concerned specialist agencies and send their names for approval to Engineer-in-Charge. Any material procured without prior approval of Engineer-in-Charge in writing is liable to be rejected. Engineer-in-Charge reserves right to get the materials tested in laboratories of his choice before final acceptance. Nonstandard materials shall not be accepted.
- g) The construction joints shall be provided in predetermined locations & as per the approved drawings only.
- h) The Contractor shall invariably prepare the samples of finishing items i.e. flooring of different types, external & internal finishing i/c colour scheme of paint, tiles in dado, flooring in platforms & staircase, water supply & sanitary fittings and any other item as per direction of Project Manager, WAPCOS. The Contractor shall proceed with further finishing items only after getting the samples of these items approved in writing from Engineer-in-Charge. No extra claim whatsoever beyond the payments due at agreement rates will be entertained from the Contractor on this account.
- i) Contractor shall not divert any advance payments or part thereof for any work other than that needed for completion of the contracted work. All advance payments received as per terms of the contract (i.e., mobilization advance, secured advance against materials brought at site, secured advance against plant & machinery and/or for work done during interim stages, etc.) are required to be re-invested in the contracted work to ensure advance availability of resources in terms of materials, labour, plant & machinery needed for required pace of progress for timely completion of work.
- j) Any Circular/Guidelines/SOP issued by the Principal Employer/ Government during the progress/ execution of the construction work shall be followed by the contractor without any dispute. The contractor shall comply with proper and legal orders and directions of the local or public authority or municipality and abide by their rule and regulations and pay all fees and charges which he may be liable.
- k) All the modifications and any additional works (basic requirement after use of premises

by user) suggested by Principal Employer at the time of handing over of the project and after occupancy of premises by Principal Employer during Defect Liability Period must be taken up by contractor without any disputes.

- l) If any dispute/ hindrance may arise during construction due to any reason whatsoever, the contractor is not liable for any financial claim or damages due to such circumstances.
- m) If the work is carried out in more than one shift or during night, no claim on this account shall be entertained. The contractor has to take permission from the police & local authorities etc. if required for work during night hours. No claim / hindrance on this account shall be considered if work is not allowed during night time. The requisite supervision shall be made available by the WAPCOS along with necessary issue of material under joint custody.
- n) In case of any inconsistency between clauses, the clause favorable/ beneficiary to the project will prevail which will be decided by the Principal Employer and Employer.
- o) One sample room complete in all shape for each category, shall be prepared by the contractor and got approved from Engineer-in-charge in writing. The contractor shall be allowed to proceed with further rooms only after getting the sample room approved in writing from Engineer-in-charge. No extra claim whatsoever beyond the payments due at agreement rates will be entertained from the contractor on this account.
- p) It must be ensure that all materials to be used in work bear BIS certification mark. In cases where BIS certification system is available for a particular material/product but not even a single producer has so far approached BIS for certification the material can be used subject to the condition that it should confirm to CPWD specification and relevant BIS codes. In such case written approval of the Engineer-In-Charge may be obtained before use of such material in the work.
- q) In case of works where a ready mix concrete (RMC) is stipulated to be used from an approved source/manufacturer, cement register need not be maintained. However, the computerized dispatch slips that are sent with each dispatch of RMC shall be kept as record.

SECTION – VI

ANNEXURES

| | |
|-----------------|--|
| ANNEXURE - I | FORMAT FOR CONTRACT AGREEMENT AND LETTER OF AWARD |
| ANNEXURE - II | FORMAT FOR PERFORMANCE BANK GUARANTEE |
| ANNEXURE - III | FORMAT FOR MOBILIZATION ADVANCE PAYMENT BANK GUARANTEE |
| ANNEXURE - IV | FORMAT FOR INDENTURE FOR SECURED ADVANCES |
| ANNEXURE - V | FORMAT OF BANK GUARANTEE FOR EMD |
| ANNEXURE - VI | FORMAT FOR SEEKING EXTENSION OF TIME |
| ANNEXURE – VII | FORMAT OF GUARANTEE BOND /AFFIDAVIT FOR WORKS |
| ANNEXURE - VIII | CONTRACT FOR REMOVAL OF DEFECTS AFTER COMPLETION IN RESPECT OF WATER PROOFING WORKS |
| ANNEXURE – IX | FORMAT FOR GUARANTEE BONDS FOR ANTI-TERMITE TREATMENT |
| ANNEXURE – X | SAFETY CODES |
| ANNEXURE – XI | MODEL RULES FOR THE PROTECTION OF HEALTH AND SANITARY ARRANGEMENTS FOR WORKERS EMPLOYED BY CONTRACTORS |
| ANNEXURE – XII | CONTRACTOR'S LABOUR REGULATIONS |

ANNEXURE-I

(Format for "Contract" to be signed on Non-Judicial Stamp Paper of Rs. 100 by successful bidder)

CONTRACT AGREEMENT

This Contract made on the ___ day of ___ 20___ between WAPCOS Limited, a Company in corporate under Indian Company's Act and having its registered office at 5th floor, Kailash Building, 26, K. G. Marg, New Delhi (hereinafter called "WAPCOS" of the one part) and (Name of Contractor Firm & Address)_____ (hereinafter called "Contractor" of the other part).

WHEREAS the WAPCOS is desirous that Work known as "_____". (Herein after referred to as "Work/ Project") under the Tender no. _____ dated _____ should be executed by the Contractor AND WHEREAS by a Letter of Award No. _____ dated _____ issued by WAPCOS Limited and accepted by the contractor. WAPCOS Limited has accepted a Bid submitted by the Contractor for the execution and completion of such Work AND WHEREAS the Contractor has agreed to undertake such Work and furnish a Performance Security _____(details) pursuant to Tender conditions.

NOW THIS AGREEMENT WITNESSETH as follows;

In this Contract words and expressions shall have the same meanings as are respectively assigned to them in the Conditions of Contract hereinafter referred to.

The following documents shall be deemed to form and be read and construed as part of this Contract, viz;

- a) Tender Document no. _____ dtd. _____
- b) Letter of Award to Contractor by WAPCOS
- c) Documents furnished by the Contractor during Bidding process
- d) Corrigendum/Amendments, if any
- e) Clarifications / Correspondences, if any
- f) Any other documents as forming part of the contract

1. The aforesaid documents shall be taken as complementary and mutually explanatory of one another.
2. In consideration of the payment to be made by WAPCOS to the Contractor as indicated in this Contract, the Contractor hereby covenants with WAPCOS to execute and complete the Works in conformity, in all respects, with the provisions of the Contract.
3. WAPCOS hereby covenants to pay the Contractor in consideration of the execution and completion of the Works and the remedying of defects therein the Contract Price or such other sum as may become payable under the provisions of the contract at the time and in the manner prescribed by the Contract.

IN WITNESS whereof the parties hereto have caused this Agreement to be executed in accordance with Laws of India on the day, month & year indicated above.

SIGNED, SEALED AND DELIVERED

For and on behalf of the WAPCOS

For and on behalf of the Contractor

NAME _____
Designation

NAME _____
Designation

in the presence of witness:

in the presence of Witness

1 _____

1 _____

2 _____

2 _____

NOTE: Contractor shall submit the Original Power of Attorney on Non-Judicial Stamp Paper for this particular Work / Project, in the name of Person who will sign the Contract with WAPCOS after award of Work.

FORMAT FOR LETTER OF AWARD

No.

Date:.....

M/s(Name of successful Bidder)
..... (Address of successful bidder)
.....

Subject: Award Letter for Construction of Eklavya Model Residential School at Jaldega, District Simdega, Jharkhand

Reference: Tender No.

Dear Sir,

We are pleased to inform that work of “.....” is awarded to your firm, in cost of Rs. ----- excluding GST, according to submission of your technical & financial bids against referred tender for the subjected work.

| Project | Awarded Cost excluding GST |
|---|----------------------------|
| Construction of Eklavya Model Residential School at Jaldega, District Simdega, Jharkhand | Rs. |

1. The “Date of Commencement of Work” shall be 15 days after Date of Award or Handing over of Site whichever is later and accordingly, planning should be started for deploying manpower, resources as per Terms & Conditions of Tender document.
2. The tender document wholly accepted by you along with all related correspondences at the time of bidding shall form a part of this letter of award.
3. You are requested to submit the following as per Terms & Conditions of
 - Performance Security @5% of Tendered Value as per the form enclosed in the tender document before signing of the Agreement within 21 (Twenty One) days of the date of acceptance of the letter of award and sign the Contract Agreement.
 - Schedule Plan/ Bar chart to complete the work in stipulated time period.
 - Details of manpower to be deployed at site along with CVs
 - List of Lab Equipment required for the work for approval of Engineer-in charge.
4. The terms & conditions of the Work will be governed as mentioned in the tender document.

This letter of award is being issued to you in duplicate. You are requested to return the duplicate copy of the letter of award immediately duly signed and stamped as a token of your unequivocal acceptance and confirmation of the same.

Thanking You,

Yours faithfully,
**(Name & Designation
of the Tendering Authority)**

Annexure – II

(To be submitted on non-judicial stamp paper of Rs. 100)

FORMAT FOR PERFORMANCE BANK GUARANTEE

To,
The WAPCOS Limited,
76-C, Sector 18, Institutional Area
Gurugram, Haryana-122015.

In consideration of _____ (Employer's name) (hereinafter referred to as "the Employer") which expression shall, unless repugnant to the context or meaning thereof include its successors, administrators and assigns) having awarded to _____ (Contractor's name & address) (hereinafter referred to as "the Contractor" which expression shall unless repugnant to the context or meaning thereof, include its successors, administrators, executors and assigns) a contract, by issue of Employer's Notification of Award No. _____ dt. _____ and the same having been unequivocally accepted by the Contractor, resulting into a contract valued at Rs. _____ (Rupees _____ only) for **Construction of Eklavya Model Residential School at Jaldega, District Simdega, Jharkhand** (hereinafter called "the contract") and the Contractor having agreed to provide a Contract Performance Security for the faithful performance of the entire contract equivalent to Rs. _____ (Rupees _____ only) (5% of the said value of the Contract to the Employer).

We, _____ (name & address of bank) (hereinafter referred to as "the Bank" which expression shall, unless repugnant to the context or meaning thereof, include its successors, administrators, executors and assigns) do hereby guarantee and undertake to pay the Employer, on demand any or, all monies payable by the Contractor to the extent of Rs. _____ (Rupees _____ only) as aforesaid at any time upto _____ without any demur, reservation, contest, recourse or protest and/or without any reference to the Contractor or court. Any such demand made by the Employer on the bank shall be conclusive and binding notwithstanding any difference between the Employer and the Contractor or any dispute pending before any Court, Tribunal, Arbitrator or any other authority. The Bank undertakes not to revoke this guarantee during its currency without previous consent of the Employer and further agrees that the guarantee herein contained shall continue to be enforceable till the Employer discharges this guarantee.

We the said Bank further agree that the guarantee herein contained shall remain in full force and effect during the period that would be taken for the performance of the said Contract and that it shall continue to be enforceable till all the dues of the Employer under or by virtue of the said contract have been fully paid and its claims satisfied or discharged or till the Employer certifies that the terms and conditions of the said Contract have been fully and properly carried out by the said Contractor and accordingly discharges the guarantee.

The Employer shall have the fullest liberty without affecting in any way the liability of the Bank under this guarantee, from, time to time to extend the time for performance of the Contract by the Contractor. The Employer shall have the fullest liberty without affecting this guarantee, to postpone from time to time the exercise of any powers vested in them or of any right which they might have against the Contractor and to exercise the same at any time in any manner and either to enforce or to forbear to enforce any covenants, contained or implied, in the Contract between the Employer and the Contractor or any other course or remedy or security available to the Employer. The bank shall not be released of its obligations under these presents by any exercise by the Employer of its liberty with reference to the matters aforesaid or any of them or by reason of any other act or forbearance or other acts of omission or commission on the part of the Employer or any other indulgence shown by the Employer or by any

other matter or thing whatsoever which under law would but for this provision, have the effect of relieving the Bank. The guarantee shall not be affected by a change in the constitution of the bank or of the employer.

The bank also agrees that the Employer at its option shall be entitled to enforce this Guarantee against the Bank as a principal debtor, in the first instance, without proceeding against the Contractor and notwithstanding any security or other guarantee that the Employer may have in relation to the Contractor's liabilities.

We The Said Bank do hereby declare that we have absolute and unconditional power to issue this guarantee in your favour under the Memorandum and Articles of Association or such other constitutional documents of the Bank and the undersigned have full power to execute this guarantee under the Power of Attorney / Post Approval Authorization dated _____ of the bank granted to him / us by the Bank. We the said bank do hereby declare and undertake that your claim under the guarantee shall not be affected by any deficiency or other defect in the powers of the bank or its officials and the guarantee shall be deemed to have been issued as if the bank and its officials have all the powers and authorization to give this guarantee on behalf of the bank.

We the said bank do hereby certify the genuineness and appropriateness of the Stamp paper and stamp value used for issuing the guarantee. We the said bank do hereby declare and undertake that your claim under the guarantee shall not be affected by any deficiency or other defect in the stamp paper or its stamp value.

We the said bank do hereby declare that our payments hereunder shall be made to you , free and clear of and without and deduction, reduction on account of any reasons including any and all present and future taxes, levies, charges of withholding whatsoever imposed or collected with respect thereto.

Notwithstanding anything contained hereinabove our liability under this guarantee is restricted to Rs. _____(Rupees _____ only) and it shall remain in force upto and including _____ and shall be extended from time to time for such period as may be desired by M/s WAPCOS Limited to whom this bank guarantee has been given.

Notwithstanding anything contained herein

- i) Our liability under this guarantee shall not exceed Rs. _____ (Rupees _____ only);
- ii) This bank guarantee shall be valid upto _____; and
- iii) our liability to make payment shall arise and we are liable to pay the guaranteed amount or any part thereof under this guarantee, only and only if you serve upon us a written claim or demand in terms of the guarantee on or before _____ (**indicate a date twelve month after validity of Guarantee**)

Dated this _____ day of _____ at New Delhi.

Authorized Signatory of Bank

Signature

Signature

Name.....

Name.....

Signature Code/ S.S no.

Signature Code/ S.S no.

.....

ANNEXURE – III

(To be submitted on non-judicial stamp paper of Rs. 100)

FORMAT FOR MOBILIZATION ADVANCE PAYMENT BANK GUARANTEE

To,
The WAPCOS Limited,
76-C, Sector 18, Institutional Area
Gurugram, Haryana-122015

In consideration of WAPCOS LTD. (hereinafter referred to as “the Employer”) which expression shall, unless repugnant to the context or meaning thereof include its successors, administrators and assigns) having awarded to _____ (Contractor’s name) with its Registered /Head Office at _____(hereinafter referred to as “the Contractor” which expression shall unless repugnant to the context or meaning thereof, include its successors, administrators, executors and assigns) a contract, by issue of Employer’s Notification of Award No. _____ dt. _____ and the same having been unequivocally accepted by the Contractor, resulting into a contract _____ valued _____ at _____ Rs. _____ (Rupees _____ only) for _____ (hereinafter called “the contract”) and the Employer having agreed to make an advance payment to the Contractor for performance of the above Contract amounting to Rs. _____ (Rupees _____ only) as an advance against bank guarantee to be furnished by the Contractor.

We, _____ (name & address of bank) having its Head Office at _____ (hereinafter referred to as “the Bank” which expression shall, unless repugnant to the context or meaning thereof, include its successors, administrators, executors and assigns) do hereby guarantee and undertake to pay the Employer immediately on demand any or, all monies payable by the Contractor to the extent of Rs. _____ (Rupees _____ only) as aforesaid at any time upto _____ without any demur, reservation, contest, recourse or protest and/or without any reference to the Contractor. Any such demand made by the Employer on the bank shall be conclusive and binding notwithstanding any difference between the Employer and the Contractor or any dispute pending before any Court, Tribunal, Arbitrator or any other authority. We agree that the Guarantee herein contained shall be irrevocable and shall continue to be enforceable till the Employer discharges this guarantee. We further agree that no change in the constitution of the Bank or of the Employer shall affect this guarantee. The Employer shall have the fullest liberty without affecting in any way the liability of the Bank under this guarantee, from time to time, to vary the advance or to extend the time for performance of the Contract by the Contractor. The Employer shall have the fullest liberty without affecting this guarantee, to postpone from time to time the exercise of any powers vested in them or of any right which they might have against the Contractor and to exercise the same at any time in any manner, and either to enforce or to forbear to enforce any covenants, contained or implied, in the Contract between the Employer and the Contractor or any other course or remedy or security available to the Employer. The bank shall not be released of its obligations under these presents by any exercise by the Employer of its liberty with reference to the matters aforesaid or any of them or by reason of any other act or forbearance or other acts of omission or commission on the part of the Employer or any other indulgence shown by the Employer or by any other matter or thing whatsoever which under law would but for this provision, have the effect of relieving the Bank.

The bank also agrees that the Employer at its option shall be entitled to enforce this Guarantee against the Bank as a principal debtor, in the first instance without proceeding against the Contractor and notwithstanding any security or other guarantee that the Employer may have in relation to the

Contractor's liabilities.

We the Said Bank do hereby declare that we have absolute and unconditional power to issue this guarantee in your favour under the Memorandum and Articles of Association or such other constitutional documents of the Bank and the undersigned have full power to execute this guarantee under the Power of Attorney/ Post Approval Authorization dated _____ of the bank granted to him / us by the Bank. We the said bank do hereby declare and undertake that your claim under the guarantee shall not be affected by any deficiency or other defect in the powers of the bank or its officials and the guarantee shall be deemed to have been issued as if the bank and its officials have all the powers and authorization to give this guarantee on behalf of the bank.

We the said bank does hereby certify the genuineness and appropriateness of the Stamp paper and stamp value used for issuing the guarantee. We the said bank does hereby declare and undertake that your claim under the guarantee shall not be affected by any deficiency or other defect in the stamp paper or its stamp value.

We the said bank do hereby declare that our payments hereunder shall be made to you , free and clear of and without and deduction, reduction on account of any reasons including any and all present and future taxes, levies, charges of withholding whatsoever imposed or collected with respect thereto.

Notwithstanding anything contained hereinabove our liability under this guarantee is limited to Rs. _____ (Rupees _____ only) and it shall remain in force upto and including _____ and shall be extended from time to time for such period (not exceeding one year), as may be desired by M/s _____ on whose behalf this bank guarantee has been given.

Notwithstanding anything contained herein

- i) Our liability under this guarantee shall not exceed Rs. _____ (Rupees _____ only);
- ii) This bank guarantee shall be valid upto _____ and
- iii) our liability to make payment shall arise and we are liable to pay the guaranteed amount or any part thereof under this guarantee, only and only if you serve upon us a written claim or demand in terms of the guarantee on or before _____ (**indicate a date twelve months after the validity of the guarantee**).

Dated this _____ day of _____ at.....

Authorized Signatory of Bank

Signature

Signature

Name.....

Name.....

Signature Code/ S.S no.

**Signature Code/ S.S no.
.....**

ANNEXURE-IV

(On non-judicial stamp paper of Rs. 100 duly attested by Notary / Magistrate)

FORMAT FOR INDENTURE FOR SECURED ADVANCES

THIS INDENTURE made the..... day of20..... BETWEEN (hereinafter called the Contractor which expression shall where the context so admits or implies be deemed to include his executors administrators and assigns) of the one part and the WAPCOS (hereinafter called the WAPCOS which expression shall where the context so admits or implies be deemed to include his successors in office and assigns) of the other part.

WHEREAS by an agreement dated..... (hereinafter called the said agreement) the Contractor has agreed AND WHEREAS the Contractor has applied to the WAPCOS that he may be allowed advances on the security of materials absolutely belonging to him and brought by him to the site of the works the subject of the said agreement for use in the construction of such of the works as he has undertaken to execute at rates fixed for the finished work (inclusive of the cost of materials and labour and other charges) AND WHEREAS the WAPCOS has agreed to advance to the Contractor the sum of Rupees on the security of materials the quantities and other particulars of which are detailed in Accounts of Secured Advances attached to the Running Account Bill for the said works signed by the Contractor onand the WAPCOS has reserved to himself the option of making any further advance or advances on the security of other materials brought by the Contractor to the site of the said works. Now THIS INDENTURE WITNESSETH that in pursuance of the said agreement and in consideration of the sum of Rupeeson or before the execution of these presents paid to the Contractor by the WAPCOS (the receipt whereof the Contractor doth hereby acknowledge) and of such further advances (if any) as may be made to him as aforesaid the Contractor doth hereby covenant and agree with the WAPCOS and declare as follows: -

- (1) That the said sum of Rupeesso advanced by the WAPCOS to the Contractor as aforesaid and all or any further sum or sums advanced as aforesaid shall be employed by the Contractor in or towards expediting the execution of the said works and for no other purpose whatsoever.
- (2) That the materials detailed in the said Account of Secured Advances which have been offered to and accepted by the WAPCOS as security are absolutely the Contractor's own property and free from encumbrances of any kind and the contractor will not make any application for or receive a further advance on the security of materials which are not absolutely his own property and free from encumbrances of any kind and the Contractor indemnifies the WAPCOS against all claims to any materials in respect of which an advance has been made to him as aforesaid.
- (3) That the materials detailed in the said Account of Secured Advances and all other materials on the security of which any further advance or advances may hereafter be made as aforesaid (hereinafter called the said materials) shall be used by the Contractor solely in the execution of the said works in accordance with the directions of the Divisional Officer Division (hereinafter called the Divisional Officer) and in the term of the said agreement.
- (4) That the Contractor shall make at his own cost all necessary and adequate arrangements for the proper watch, safe custody and protection against all risks of the said materials and that until used in construction as aforesaid the said materials shall remain at the site of the said works in the Contractor's custody and on his own responsibility and shall at all times be open to inspection by the Divisional Officer or any officer authorised by him. In the event of the said materials or any part thereof being stolen, destroyed or damaged or becoming deteriorated in a greater degree than is due to reasonable use and wear thereof the Contractor will forthwith replace the same

- with other materials of like quality or repair and make good the same as required by the Divisional Officer.
- (5) That the said materials shall not on any account be removed from the site of the said works except with the written permission of the Divisional Officer or an officer authorised by him on that behalf.
 - (6) That the advances shall be repayable in full when or before the Contractor receives payment from the WAPCOS of the price payable to him for the said works under the terms and provisions of the said agreement. Provided that if any intermediate payments are made to the Contractor on account of work done than on the occasion of each such payment the WAPCOS will be at liberty to make a recovery from the Contractor's bill for such payment by deducting there from the value of the said materials then actually used in the construction and in respect of which recovery has not been made previously, the value for this purpose being determined in respect of each description of materials at the rates at which the amounts of the advances made under these presents were calculated.
 - (7) That if the Contractor shall at any time make any default in the performance or observance in any respect of any of the terms and provisions of the said agreement or of these presents the total amount of the advance or advances that may still be owing to the WAPCOS shall immediately on the happening of such default be repayable by the Contractor to the WAPCOS together with interest thereon at twelve per cent per annum from the date or respective dates of such advance or advances to the date of repayment and with all costs charges, damages and expenses incurred by the WAPCOS in or for the recovery thereof or the enforcement of this security or otherwise by reason of the default of the Contractor and the Contractor hereby covenants and agrees with the WAPCOS to repay and pay the same respectively to him accordingly.
 - (8) That the Contractor hereby charges all the said materials with the repayment to the WAPCOS of the said sum of Rupeesand any further sum or sums advanced as aforesaid and all costs charges, damages and expenses payable under these presents PROVIDED ALWAYS and it is hereby agreed and declared that notwithstanding anything in the said agreement and without prejudice to the powers contained therein if and whenever the covenant for payment and repayment herein before contained shall become enforceable and the money owing shall not be paid in accordance therewith the WAPCOS may at any time thereafter adopt all or any of the following courses as he may deem best :-
 - (a) Size and utilize the said materials or any part thereof in the completion of the said works on behalf of the Contractor in accordance with the provisions in that behalf contained in the said agreement debiting the Contractor with the actual cost of effecting such completion and the amount due in respect of advances under these presents and crediting the Contractor with the value of work done as if he had carried it out in accordance with the said agreement and at the rates thereby provided. If the balance is against the Contractor he is to pay same to the WAPCOS on demand.
 - b) Remove and sell by public auction the seized materials or any part thereof and out of the moneys arising from the sale retain all the sums aforesaid repayable or payable to the WAPCOS under these presents and pay over the surplus (if any) to the Contractor.
 - (c) Deduct all or any part of the moneys owing out of the security deposit or any sum due to the Contractor under the said agreement.
 - (9) That except in the event of such default on the part of the Contractor as aforesaid interest on the said advance shall not be payable.
 - (10) That in the event of any conflict between the provisions of these presents and the said agreement the provisions of these presents shall prevail and in the event of any dispute or difference arising over the construction or effect of these presents the settlement of which has not been herein before expressly provided for the same shall be finally resolved as per provisions of clause 25 of the contract.

In witness whereof the said Contractor and WAPCOS by the order and under the direction of the WAPCOS have hereunto set their respective hands the day and year first above written.

SIGNED, SEALED AND DELIVERED

For and on behalf of the Contractor

For and on behalf of the WAPCOS

NAME _____

NAME_____

Designation _____

Designation_____

in the presence of witness:

1 _____

2 _____

in the presence of Witness

1 _____

2 _____

ANNEXURE-V

(To be submitted on non-judicial stamp paper of Rs. 100)

FORMAT FOR BANK GUARANTEE OF EMD

To,
The WAPCOS Limited,
76-C, Sector 18, Institutional Area
Gurugram, Haryana-122015.

WHEREAS, M/s having their Registered/Head Office at (hereinafter called “the Bidder”) has submitted his Bid dated for the [hereinafter called “the Bid”] to M/s WAPCOS Limited (hereinafter called the Employer)

KNOW ALL PEOPLE by these presents that we (name of the Bank) having our head office at (hereinafter called “the Bank”) are bound unto Employer in the sum of for which payment well and truly to be made to the Employer, the Bank binds itself, its successors and assigns by these presents.

SEALED with the Common Seal of the said Bank this day ofmonth..... year.

THE CONDITIONS of this obligation are:

(1) If after Bid opening the Bidder withdraws his bid during the period of Bid validity specified;

OR

(2) If the Bidder having been notified of the acceptance of his bid by during the period of Bid Validity:

We undertake to pay to the up to the above amount upon receipt of his first written demand, without the Employer having to substantiate his demand, provided that in his demand the Bidder will note that the amount claimed by him is due to him owing to the occurrence of one or any of the above mentioned two conditions and specify the occurred condition or conditions.

This Guarantee will remain in force up to and including the date after the deadline for submission of Bids as is stated in the instructions to Bidders or as it may be extended by the notice of which extension(s) to the Bank is hereby waived and notice to the bidder would constitute sufficient notice to the Bank. Any demand in respect of this guarantee should reach the Bank not later than the above date.

Notwithstanding anything contained herein

- i) Liability under this guarantee shall not exceed
- ii) This bank guarantee shall be valid upto and;
- iii) Our liability to make payment shall arise and we are liable to pay the guaranteed amount or any part thereof under this guarantee only and only if you serve upon us a written claim or demand in terms of the guarantee on or before (indicate a period twelve months after the date of issue of Bank Guarantee).

Dated this _____ day of _____ at.....

Authorized Signatory of Bank

Signature

Signature

Name.....

Name.....

Signature Code/ S.S no.

Signature Code/ S.S no.

ANNEXURE-VI

(To be submitted on Contractor's original Letter Head)

FORMAT FOR SEEKING EXTENSION OF TIME

1. Name of Contractor:
2. Name of work:
3. Agreement No. and Date:
4. Date of commencement of work as per Agreement:
5. Period and Stipulated date of completion as per Agreement:
6. Period for which extension of time already given:

| Extension | Period | Reasons Stated earlier for seeking EoT |
|-------------------------------|---------------|---|
| (a) 1 st extension | | |
| (b) 2 nd extension | | |
| (c) 3 rd extension | | |
| (d) 4 th extension | | |
| (e) 5 th extension | | |

9) Reasons for present extension

10) Period for which extension is applied for

It is understood that we will not claim any additional cost due to above extension of time and also understand that WAPCOS have rights to act in accordance with provisions in relevant clauses of Contract Agreement.

Dated.....

Contractor's Signature and Stamp

Annexure – VII

(On Rs. 100 non- Judicial Stamp Paper duly attested by Notary / Magistrate)

FORMAT FOR GUARANTEE BONDS

To Be Executed by Contractor for Structural Stability, Removal of Defects after completion of work

The Supplementary Agreement made this ____ day of _____ 20__ between (Name of Contractor firm & address) _____ (hereinafter called the CONTRACTOR / GUARANTOR of the one part) and the WAPCOS LIMITED, 5th floor, Kailash Building, 26, K. G. Marg, New Delhi (hereinafter called WAPCOS of the other part) for the Work **Construction of Eklavya Model Residential School at Jaldega, District Simdega, Jharkhand** in respect of Contract Agreement (hereinafter called the “Original Agreement” signed between(Name of Contractor firm) and WAPCOS on..... dated, whereby the contractor inter alia, under look to render the work in the said contract recited structurally stable workmanship and use of sound materials.

AND WHEREAS THE GUARANTOR agreed to give a guarantee to the effect that the said work will remain structurally stable and guarantee against faulty workmanship, manufacturing defects of materials etc.

NOW THE GUARANTOR hereby guarantee that work executed by him will remain structurally stable, for the minimum life of ten years, to be reckoned from the date of start of Defect Liability Period or Maintenance Period which ever is later, prescribed in the Contract.

The decision of the WAPCOS with regard to nature and cause of defects shall be final. During the period of guarantee the Guarantor shall make good all defects to the satisfaction of the WAPCOS calling upon him to rectify the defects, failing which the work shall be got done by the WAPCOS by some other agencies at the Guarantor’s cost and risk. The decision of the WAPCOS as to the cost payable by the Guarantor shall be final and binding.

That if the Guarantor fails to make good all the defects, commits breach thereunder then the guarantor will indemnify the Principal and his successor against all loss, damage cost expense or otherwise which may be incurred by him by reason of any default on the part of the GUARANTOR in performance and observance of this Supplementary Agreement. As to the amount of loss and / or damage and / or cost incurred by the WAPCOS the decision of the WAPCOS will be final and binding.

IN WITNES WHEREOF those presents have been executed by the GUARANTOR(Name and Designation who sign the Original Contract Agreement) on behalf of(Name of Contractor Firm) and WAPCOS on the day, month and year first above written.

SIGNED, SEALED AND DELIVERED

For and on behalf of the Contractor

For and on behalf of the WAPCOS

NAME _____

NAME _____

Designation _____

Designation _____

in the presence of witness:

in the presence of Witness

1 _____

1 _____

2 _____

2 _____

Annexure – VIII

(On Rs. 100 non- Judicial Stamp Paper duly attested by Notary / Magistrate)

FORMAT FOR GUARANTEE BONDS

To Be Executed by Contractor for Water Proofing after Completion of Work

This Agreement made on this ____ day of _____ 20__ between _____ (Name of Contractor firm & address) _____ (hereinafter called the CONTRACTOR / GUARANTOR of the one part) and the _____ (hereinafter called Principal Employer OR Employer of the other part) for Water proofing Works of **Construction of Eklavya Model Residential School at Jaldega, District Simdega, Jharkhand**

WHEREAS This Agreement is Supplementary, to a Contract (hereinafter called the Contract) Contract no. _____ dated _____ and made between the _____ (Name of Contractor) and WAPCOS LIMITED, 5th floor, Kailash Building, 26, K. G. Marg, New Delhi, whereby the contractor, inter alia, undertook to render the buildings and structures in the contract recited completely water and leak-proof for Toilets, Shower , Under Ground Tank, Roof, Over Head Tank, Basement and any other allied areas of building.

AND WHEREAS THE GUARANTOR agreed to give a guarantee to the effect that the said structures will remain water and leak-proof for **ten years** from the date after the Defect Liability Period or Maintenance Period which ever is later, prescribed in the contract. NOW THE GUARANTOR hereby guarantees that water proofing treatment given by him will render the structures completely leak proof and the minimum life of such water proofing treatment shall be **ten years** to be reckoned from the date after the Defect Liability Period / Maintenance Period which ever is later, prescribed in the contract.

Provided that the Guarantor will not be responsible for the leakage caused by earthquake or structural defects or misuse of roof or alteration and for such purpose:

- a. Misuse of roof shall mean any operation which will damage proofing treatment, like chopping of firewood and things of the same nature which might cause damage to the roof.
- b. Alteration shall mean construction of an additional storey or a part of the roof or construction adjoining to existing roof whereby proofing treatment is removed in parts.
- c. The decision of the Principal Employer with regard to cause of leakage/seepage shall be final.

During this period of guarantee the Guarantor shall make good all defects and in case of any defect being found, render the building water proof to the satisfaction of the Principal Employer at his cost and shall commence the work for the rectification within seven days from the date of issue of the notice from the Principal Employer calling upon him to rectify the defects failing which the work shall be done by the Principal Employer by some other agency at the GUARANTOR's risk and cost. The decision of the Principal Employer as to the cost payable by the Guarantor shall be final and binding. That if Guarantor fails to make good all defects or commits breach there under then the Guarantor will indemnify the principal and his successors against all loss, damage, cost expense otherwise which may be incurred by him by reason of any default on the part of the GUARANTOR in performance and observance of this Supplementary Agreement. As to the amount of loss and/or damage and/or cost incurred by the Principal Employer the decision of the owner will be final and binding on the parties.

IN WITNES WHEREOF those presents have been executed by the GUARANTOR(Name and Designation who sign the Contract) on behalf of(Name of Contractor Firm) and Principal Employer on the day, month and year first above written.

SIGNED, SEALED AND DELIVERED

For and on behalf of the Contractor
Employer

For and on behalf of the Principal

NAME _____
Designation

NAME _____
Designation

in the presence of witness:

in the presence of Witness

_1 _____

_1 _____

2 _____

2 _____

2 _____

2 _____

ANNEXURE VIII (a)

FORM OF BANK GUARANTEE BOND FOR WATER PROOFING WORK

1. In considerable of the(Name of Principal Employer) (hereinafter called “The Owner”) having agreed to exempt..... (Hereinafter called the said contractor(s)) from the demand, under the terms and conditions of the Agreement No..... dated.....Made between and For the work of..... (hereinafter called “The said Agreement”) security deposit for the due fulfillment by the said contractor(s) of the terms & conditions contained in the said Agreements for the work of Anti water proofing work on production of an irrevocable Bank Guarantee for Rs. 10 Lakhs for ten years we (Indicate the name of the bank) (Hereinafter referred to as “the Bank) hereby undertake to pay to the Owner an amount not exceeding Rs.(Rupeesonly) on demand by the Owner
2. We..... (indicate the name of the bank) do hereby undertake to pay the amounts due and payable under this Guarantee without any demure, merely on a demand from Principal Employer stating that the amount claimed is required to meet the recoveries due or likely to be due from the said contractor(s). Any such demand made on the Bank shall be conclusive as regards the amount due and payable by the bank under the Guarantee. However, our liability under this guarantee shall be restricted to an amount not exceeding Rs.(Rupeesonly).
3. We..... (indicate the name of the bank) further undertake to pay to Principal Employer any money so demanded notwithstanding any dispute or disputes raised by the contractor(s) in any suit or proceeding pending before any court or Tribunal relating thereto, our liability under this present being absolute and unequivocal.
The payment so made by as under this bond shall be a valid discharge of our liability for payment there under and the contractor(s) shall have no claim against us for making such payment.
4. We..... (indicate the name of the Bank) further agree that the guarantee hereinafter contained shall remain in full force and effect during the period that would be taken for the performance of the said agreement and that it shall continue to be enforceable till all the dues of Principal Employer under or by virtue of the said agreement have been fully paid and its claims satisfied or discharged or till Principal Employer certified that the terms and condition of the said agreement have been fully and properly carried out by the said contractor(s) and accordingly discharges this guarantee.
5. We..... (indicate name of the bank) further agree with Principal Employer that Principal Employer shall have the fullest liberty without our consent and without effecting in any manner our obligations hereunder to vary any of the terms and conditions of the said agreement or to extend time of performance by the said contractor(s) from time to time or to postpone for any time or from time to time any of the powers exercisable by Principal Employer against the said contractor(s) and to for bear or enforce any of the terms and conditions relating to the said agreement and we shall not be relieved from our liability by reason of any such variation, or extension being granted to the said contractors(s) or for any bearance, act of commission of the part of Principal Employer or any indulgence by Principal Employer to the said contractor(s) or by any such matter of thing whatsoever which under the law relating to sureties would, but for this provision, have effect of so relieving us.
6. This guarantee will not be discharged due to the change in the constitution of Bank or the contractor(s).

7. We..... (indicate the name of the Bank) lastly undertake not to revoke this guarantee except with the previous consent of Principal Employer in writing
8. This guarantee shall be valid upto unless extended on demand by Principal Employer. Notwithstanding anything mentioned above, our liability against this guarantee is restricted to Rs.(Rupeesonly) and unless a claim in writing is lodged with us within six months of the date of expiry or the extended date of expiry of this guarantee all our liabilities under this guarantee shall stand discharged

Dated this _____ day of _____ at.....

Authorized Signatory of

Bank

Signature

Signature

Name.....

Name.....

Signature Code/ S.S no.

Signature Code/ S.S no.

Annexure – IX

(On Rs. 100 non- Judicial Stamp Paper duly attested by Notary / Magistrate)

FORMAT FOR GUARANTEE BONDS FOR ANTI-TERMITE TREATMENT
To Be Executed by Contractor for Anti Termite Treatment after Completion of Work

This Agreement made on this ____ day of _____ 20__ between _____ (Name of Contractor firm & address) _____ (hereinafter called the CONTRACTOR / GUARANTOR OR Employer of the one part) and the _____ (hereinafter called Principal Employer of the other part) for Anti Termite Treatment Works for _____ (Name of Project)

WHEREAS This Agreement is Supplementary, to a Contract (hereinafter called the Contract) Contract no. _____ dated _____ and made between the _____ (Name of Contractor) and WAPCOS LIMITED, 5th floor, Kailash Building, 26, K. G. Marg, New Delhi, whereby the contractor, inter alia, undertook to render the wooden work in the said contract recited completely Termite proof.

THE GUARANTOR hereby guarantee that the anti-termite treatment given by him will render the wooden works completely Termite proof and the minimum life of such Anti-Termite treatment shall be five years to be reckoned from the from the date after the Defect Liability Period or Maintenance Period which ever is later, prescribed in the contract.

During the period of guarantee the Guarantor shall make good all defects and in case of any defects being found render the wooden works termite proof to the satisfaction of the Principal Employer at his cost and shall commence the work for such rectification within seven days from the date of issue of notice from the Principal Employer calling upon him to rectify the defects, failing which the work shall be got done by the Principal Employer through some other Agency at the Guarantor’s cost and risk. The decision of the Principal Employer as to the cost payable by the Guarantor shall be final and binding.

That if the guarantor fails to execute the Anti-termite works, or commits breach thereunder then the guarantor will indemnify the Principal and his successor against all loss, damage, cost of expenses or otherwise which may be incurred by him by reason of any of any default on the part of the GUARANTOR in performance and observance of this Supplementary Agreement. As to the amount of loss and / or cost incurred by the Principal Employer on the decision of the Principal Employer will be final and binding.

IN WITNES WHEREOF those presents have been executed by the GUARANTOR(Name and Designation who sign the Contract) on behalf of(Name of Contractor Firm) and Principal Employer on the day, month and year first above written.

SIGNED, SEALED AND DELIVERED

For and on behalf of the Contractor
Employer

NAME _____

Designation _____

in the presence of witness:

_1 _____

2 _____

For and on behalf of the Principal

NAME _____

Designation _____

in the presence of Witness

_1 _____

2 _____

ANNEXURE – X

SAFETY CODES

1. Suitable scaffolds should be provided for workmen for all works that cannot safely be done from the ground, or from solid construction except such short period work as can be done safely from ladders. When a ladder is used, an extra mazdoor shall be engaged for holding the ladder and if the ladder is used for carrying materials as well suitable footholds and hand-hold shall be provided on the ladder and the ladder shall be given an inclination not steeper than $\frac{1}{4}$ to $1\frac{1}{4}$ (horizontal and 1 vertical).
2. Scaffolding of staging more than 3.6 m (12ft.) above the ground or floor, swung or suspended from an overhead support or erected with stationary support shall have a guard rail properly attached or bolted, braced and otherwise secured at least 90 cm. (3ft.) high above the floor or platform of such scaffolding or staging and extending along the entire length of the outside and ends thereof with only such opening as may be necessary for the delivery of materials. Such scaffolding or staging shall be so fastened as to prevent it from swaying from the building or structure.
3. Working platforms, gangways and stairways should be so constructed that they should not sag unduly or unequally, and if the height of the platform or the gangway or the stairway is more than 3.6 m (12ft.) above ground level or floor level, they should be closely boarded, should have adequate width and should be suitably fastened as described in (2) above.
4. Every opening in the floor of a building or in a working platform shall be provided with suitable means to prevent the fall of person or materials by providing suitable fencing or railing whose minimum height shall be 90 cm. (3ft.).
5. Safe means of access shall be provided to all working platforms and other working places. Every ladder shall be securely fixed. No portable single ladder shall be over 9m. (30ft.) in length while the width between side rails in rung ladder shall in no case be less than 29 cm. (11½") for ladder upto and including 3 m. (10 ft.) in length. For longer ladders, this width should be increased at least $\frac{1}{4}$ " for each additional 30 cm. (1 foot) of length. Uniform step spacing of not more than 30 cm shall be kept. Adequate precautions shall be taken to prevent danger from electrical equipment. No materials on any of the sites or work shall be so stacked or placed as to cause danger or inconvenience to any person or the public. The contractor shall provide all necessary fencing and lights to protect the public from accident and shall be bound to bear the expenses of defence of every suit, action or other proceedings at law that may be brought by any person for injury sustained owing to neglect of the above precautions and to pay any damages and cost which may be awarded in any such suit; action or proceedings to any such person or which may, with the consent of the contractor, be paid to compensate any claim by any such person
6. (a) Excavation and Trenching - All trenches 1.2 m. (4ft.) or more in depth, shall at all times be supplied with at least one ladder for each 30 m. (100ft.) in length or fraction thereof, Ladder shall extend from bottom of the trench to at least 90 cm. (3ft.) above the surface of the ground. The side of the trenches which are 1.5 m. (5ft.) or more in depth shall be stepped back to give suitable slope or securely held by timber bracing, so as to avoid the danger of sides collapsing. The excavated materials shall not be placed within 1.5 m. (5ft.) of the edges of the trench or half of the depth of the trench whichever is more. Cutting shall be done from top to bottom. Under no circumstances, undermining or undercutting shall be done.
(b) Safety Measures for digging bore holes:-
 - i. If the bore well is successful, it should be safely capped to avoid caving and collapse of the bore well. The failed and the abandoned ones should be completely refilled to avoid caving and collapse;

- ii. During drilling, Sign boards should be erected near the site with the address of the drilling contractor and the Engineer-in-charge of the work;
 - iii. Suitable fencing should be erected around the well during the drilling and after the installation of the rig on the point of drilling, flags shall be put 50m all round the point of drilling to avoid entry of people;
 - iv. After drilling the borewell, a cement platform (0.50m x 0.50m x 1.20m) 0.60m above ground level and 0.60m below ground level should be constructed around the well casing;
 - v. After the completion of the borewell, the contractor should cap the bore well properly by welding steel plate, cover the bore well with the drilled wet soil and fix thorny shrubs over the soil. This should be done even while repairing the pump;
 - vi. After the borewell is drilled the entire site should be brought to the ground level.
7. Demolition - Before any demolition work is commenced and also during the progress of the work,
- (i) All roads and open areas adjacent to the work site shall either be closed or suitably protected.
 - (ii) No electric cable or apparatus which is liable to be a source of danger or a cable or apparatus used by the operator shall remain electrically charged.
 - (iii) All practical steps shall be taken to prevent danger to persons employed from risk of fire or explosion or flooding. No floor, roof or other part of the building shall be so overloaded with debris or materials as to render it unsafe.
8. All necessary personal safety equipment as considered adequate by the Engineer-in-Charge should be kept available for the use of the person employed on the site and maintained in a condition suitable for immediate use, and the contractor should take adequate steps to ensure proper use of equipment by those concerned. The following safety equipment shall invariably be provided.
- (i) Workers employed on mixing asphaltic materials, cement and lime mortars shall be provided with protective footwear and protective goggles.
 - (ii) Those engaged in white washing and mixing or stacking of cement bags or any material which is injurious to the eyes, shall be provided with protective goggles.
 - (iii) Those engaged in welding works shall be provided with welder's protective eyeshields.
 - (iv) Stone breaker shall be provided with protective goggles and protective clothing and seated at sufficiently safe intervals.
 - (v) When workers are employed in sewers and manholes, which are in active use, the contractors shall ensure that the manhole covers are opened and ventilated atleast for an hour before the workers are allowed to get into the manholes, and the manholes so opened shall be cordoned off with suitable railing and provided with warning signals or boards to prevent accident to the public. In addition, the contractor shall ensure that the following safety measure are adhered to :-
 - (a) Entry for workers into the line shall not be allowed except under supervision of the JE or any other higher officer.
 - (b) At least 5 to 6 manholes upstream and downstream should be kept open for at least 2 to 3 hours before any man is allowed to enter into the manhole for working inside.
 - (c) Before entry, presence of Toxic gases should be tested by inserting wet lead acetate paper which changes colour in the presence of such gases and gives indication of their presence.
 - (d) Presence of Oxygen should be verified by lowering a detector lamp into the manhole. In case, no Oxygen is found inside the sewer line, workers should be sent only with Oxygen kit.
 - (e) Safety belt with rope should be provided to the workers. While working inside the manholes, such rope should be handled by two men standing outside to enable him to be pulled out during emergency.
 - (f) The area should be barricaded or cordoned off by suitable means to avoid mishaps of any kind. Proper warning signs should be displayed for the safety of the public

- whenever cleaning works are undertaken during night or day.
- (g) No smoking or open flames shall be allowed near the blocked manhole being cleaned.
 - (h) The malba obtained on account of cleaning of blocked manholes and sewer lines should be immediately removed to avoid accidents on account of slippery nature of the malba.
 - (i) Workers should not be allowed to work inside the manhole continuously. He should be given rest intermittently. The Engineer-in-Charge may decide the time up to which a worker may be allowed to work continuously inside the manhole.
 - (j) Gas masks with Oxygen Cylinder should be kept at site for use in emergency.
 - (k) Air-blowers should be used for flow of fresh air through the manholes. Whenever called for, portable air blowers are recommended for ventilating the manholes. The Motors for these shall be vapour proof and of totally enclosed type. Non sparking gas engines also could be used but they should be placed at least 2 metres away from the opening and on the leeward side protected from wind so that they will not be a source of friction on any inflammable gas that might be present.
 - (l) The workers engaged for cleaning the manholes/sewers should be properly trained before allowing to work in the manhole.
 - (m) The workers shall be provided with Gumboots or non sparking shoes bump helmets and gloves non sparking tools safety lights and gas masks and portable air blowers (when necessary). They must be supplied with barrier cream for anointing the limbs before working inside the sewer lines.
 - (n) Workmen descending a manhole shall try each ladder stop or rung carefully before putting his full weight on it to guard against insecure fastening due to corrosion of the rung fixed to manhole well.
 - (o) If a man has received a physical injury, he should be brought out of the sewer immediately and adequate medical aid should be provided to him.
 - (p) The extent to which these precautions are to be taken depend on individual situation but the decision of the Engineer-in-Charge regarding the steps to be taken in this regard in an individual case will be final.

The Contractor shall not employ men and women below the age of 18 years on the work of painting with products containing lead in any form. Wherever men above the age of 18 are employed on the work of lead painting, the following precaution should be taken:-

- (a) No paint containing lead or lead products shall be used except in the form of paste or readymade paint.
 - (b) Suitable face masks should be supplied for use by the workers when paint is applied in the form of spray or a surface having lead paint is dry rubbed and scrapped.
 - (c) Overalls shall be supplied by the contractors to the workmen and adequate facilities shall be provided to enable the working painters to wash during and on the cessation of work.
9. The Contractor shall not employ women and men below the age of 18 on the work of painting with product containing lead in any form, wherever men above the age of 18 are employed on the work of lead painting, the following principles must be observed for such use :
- (i) White lead, sulphate of lead or product containing these pigment, shall not be used in painting operation except in the form of pastes or paint ready for use.
 - (ii) Measures shall be taken, wherever required in order to prevent danger arising from the application of a paint in the form of spray.
 - (iii) Measures shall be taken, wherever practicable, to prevent danger arising out of from dust caused by dry rubbing down and scraping.
 - (iv) Adequate facilities shall be provided to enable working painters to wash during and on cessation of work.
 - (v) Overall shall be worn by working painters during the whole of working period.

- (vi) Suitable arrangement shall be made to prevent clothing put off during working hours being spoiled by painting materials.
 - (vii) Cases of lead poisoning and suspected lead poisoning shall be notified and shall be subsequently verified by medical man.
 - (viii) WAPCOS may require, when necessary medical examination of workers.
 - (ix) Instructions with regard to special hygienic precautions to be taken in the painting trade shall be distributed to working painters.
10. When the work is done near any place where there is risk of drowning, all necessary equipments should be provided and kept ready for use and all necessary steps taken for prompt rescue of any person in danger and adequate provision, should be made for prompt first aid treatment of all injuries likely to be obtained during the course of the work.
11. Use of hoisting machines and tackle including their attachments, anchorage and supports shall conform to the following standards or conditions :-
- (i) (a) These shall be of good mechanical construction, sound materials and adequate strength and free from patent defects and shall be kept repaired and in good working order.
 - (b) Every rope used in hoisting or lowering materials or as a means of suspension shall be of durable quality and adequate strength, and free from patent defects.
 - (ii) Every crane driver or hoisting appliance operator, shall be properly qualified and no person under the age of 21 years should be in charge of any hoisting machine including any scaffolding winch or give signals to operator.
 - (iii) In case of every hoisting machine and of every chain ring hook, shackle swivel and pulley block used in hoisting or as means of suspension, the safe working load shall be ascertained by adequate means. Every hoisting machine and all gear referred to above shall be plainly marked with the safe working load. In case of a hoisting machine having a variable safe working load each safe working load and the condition under which it is applicable shall be clearly indicated. No part of any machine or any gear referred to above in this paragraph shall be loaded beyond the safe working load except for the purpose of testing.
 - (iv) In case of departmental machines, the safe working load shall be notified by the Electrical Engineer-in-Charge. As regards contractor's machines the contractors shall notify the safe working load of the machine to the Engineer-in-Charge whenever he brings any machinery to site of work and get it verified by the Electrical Engineer concerned.
12. Motors, gearing, transmission, electric wiring and other dangerous parts of hoisting appliances should be provided with efficient safeguards. Hoisting appliances should be provided with such means as will reduce to the minimum the risk of accidental descent of the load. Adequate precautions should be taken to reduce to the minimum the risk of any part of a suspended load becoming accidentally displaced. When workers are employed on electrical installations which are already energized, insulating mats, wearing apparel, such as gloves, sleeves and boots as may be necessary should be provided. The worker should not wear any rings, watches and carry keys or other materials which are good conductors of electricity.
13. All scaffolds, ladders and other safety devices mentioned or described herein shall be maintained in safe condition and no scaffold, ladder or equipment shall be altered or removed while it is in use. Adequate washing facilities should be provided at or near places of work.
14. These safety provisions should be brought to the notice of all concerned by display on a notice board at a prominent place at work spot. The person responsible for compliance of the safety code shall be named therein by the contractor.

15. To ensure effective enforcement of the rules and regulations relating to safety precautions the arrangements made by the contractor shall be open to inspection by the Labour Officer or Engineer-in-Charge of the department or their representatives.
16. Notwithstanding the above clauses from (1) to (15), there is nothing in these to exempt the contractor from the operations of any other Act or Rule in force in the Republic of India.

ANNEXURE – XI

MODEL RULES FOR THE PROTECTION OF HEALTH AND SANITARY ARRANGEMENTS

FOR WORKERS EMPLOYED BY CONTRACTORS

1. APPLICATION

These rules shall apply to all buildings and construction works in which twenty or more workers are ordinarily employed or are proposed to be employed in any day during the period during which the contract work is in progress.

2. DEFINITION

Work place means a place where twenty or more workers are ordinarily employed in connection with construction work on any day during the period during which the contract work is in progress.

3. FIRST-AID FACILITIES

- (i) At every work place, there shall be provided and maintained, so as to be easily accessible during working hours, first-aid boxes at the rate of not less than one box for 150 contract labour or part thereof ordinarily employed.
- (ii) The first-aid box shall be distinctly marked with a red cross on white back ground and shall contain the following equipment:-
 - (a) For work places in which the number of contract labour employed does not exceed 50- Each first-aid box shall contain the following equipments :-
 - 1) 6 small sterilised dressings.
 - 2) 3 medium size sterilised dressings.
 - 3) 3 large size sterilised dressings.
 - 4) 3 large sterilised burn dressings.
 - 5) 1 (30 ml.) bottle containing a two per cent alcoholic solution of iodine.
 - 6) 1 (30 ml.) bottle containing salvolatile having the dose and mode of administration indicated on the label.
 - 7) 1 snakebite lancet.
 - 8) 1 (30 gms.) bottle of potassium permanganate crystals.
 - 9) 1 pair scissors.
 - 10) 1 copy of the first-aid leaflet issued by the Director General, Factory Advice Service and Labour Institutes, Government of India.
 - 11) 1 bottle containing 100 tablets (each of 5 gms.) of aspirin.
 - 12) Ointment for burns.
 - 13) A bottle of suitable surgical antiseptic solution
 - (b) For work places in which the number of contract labour exceed 50. Each first-aid box shall contain the following equipments.
 - 1) 12 small sterilised dressings.
 - 2) 6 medium size sterilised dressings.
 - 3) 6 large size sterilised dressings.
 - 4) 6 large size sterilised burn dressings.
 - 5) 6 (15 gms.) packets sterilised cotton wool.
 - 6) 6.1 (60 ml.) bottle containing a two per cent alcoholic solution iodine.
 - 7) 1 (60 ml.) bottle containing salvolatile having the dose and mode of administration indicated on the label
 - 8) 1 roll of adhesive plaster.
 - 9) 1 snake bite lancet.

- 10) 1 (30 gms.) bottle of potassium permanganate crystals.
 - 11) 1 pair scissors.
 - 12) 1 copy of the first-aid leaflet issued by the Director General Factory Advice Service and Labour Institutes / Government of India.
 - 13) A bottle containing 100 tablets (each of 5 gms.) of aspirin.
 - 14) Ointment for burns.
 - 15) A bottle of suitable surgical antiseptic solution.
- (iii) Adequate arrangements shall be made for immediate recoument of the equipment when necessary
 - (iv) Nothing except the prescribed contents shall be kept in the First-aid box.
 - (v) The first-aid box shall be kept in charge of a responsible person who shall always be readily available during the working hours of the work place.
 - (vi) A person in charge of the First-aid box shall be a person trained in First-aid treatment in the work places where the number of contract labour employed is 150 or more.
 - (vii) In work places where the number of contract labour employed is 500 or more and hospital facilities are not available within easy distance from the works. First-aid posts shall be established and run by a trained compounder. The compounder shall be on duty and shall be available at all hours when the workers are at work.
 - (viii) Where work places are situated in places which are not towns or cities, a suitable motor transport shall be kept readily available to carry injured person or person suddenly taken ill to the nearest hospital.

4. DRINKING WATER

- (i) In every work place, there shall be provided and maintained at suitable places, easily accessible to labour, a sufficient supply of cold water fit for drinking.
- (ii) Where drinking water is obtained from an Intermittent public water supply, each work place shall be provided with storage where such drinking water shall be stored.
- (iii) Every water supply or storage shall be at a distance of not less than 50 feet from any latrine drain or other source of pollution. Where water has to be drawn from an existing well which is within such proximity of latrine, drain or any other source of pollution, the well shall be properly chlorinated before water is drawn from it for drinking. All such wells shall be entirely closed in and be provided with a trap door which shall be dust and waterproof.
- (iv) A reliable pump shall be fitted to each covered well, the trap door shall be kept locked and opened only for cleaning or inspection which shall be done at least once a month.

5. WASHING FACILITIES

- (i) In every work place adequate and suitable facilities for washing shall be provided and maintained for the use of contract labour employed therein.
- (ii) Separate and adequate cleaning facilities shall be provided for the use of male and female workers.
- (iii) Such facilities shall be conveniently accessible and shall be kept in clean and hygienic condition.

6. LATRINES AND URINALS

- (ii) Latrines shall be provided in every work place on the following scale namely :-
 - (a) Where female are employed, there shall be at least one latrine for every 25 females.
 - (b) Where males are employed, there shall be at least one latrine for every 25 males.
 Provided that, where the number of males or females exceeds 100, it shall be sufficient if there is one latrine for 25 males or females as the case may be upto the first 100, and one for every 50 thereafter.

- (iii) Every latrine shall be under cover and so partitioned off as to secure privacy, and shall have a proper door and fastenings.
- (iv) Construction of latrines: The inside walls shall be constructed of masonry or some suitable heat-resisting nonabsorbent materials and shall be cement washed inside and outside at least once a year, Latrines shall not be of a standard lower than borehole system.
- (v) (a) Where workers of both sexes are employed, there shall be displayed outside each block of latrine and urinal, a notice in the language understood by the majority of the workers "For Men only" or "For Women Only" as the case may be.
(b) The notice shall also bear the figure of a man or of a woman, as the case may be.
- (vi) There shall be at least one urinal for male workers upto 50 and one for female workers upto fifty employed at a time, provided that where the number of male or female workmen, as the case may be exceeds 500, it shall be sufficient if there is one urinal for every 50 males or females upto the first 500 and one for every 100 or part thereafter.
- (vii) (a) The latrines and urinals shall be adequately lighted and shall be maintained in a clean and sanitary condition at all times.
(b) Latrines and urinals other than those connected with a flush sewage system shall comply with the requirements of the Public Health Authorities.
- (viii) Water shall be provided by means of tap or otherwise so as to be conveniently accessible in or near the latrines and urinals.
- (ix) Disposal of excreta: - Unless otherwise arranged for by the local sanitary authority, arrangements for proper disposal of excreta by incineration at the work place shall be made by means of a suitable incinerator. Alternately excreta may be disposed of by putting a layer of night soil at the bottom of a pucca tank prepared for the purpose and covering it with a 15 cm. layer of waste or refuse and then covering it with a layer of earth for a fortnight (when it will turn to manure).
- (x) The contractor shall at his own expense, carry out all instructions issued to him by the Engineer-in-Charge to effect proper disposal of night soil and other conservancy work in respect of the contractor's workmen or employees on the site. The contractor shall be responsible for payment of any charges which may be levied by Municipal or Cantonment Authority for execution of such on his behalf.

7. PROVISION OF SHELTER DURING REST

At every place there shall be provided, free of cost, four suitable sheds, two for meals and the other two for rest separately for the use of men and women labour. The height of each shelter shall not be less than 3 metres (10 ft.) from the floor level to the lowest part of the roof. These shall be kept clean and the space provided shall be on the basis of 0.6 sqm (6 sft) per head. Provided that the Engineer-in-Charge may permit subject to his satisfaction, a portion of the building under construction or other alternative accommodation to be used for the purpose.

8. CRECHES

- (i) At every work place, at which 20 or more women worker are ordinarily employed, there shall be provided two rooms of reasonable dimensions for the use of their children under the age of six years. One room shall be used as a play room for the children and the other as their bedroom. The rooms shall be constructed with specifications as per clause 19H (ii) a,b & c.
- (ii) The rooms shall be provided with suitable and sufficient openings for light and ventilation. There shall be adequate provision of sweepers to keep the places clean.
- (iii) The contractor shall supply adequate number of toys and games in the play room and sufficient number of cots and beddings in the bed room.
- (iv) The contractor shall provide one ayya to look after the children in the creche when the number of women workers does not exceed 50 and two when the number of women workers exceed 50.
- (v) The use of the rooms earmarked as creches shall be restricted to children, their attendants and mothers of the children.

9. CANTEENS

- a. In every work place where the work regarding the employment of contract labour is likely to continue for six months and where in contract labour numbering one hundred or more are ordinarily employed, an adequate canteen shall be provided by the contractor for the use of such contract labour.
- b. The canteen shall be maintained by the contractor in an efficient manner.
- c. The canteen shall consist of at least a dining hall, kitchen, storeroom, pantry and washing places separately for workers and utensils.
- d. The canteen shall be sufficiently lighted at all times when any person has access to it.
- e. The floor shall be made of smooth and impervious materials and inside walls shall be limewashed or colour washed at least once in each year.
Provided that the inside walls of the kitchen shall be lime-washed every four months.
- f. The premises of the canteen shall be maintained in a clean and sanitary condition.
- g. Waste water shall be carried away in suitable covered drains and shall not be allowed to accumulate so as to cause a nuisance.
- h. Suitable arrangements shall be made for the collection and disposal of garbage.
- i. The dining hall shall accommodate at a time 30 per cent of the contract labour working at a time.
- j. The floor area of the dining hall, excluding the area occupied by the service counter and any furniture except tables and chairs shall not be less than one square metre (10 sft) per diner to be accommodated as prescribed in sub-Rule 9.
- k. (a) A portion of the dining hall and service counter shall be partitioned off and reserved for women workers in proportion to their number.
(b) Washing places for women shall be separate and screened to secure privacy.
- l. Sufficient tables stools, chair or benches shall be available for the number of diners to be accommodated as prescribed in sub-Rule 9.
- m. (a) 1. There shall be provided and maintained sufficient utensils crockery, furniture and any other equipments necessary for the efficient running of the canteen.
2. The furniture utensils and other equipment shall be maintained in a clean and hygienic condition.
(b) 1. Suitable clean clothes for the employees serving in the canteen shall be provided and maintained.
2. A service counter, if provided, shall have top of smooth and impervious material.
3. Suitable facilities including an adequate supply of hot water shall be provided for the cleaning of utensils and equipments.
- n. The food stuffs and other items to be served in the canteen shall be in conformity with the normal habits of the contract labour.
- o. The charges for food stuffs, beverages and any other items served in the canteen shall be based on 'No profit, No loss' and shall be conspicuously displayed in the canteen.
- p. In arriving at the price of foodstuffs, and other article served in the canteen, the following items shall not be taken into consideration as expenditure namely:-
 - (a) The rent of land and building.
 - (b) The depreciation and maintenance charges for the building and equipment provided for the canteen.
 - (c) The cost of purchase, repairs and replacement of equipment including furniture, crockery, cutlery and utensils.
 - (d) The water charges and other charges incurred for lighting and ventilation
 - (e) The interest and amounts spent on the provision and maintenance of equipment provided for the canteen.
- q. The accounts pertaining to the canteen shall be audited once every 12 months by registered accountants and auditors.

10. ANTI-MALARIAL PRECAUTIONS

The contractor shall at his own expense, conform to all anti-malarial instructions given to him by the Engineer-in-Charge including the filling up of any borrow pits which may have been dug by him.

11. The above rules shall be incorporated in the contracts and in notices inviting tenders and shall form an integral part of the contracts.

12. AMENDMENTS

Government may, from time to time, add to or amend these rules and issue directions - it may consider necessary for the purpose of removing any difficulty which may arise in the administration thereof.

ANNEXURE-XII

Contractor's Labour Regulations

1. GENERAL

These Labour regulations shall be followed by the Contractor.

2. DEFINITIONS

- (i) Workman means any person employed by contractor directly or indirectly through a subcontractor with or without the knowledge of the WAPCOS to do any skilled, semiskilled or unskilled manual, supervisory, technical or clerical work for hire or reward, whether the terms of employment are expressed or implied but does not include any person :-
- (a) Who is employed mainly in a managerial or administrative capacity : or
 - (b) Who, being employed in a supervisory capacity draws wages exceeding five hundred rupees per mensem or exercises either by the nature of the duties attached to the office or by reason of powers vested in him, functions mainly of managerial nature: or
 - (c) Who is an out worker, that is to say, person to whom any article or materials are given out by or on behalf of the Employer/ Principal Employers to be made up cleaned, washed, altered, ornamental finished, repaired adopted or otherwise processed for sale for the purpose of the trade or business of the Employer/ Principal Employers and the process is to be carried out either in the home of the out worker or in some other premises, not being premises under the control and management of the principal employer.
- (i) No person below the age of 14 years shall be employed to act as a workman.
 - (ii) Fair Wages means wages whether for time or piece work fixed and notified under the provisions of the Minimum Wages Act from time to time.
 - (iii) Contractors shall include every person who undertakes to produce a given result other than a mere supply of goods or articles of manufacture through contract labour or who supplies contract labour for any work and includes a subcontractor.
 - (iv) Wages shall have the same meaning as defined in the Payment of Wages Act.
3. (i) Normally working hours of an adult employee should not exceed 9 hours a day. The working day shall be so arranged that inclusive of interval for rest, if any, it shall not spread over more than 12 hours on any day.
- (ii) When an adult worker is made to work for more than 9 hours on any day or for more than 48 hours in any week, he shall be paid over time for the extra hours put in by him at double the ordinary rate of wages.
 - (iii) Every worker shall be given a weekly holiday normally on a Sunday, in accordance with the provisions of the Minimum Wages (Central) Rules 1960 as amended from time to time irrespective of whether such worker is governed by the Minimum Wages Act or not.
 - (iv) Where the minimum wages prescribed by the Government under the Minimum Wages Act are not inclusive of the wages for the weekly day of rest, the worker shall be entitled to rest day wages at the rate applicable to the next preceding day,
 - (iv) provided he has worked under the same contractor for a continuous period of not less than 6 days.

- (v) Where a contractor is permitted by the Engineer-in-Charge to allow a worker to work on a normal weekly holiday, he shall grant a substituted holiday to him for the whole day on one of the five days immediately before or after the normal weekly holiday and pay wages to such worker for the work performed on the normal weekly holiday at overtime rate.

4. DISPLAY OF NOTICE REGARDING WAGES ETC.

The contractor shall before he commences his work on contract, display and correctly maintain and continue to display and correctly maintain in a clear and legible condition in conspicuous places on the work, notices in English and in the local Indian languages spoken by the majority of the workers giving the minimum rates of wages fixed under Minimum Wages Act, the actual wages being paid, the hours of work for which such wage are earned, wages periods, dates of payments of wages and other relevant information as per Appendix 'III'.

5. PAYMENT OF WAGES

- (i) The contractor shall fix wage periods in respect of which wages shall be payable.
- (ii) No wage period shall exceed one month.
- (iii) The wages of every person employed as contract labour in an establishment or by a contractor where less than one thousand such persons are employed shall be paid before the expiry of seventh day and in other cases before the expiry of tenth day after the last day of the wage period in respect of which the wages are payable.
- (iv) Where the employment of any worker is terminated by or on behalf of the contractor the wages earned by him shall be paid before the expiry of the second working day from the date on which his employment is terminated.
- (v) All payment of wages shall be made on a working day at the work premises and during the working time and on a date notified in advance and in case the work is completed before the expiry of the wage period, final payment shall be made within 48 hours of the last working day.
- (vi) Wages due to every worker shall be paid to him direct by contractor through Bank or ECS or online transfer to his bank account.
- (vii) All wages shall be paid through Bank or ECS or online transfer.
- (viii) Wages shall be paid without any deductions of any kind except those specified by the Central Government by general or special order in this behalf or permissible under the Payment of Wages Act 1956.
- (ix) A notice showing the wages period and the place and time of disbursement of wages shall be displayed at the place of work and a copy sent by the contractor to the Engineer-in-Charge under acknowledgment.
- (x) It shall be the duty of the contractor to ensure the disbursement of wages through bank account of labour.
- (xi) The contractor shall obtain from the Junior Engineer or any other authorised representative of the Engineer- in-Charge as the case may be, a certificate under his signature at the end of the entries in the "Register of Wages" or the "Wage-cum-Muster Roll" as the case may be in the following form:-

6. FINES AND DEDUCTIONS WHICH MAY BE MADE FROM WAGES

- i) The wages of a worker shall be paid to him without any deduction of any kind except the following:-
 - a. Fines
 - b. Deductions for absence from duty i.e. from the place or the places where by the terms of his employment he is required to work. The amount of deduction shall be in proportion to the period for which he was absent.

- c. Deduction for damage to or loss of goods expressly entrusted to the employed person for custody or for loss of money or any other deduction which he is required to account, where such damage or loss is directly attributable to his neglect or default.
 - d. Deduction for recovery of advances or for adjustment of overpayment of wages, advances granted shall be entered in a register.
 - e. Any other deduction which the Central Government may from time to time allow.
- ii) No fines should be imposed on any worker save in respect of such acts and omissions on his part as have been approved of by the Chief Labour Commissioner.
Note :- An approved list of Acts and Omissions for which fines can be imposed is enclosed at Appendix-X
 - iii) No fine shall be imposed on a worker and no deduction for damage or loss shall be made from his wages until the worker has been given an opportunity of showing cause against such fines or deductions.
 - iv) The total amount of fine which may be imposed in any one wage period on a worker shall not exceed an amount equal to three paise in a rupee of the total wages, payable to him in respect of that wage period.
 - v) No fine imposed on any worker shall be recovered from him by instalment, or after the expiry of sixty days from the date on which it was imposed.
 - vi) Every fine shall be deemed to have been imposed on the day of the act or omission in respect of which it was imposed.

7. LABOUR RECORDS

- i) The contractor shall maintain a Register of persons employed on work on contract in Form XIII of the CL (R&A) Central Rules 1971 (Appendix IV)
- ii) The contractor shall maintain a Muster Roll register in respect of all workmen employed by him on the work under Contract in Form XVI of the CL (R&A) Rules 1971 (Appendix V).
- iii) The contractor shall maintain a Wage Register in respect of all workmen employed by him on the work under contract in Form XVII of the CL (R&A) Rules 1971 (Appendix VI).
- iv) Register of accident - The contractor shall maintain a register of accidents in such form as may be convenient at the work place but the same shall include the following particulars:
 - a. Full particulars of the labourers who met with accident.
 - b. Rate of Wages.
 - c. Sex
 - d. Age
 - e. Nature of accident and cause of accident.
 - f. Time and date of accident.
 - g. Date and time when admitted in Hospital,
 - h. Date of discharge from the Hospital.
 - i. Period of treatment and result of treatment.
 - j. Percentage of loss of earning capacity and disability as assessed by Medical Officer.
 - k. Claim required to be paid under Workmen's Compensation Act.
 - l. Date of payment of compensation.
 - m. Amount paid with details of the person to whom the same was paid.
 - n. Authority by whom the compensation was assessed.
 - o. Remarks
- v) The contractor shall maintain a Register of Fines in the Form XII of the CL (R&A) Rules 1971 (Appendix-XI) The contractor shall display in a good condition and in a conspicuous place of work the approved list of acts and omissions for which fines can be imposed (Appendix-X)

- vi) The contractor shall maintain a Register of deductions for damage or loss in Form XX of the CL (R&A) Rules 1971 (Appendix-XII)
- vii) The contractor shall maintain a Register of Advances in Form XXIII of the CL (R&A) Rules 1971 (Appendix-XIII)
- viii) The contractor shall maintain a Register of Overtime in Form XXIII of the CL (R&A) Rules 1971 (Appendix-XIV)

8. ATTENDANCE CARD-CUM-WAGE SLIP

- i) The contractor shall issue an Attendance card-cum-wage slip to each workman employed by him in the specimen form at (Appendix-VII)
- ii) The card shall be valid for each wage period.
- iii) The contractor shall mark the attendance of each workman on the card twice each day, once at the commencement of the day and again after the rest interval, before he actually starts work.
- iv) The card shall remain in possession of the worker during the wage period under reference.
- v) The contractor shall complete the wage slip portion on the reverse of the card at least a day prior to the disbursement of wages in respect of the wage period under reference.
- vi) The contractor shall obtain the signature or thumb impression of the worker on the wage slip at the time of disbursement of wages and retain the card with himself.

9. EMPLOYMENT CARD

The contractor shall issue an Employment Card in Form XIV of the CL (R&A) Central Rules 1971 to each worker within three days of the employment of the worker (Appendix-VIII).

10. SERVICE CERTIFICATE

On termination of employment for any reason whatsoever the contractor shall issue to the workman whose services have been terminated, a Service certificate in Form XV of the CL (R&A) Central Rules 1971 (Appendix-IX)

11. PRESERVATION OF LABOUR RECORDS

All records required to be maintained under Regulations Nos. 6 & 7 shall be preserved in original for a period of three years from the date of last entries made in them and shall be made available for inspection by the Engineer-in-Charge or Labour Officer or any other officers authorised by the Ministry of Urban Development in this behalf.

12. POWER OF LABOUR OFFICER TO MAKE INVESTIGATIONS OR ENQUIRY

The Labour Officer or any person authorised by Central Government on their behalf shall have power to make enquires with a view to ascertaining and enforcing due and proper observance of Fair Wage Clauses and the Provisions of these Regulations. He shall investigate into any complaint regarding the default made by the contractor or subcontractor in regard to such provision.

13. REPORT OF LABOUR OFFICER

The Labour Officer or other persons authorised as aforesaid shall submit a report of result of his investigation or enquiry to the Engineer-in-charge concerned indicating the extent, if any, to which the default has been committed with a note that necessary deductions from the contractor's bill be made and the wages and other dues be paid to the labourers concerned. In case an appeal is made by the contractor under Clause 13 of these regulations, actual payment to labourers will be made by the Engineer-in-charge after the Competent Authority of WAPCOS has given his decision on such appeal.

- (i) The Engineer-in-charge shall arrange payments to the labour concerned within 45 days from the receipt of the report form the Labour Officer as the case may be.

14. **APPEAL AGAINST THE DECISION OF LABOUR OFFICER**

Any person aggrieved by the decision and recommendations of the Labour Officer or other person so authorised may appeal against such decision to the Engineer-in-charge concerned within 30 days from the date of decision, forwarding simultaneously a copy of his appeal to the Engineer-in-charge concerned but subject to such appeal, the decision of the officer shall be final and binding upon the contractor.

15. **PROHIBITION REGARDING REPRESENTATION THROUGH LAWYER**

- (i) A workman shall be entitled to be represented in any investigation or enquiry under these regulations by:-
 - a. An officer of a registered trade union of which he is a member.
 - b. An officer of a federation of trade unions to which the trade union referred to in clause (a) is affiliated.
 - c. Where the employer is not a member of any registered trade union, by an officer of a registered trade union, connected with the industry in which the worker is employed or by any other workman employed in the industry in which the worker is employed.
- (ii) An employer shall be entitled to be represented in any investigation or enquiry under these regulations by :-
 - a. An officer of an association of employers of which he is a member.
 - b. An officer of a federation of associations of employers to which association referred to in clause (a) is affiliated.
 - c. Where the employers is not a member of any association of employers, by an officer of association of employer connected with the industry in which the employer is engaged or by any other employer, engaged in the industry in which the employer is engaged.
- (iii) No party shall be entitled to be represented by a legal practitioner in any investigation or enquiry under these regulations.

16. **INSPECTION OF BOOKS AND SLIPS**

The contractor shall allow inspection of all the prescribed labour records to any of his workers or to his agent at a convenient time and place after due notice is received or to the Labour Officer or any other person, authorised by the Central Government on his behalf.

17. **SUBMISSIONS OF RETURNS**

The contractor shall submit periodical returns as may be specified from time to time.

18. **AMENDMENTS**

The Central Government may from time to time add to or amend the regulations and on any question as to the application/Interpretation or effect of those regulations the decision of the Engineer-in-charge concerned shall be final.

NOTE: APPENDICES mentioned in above "Contractor's Labour Regulation" will be as per the General Conditions of Contract-2020 – Construction Works of CPWD.

SECTION – VII

GENERAL TECHNICAL SPECIFICATION

TECHNICAL SPECIFICATION OF WORKS

- 1.1. General**
- 1.2. Civil Works**
- 1.3. Plumbing Works**
- 1.4. Fire Fighting Works**
- 1.5. Electrical Works**

1. TECHNICAL SPECIFICATIONS OF WORKS

1.1. General

- 1.1.1. Unless otherwise specified, the Work will be executed strictly in accordance with the CPWD specification corrected up to date at the time of tenders, unless specified to contrary. The specifications to be generally followed will be the following specifications and codes:
- a) CPWD specification
 - b) BIS specification
 - c) National building code
 - d) Schedule of Quantities (SoQ) and Drawings
 - e) Particular specification as applicable for respective works specified herein.
- 1.1.2. Error or omission, if any in the nomenclature, rate or unit of the items or work shall be corrected as per DSR 2019.
- 1.1.3. Measurement of work shall be done as per CPWD specifications and BIS codes, as applicable.
- 1.1.4. Actual quantities of completed and accepted work shall only be paid.
- 1.1.5. Nothing extra will be paid to the contractor for any lead or lift unless otherwise specified for any material required directly or indirectly under the contract.
- 1.1.6. Nothing extra will be paid to the contractor for diverting water in the channels or streams if it becomes necessary for the execution and completion of the work.
- 1.1.7. The contractor shall be responsible and liable for proper and complete execution of the entire work and ensure coordination and completion of Civil, Electrical, Plumbing, Mechanical/ Fire Fighting works, etc.
- 1.1.8. Any rock extracted during excavation from site shall be recovered and the same shall be used in the random rubble masonry or for stone pitching as much as possible. However, any Royalty to be paid to the Government shall be paid by the contractor.
- 1.1.9. The percentage of contract rates for the various items, wherein Supply, Installation, Testing, Commissioning (i.e. SITC) are involved in the Schedule of Quantities, shall be payable against the following stage of work:

| Sl. No. | Stage of work | %age of Quoted Rate for Item |
|---------|--|------------------------------|
| a) | On initial inspection of materials (as applicable)and delivery at Site in good condition | 70% |
| b) | On completion of installation/ erection | 20% |
| c) | On completion of Testing and Commissioning, as applicable | 10% |

1.1.10. Material for installation

- a. The Contractor shall bring the various items & materials as per actual requirement at site at the time of execution of work. For any material brought prematurely at site without approval of Engineer-in-Charge, no payment shall be made for such material and the Employer shall not be responsible for its damage / deterioration. The make of material has been indicated in the tender document. The Engineer-in-charge shall reserve the right to instruct the contractor to remove the material which, in his opinion, is not as per specifications.
- b. Quality of material: All materials and equipment for installation / work supplied by the Contractor shall be new. They shall be of such design, size and materials as to satisfactorily function under the rated conditions of operation and to withstand the environmental conditions at site.
- c. The quantities of various items may vary from the quantities given in schedule of Quantity (SoQ)/ Bill of Quantity (BoQ). The Contractor shall bring the various items & materials as per actual requirement at site. Excess material more than the actual requirement shall not be accepted & paid by the Employer.
- d. Before start of the work the Contractor is required to submit the shop drawings. The shop drawings shall be approved by the Engineer-in-Charge.
- e. Before placing orders on the manufacturer for supply of cables, pole, fittings, pipes, etc. the contractor is required to get assessed the exact requirement of each size of the cable at site of work and get the same approved from the Engineer-in-charge. The Employer shall not take back any spare quantity of cable whether in pieces or in sealed drums/ containers, if procured more than that required at site / approved by the Engineer-in-charge.

However, it may be noted that the contractor shall have to arrange extra quantity of the cables, poles, fittings, pipes, etc. over and above that assessed by the contractor, before start of the work and approved by the Engineer-in-charge, if such additional quantity of the cables, poles, fittings, pipes, etc., is required at site, in order to make the installation as covered in Scope of this work and in order to make the installation operational. Such quantity shall be paid as per contractual provisions of the Agreement.

1.1.11. Completeness of work

All hardware items such as screws, thimbles, G.I. wires, etc. which are essentially required for completing an SoQ item as per specifications will be deemed to be included in the item even when the same have not been specifically mentioned. All hardware materials such as nuts/bolts/screws/washers etc. to be used in the scheduled items shall be zinc/cadmium plated iron. Nothing extra on account of same shall be paid.

1.1.12. For items/equipment requiring initial inspection at manufacturer's works' the contractor will intimate the date of testing of equipment at the manufacturer's works before dispatch. The Employer also reserves the right to inspect the fabrication job at factory and the Contractor has to make the arrangement for the same. The Contractor shall give sufficient advance notice regarding the dates proposed for such tests/inspection to the Employer's representative(s) to facilitate his presence during testing/fabrication. The Engineer-in-charge at his discretion may waive off such testing/fabrication. The cost of the Engineer-in-charge's visit to the factory will be borne by the Contractor. Also, equipment may be inspected at the Manufacture's premises before dispatch to the site by the contractor.

1.1.13. Conformity with statutory Acts, Rules, Standards and Codes

- a. All components shall conform to relevant Indian Standard Specifications, International Standards and shall bear the stamp of the testing laboratory wherever existing and amended to date.
- b. In respect of all labor employed directly or indirectly on the work for the execution of the work, the contractor at his own expense, will arrange for the safety provisions as per the statutory provision, BIS recommendations, factory act, and workman's compensation act, CPWD code and instructions issued from time to time. Failure to provide such safety requirements would make the Contractor liable for penalty. In addition, the Engineer-in- Charge, shall be at liberty to make arrangements and provide facilities as aforesaid and recover the cost incurred thereon from the Contractor.
- c. The contractor shall provide necessary barriers, signals and other safety measures wherever necessary so as to avoid accident. He shall also indemnify the Employer against claims for compensation arising out of negligence in this respect. Contractor shall be liable, in accordance with the Indian law and Regulations for any accident occurring due to any cause. The Employer shall not be responsible for any accident occurred or damage incurred or claims arising their form during the execution of work, the Contractor shall cover the risk. No extra payment would be made to the contractor due to the above provisions thereof.

1.1.14. Care of the Building

Care shall be taken by the contractor while handling and installing the various equipment and components of the work to avoid damage to the building. He shall be responsible for repairing all damages and restoring the same to their original finish at his cost. He shall also remove at his cost all unwanted and waste materials arising out for the installation from the site of work.

1.1.15. Performance Guarantee for Equipment Installation including Electrical works

The Contractor shall guarantee among other things, the following:

- a) Quality, Strength and performance of the materials used.
- b) Safe mechanical and electrical stress on all parts under all specified conditions of operation.
- c) Satisfactory operation during the maintenance period.

1.1.16. Guarantee of Equipment Installation

All equipment/ installations shall be guaranteed for a period of 1 years from the date of taking over the installation by the Employer or for the period of the manufacturer's guarantee period whichever is greater against unsatisfactory performance and/or break down due to defective design, workmanship of material. The equipment or components, or any part thereof, so found defective during guarantee period shall be forthwith repaired or replaced free of cost, to the satisfaction of the Engineer-in-Charge.

In case it is felt by the Employer that undue delay is being caused by the contractor in doing this, the same will be got done by the Employer at the risk and cost of the contractor. The decision of the Engineer-in-Charge in this regard shall be final.

1.1.17. Training, Operation & Maintenance

Training of Owner's staff for operation and maintenance of all equipment such as Transformer, CCTV system, all electrical Panels/Equipment's and any other equipment shall be arranged by Contractor. In addition to this, the Contractor shall be required to hand over all installed equipment's manuals to the Owner.

1.1.18. The entire installation shall be at the risk and responsibility of the contractor until these are tested and handed over to the Employer. However, if there is any delay in construction from the Employer side, the installation may be taken over in parts, but the decision on the same shall rest with Engineer-in Charge which shall be a binding on the contractor.

1.1.19. Power Supply

Electrical power/Alternate source including backup power supply (as and when required) shall be arranged by the contractor for Construction, installation purpose at his own cost and payment for electricity charges shall be made by contractor. Electrical power supply required for testing of entire

installation after completion shall be arranged by the Employer/Owner.

1.1.20. Data Manual and Drawings to be furnished by the Contractor

The Contractor would be required to submit the followings for approval before commencement of installation.

- a. Technical submittal/ catalogue/ brochures of all equipment's installations to Engineering -In-Charge. Only after approval of such approval, the Contractor should place order for equipment and bring it to site.
- b. Any other drawing/information not specifically/mentioned above but deemed to be necessary for the job by the contractor.

1.1.21. Completion Plan & Test Certificate for Equipment Installations including Electrical

The layout of all the installation for all services with proper dimensions, shall be finalized in consultation with the Engineer-in-Charge or his representative and the layout shall be got approved by the Engineer-in-Charge before start of the work.

Contractor shall submit completion plan/ Electrical drawings in triplicate before finalisation of bill.

1.1.22. Verification of correctness of Equipment at Destination:

The materials shall be procured only from the manufacturers and their authorized dealers and documentary proof for such procurement and supply shall be produced by the contractor as required by Engineer-in-charge. The contractor shall have to produce all the relevant records to certify that the genuine equipment from the manufacturers has been supplied and erected. The Employer reserves the right to send such materials to the manufacturers / authorized test laboratory to verify the genuineness and quality of the product. The Contractor shall submit all documentary details in fulfillment of this of invoices, test certificates; gate passes etc. to prove the genuineness of material/purchases from manufacturer or authorized dealers which are used at site as per agreement.

1.1.23. Painting:

All equipment works shall be painted at the workshops/factory/manufacturing unit before dispatch to the site. Care shall be taken by the contractor while handling and installing the various equipment and components of the work to avoid damage to the finishes of equipment. He shall be responsible for repairing all damages and restoring the same to their original finish at his cost. He shall also remove at his cost all unwanted and waste materials arising out for the installation from the site of work.

1.1.24. Maintenance during defect liability period

Sufficient trained and experienced staff shall be made available to meet any exigency of work attends

the complaint during the defect liability period from the handing over of the project.

1.1.25. The contractor shall ensure that all the skilled persons managed / deployed for executing the electrical work possess wireman license issued by approved authorities, otherwise he will not be permitted to execute the work. Also, consequences arising due to the default of the contractor to comply with this condition would be contractor's responsibility only.

1.2. CIVIL WORKS

1.2.1 Technical specification for Hostel, Warden residence and Principal quarter are listed below:

| S.No. | ITEM NAME | HOSTEL DORMITORY | WARDEN RESIDENCE /TYPE III & TYPE II QUARTERS | PRINCIPAL QUARTER & GUEST HOUSE |
|-------|-----------------------------------|---|---|---------------------------------|
| 1 | Foundation & Structure | As per structural requirements based on soil investigation report. The design shall vary as per soil conditions. | | |
| 2 | Superstructure | | | |
| a) | Structure | RCC framed & Filler walls of Aerated Cement Concrete (ACC) / Cellular Concrete Block (CLC)/ Clay Brick work/Fly-ash brick | | |
| b) | Internal Partition | Half brick thick masonry in ACC/CLC/ Fly ash Brick | | |
| c) | Clear Ceiling height | 3.15 M | 3.00 Mt | |
| d) | Plinth Height | Plinth height of buildings shall be kept as 60cm from the adjoining ground level/ plinth protection level. Where plinth height becomes more than 60 cm special care shall be taken. If plinth height more than 1.20 mtrs., approval of the competent authority may be sought. | | |
| 3 | Door & Window Frame | | | |
| a | Frame | | | |
| | Door Frame | Providing and fixing T-iron frames of 40*40*6 mm with 15*3 mm lugs 10 cm long embedded in cement concrete block 15*10*10 cm of C.C. 1:3:6 (As per D.S.R.-2019 item no. 10.13.1) | | |
| | Window Frame & Ventilators | Providing and fixing factory-made ISI marked steel glazed window (partly fixed and/or partly side hung/top hung) and side hung wire gauzed windows shutters with Z- section, window grills fixing with 15x3 mm lugs 10 cm long embedded in cement concrete block 15*10*10cm of CC. 1:3:6(As per D.S.R.-2019 item no. 10.11.1) | | |
| b | Shutters | | | |

| | | | | |
|----------|---|---|---|--|
| | Main Doors | <p>i) Powder coated Aluminum Glazed Doors with fixed glazing on either side.</p> <p>ii) M.S. collapsible steel shutters (for safety measure) to main entrance lounge at GF.</p> | <p>(i) Factory made Machine pressed pre-laminated flush door exterior grade with teak wood lipping on edges. The lamination sheet used shall be decorative high pressure of plain / wood grain in gloss / matt/ suede finish with high density protective surface layer and reverse side of adhesive bonding quality conforming to IS: 2046 Type S. The door shall be fixed to T Iron frame with SS Hinges.</p> <p>(ii) Safety door MS tubular boxsection styles and rails frame i/c Stainless steel Mosquito Proof Jali.</p> | |
| | Other Doors | <p>Single shutters with 35 mm thick factory-made exterior grade Non- Decorative typeflush door shutter with teak wood lipping on edges & finished with one coat of wood primer followed by two or more coat of synthetic enamel paints. (As per D.S.R.- item no. 9.21.1 & 9.23 for flushdoor)</p> | | |
| | Bath. WC. Toilets Doors | <p>Factory made Machine pressed pre-laminated flush door exterior grade with teakwood lipping on edges.</p> <p>The lamination sheet used shall be decorative high pressure of plain / wood grain in gloss / matt/ suede finish with high density protective surface layer and reverse side of adhesive bonding quality conforming to IS: 2046 Type S. The door shall be fixed to T Iron frame with SS Hinges.</p> | | |
| | Windows & Ventilators | <p>Z- Section Double shutter one with frosted glass panes and other with stainlesssteel wire mesh shutter.</p> <p>All windows and ventilator shall be provided with 12 mm square guard bars at 10 to 12 cms. C/C spacing</p> | | |
| | Hardware & Fittings | <p>Powder coated/anodized Aluminum/ SS fittings</p> | | |
| 4 | FLOORING | | | |
| a) | Living/Drawing Room. Bed Rooms. Dining & Family Lounge with matching grouting of joints | <p>All flooring Kota stone combination with marble strip except WC/toilets area with matching grouting of joints</p> | <p>600 mm x 600 mm Vitrified Tile Flooring laid on 20mm thick cement mortar 1:4 (1 cement: 4 coarse sand) jointing with grey cement slurry @ 3.3 kg/sqm including grouting the joints with white cement and matching pigments etc., complete.</p> | <p>600 mm x 600 mm Vitrified Tile Flooring laid on 20mm thick cement mortar 1:4 (1 cement: 4 coarse sand) jointing with grey cement slurry @3.3 kg/sqm including grouting the joints with white cement and matching pigments etc., complete.</p> |

| | | | | |
|----------|------------------------------------|--|---|---|
| b) | Kitchen | | Anti-skid Ceramic/ vitrified tiles of size not less than 300 mm* 300 mm with water absorption less than 0.08% laid with 20mm thick cement mortar 1:4 (1 cement: 4 coarse sand) jointing with grey cement slurry 3.3kg/sqm including grouting the joints with white cement and matching pigments etc., Complete. | Anti-skid vitrified tiles of size not less than 300 mm * 300 mm with water absorption less than 0.08% laid with 20mm thick cement mortar 1:4 (1 cement: 4 coarse sand) jointing with grey cement slurry @ 3.3kg/sqm including grouting the joints with white cement and matching pigments etc., Complete. |
| c) | Common circulation area | Kota stone slab flooring with marble strips (up to 50mm width) in required pattern including rubbing and polishing complete | | |
| d) | Staircase | Kota stone in single length up to 1.05 meter of treads & risers | | |
| e) | Toilets / Bathroom | Glazed ceramic anti-skid of size not less than 300*300 mm with matching grouting of joints | | |
| f) | Skirting in rooms and other areas. | 100 to 150 mm height skirting matching with floor materials | | |
| g) | Kitchen Platform/ Dado | NA | (i) Platform- Granite Stone (ii) Dado over kitchen platform-1st Quality Ceramic Glazed wall tiles of approved sizes from 600 height from platform | (i) Platform- Granite (ii) Dado over kitchen platform- 1st Quality Ceramic Glazed wall tiles of approved sizes from 600 height from platform |
| h) | Toilets/bathrooms/ WC Dado | 1st quality ceramic glazed wall tiles of size not less than 200mm * 300mm inside WC Area upto 900mm height & for remaining area of toilet block shall be upto 2100mm height. | 1st quality ceramic glazed wall tiles of size not less than 200mm * 300mm inside WC area upto 900mm height & for remaining area of toilet block shall be upto 2100mm height. | 1st quality ceramic glazed wall tiles of size not less than 200mm * 300mm inside WC area up to 900mm height & for remaining area of toilet block shall be upto 2100mm Height |
| 5 | FINISHES | | | |

| | | | | |
|----|--|---|--|---|
| a) | Internal Walls | (i) All walls to be painted with low VOC Acrylic washable distemper. (ii) Synthetic enamel paint on all woodworks and steel works | (i) All walls to be painted with low VOC Acrylic washable distemper. (ii) Synthetic enamel paint on all woodworks and steel works. | (i) All walls to be painted with low VOC Acrylic washable distemper. (ii) Synthetic enamel paint on all woodworks and steel works |
| b) | External Walls | Synthetic enamel paint on all wood work & steel work. Premium Acrylic Smooth exterior paint with Silicone additives or its equivalent | | |
| c) | Hand Rail | Stair Case Railing -SS | Stair Case Railing -MS | NA |
| d) | Roof | RCC Slab brick with Coba treatment (Item No. 22.7.1 of DSR-19) | | |
| e) | Toilets for Physically disabled person | One each for boys and girls (specification as per NBC) | NA | NA |
| f) | Overhead Water Tank (OHT) | As per drawings | As per drawings | As per drawings |

1.2.2 Technical Specification for School building, Kitchen and Dining are listed below:

| S.No. | ITEM NAME | SCHOL BUILDING | KITCHEN & DINNING |
|-------|-----------------------------------|---|-------------------|
| | | | |
| 1 | Foundation & Structure | As per structural requirements based on soil investigation report. The design shall vary as per soil conditions. | |
| 2 | Superstructure | | |
| a) | Structure | RCC framed & Filler walls of Aerated Cement Concrete (ACC) / Cellular Concrete Block (CLC)/ Clay Brick work/Fly-ash brick | |
| b) | Internal Partition | Half brick thick masonry in ACC/CLC/Fly-ash Brick | |

| | | | |
|----------|--------------------------------|---|---|
| c) | Clear Ceiling height | 3.60M | 3.45M |
| d) | Plinth Height | Plinth height of buildings shall be kept as 60 cm from the adjoining ground level/plinth protection level. Where plinth height becomes more than 60 cm special care shall be taken. If plinth height more than 1.20 mtr., approval of the competent authority may be sought. | |
| 3 | Door & Window Frame | | |
| a | Frame | | |
| | Door Frame | Providing and fixing T-iron frames of 40*40*6 mm with 15*3 mm lugs 10cm long embedded in cement concrete block 15*10*10 cm of C.C. 1:3:6 (As per D.S.R.-2019 item no. 10.13.1) | |
| | Window Frame & Ventilators | Providing and fixing factory-made ISI marked steel glazed windows (partly fixed and/or partly side hung/top hung) with z- section, window grills fixing with 15x3 mm lugs 10cm long embedded in cement concrete block 15x10x10 cm of C.C. 1:3:6 (As per D.S.R.-2019 item no. 10.11.1) | Providing and fixing factory-made ISI marked steel glazed windows (partly fixed and/or partly side hung/top hung) and side hung wire gauzed windows shutter with z-section, window grills fixing with 15x3 mm lugs 10 cm long embedded in cement concrete block 15x10x10 cm of C.C. 1:3:6 (As per D.S.R.-2019 item no. 10.11.1) |
| b | Shutters | | |
| | Main Doors | i) Powder coated Aluminum Glazed Doors with fixed glazing on either side and on the top below floor beams. ii) M.S. collapsible steel shutters (for safety measure) to main entrance (for safety measure only) | (i) Powder coated Aluminum Glazed Doors with fixed glazing on either side and on the top below floor beam (ii) M.S. collapsible steel shutters at main entrance (for safety measure) only |
| | Other Doors | Single shutters with 35 mm thick factory-made exterior grade Non-Decorative type flush door shutter with teakwood lipping on edges & finished with one coat of wood primer followed by two or more coat of synthetic enamel paints. (As per D.S.R.- item no. 9.21.1 & 9.23 for flush door) | |

| | | | |
|----------|---|---|--|
| | Bath. WC. Toilets Doors | Factory made Machine pressed pre-laminated flush door exterior grade with teak wood lipping on edges. The lamination sheet used shall be decorative high pressure of plain / wood grain in gloss / matt/ suede finish with high density protective surface layer and reverse side of adhesive bonding quality conforming to IS: 2046 Type S. The door shall be fixed to T Iron frame with SS Hinges. | |
| | All Window/ ventilator Grills (except WC, Toilets, Baths) | Z-section single shutter with plain glass panes, windows and ventilator shall be provided with 12 mm square guard bars at 10 to 12 cm. C/C spacing. | Z- Section Double shutter one with frosted glass panes and other with stainless steel wire mesh shutter. All windows and ventilator shall be provided with 12 mm square guard bars at 10 to 12 cm. C/C spacing |
| | Windows/ ventilators Frame | Z-section single shutter with Frosted Glass | |
| | Hardware & Fittings | Powder coated/anodized Aluminum/ SS fittings | |
| 4 | FLOORING | | |
| a) | Main entrance hall, common circulation area | Mirror polished Kota stone with marble strip | |
| b) | Other | Classroom - (Kota stone slab flooring with marble strips (up to 50mm width) in required pattern including rubbing and polishing complete) | Dining Hall & Kitchen Area - (Kota stone slab flooring with marble strips (up to 50mm width) in required pattern including rubbing and polishing complete) |
| c) | Staircase/steps | Kota stone in single length up to 1.05 meter of treads & risers | |
| d) | Toilets / Bathroom | Glazed ceramic anti-skid of size not less than 300*300 mm with matching grouting of joints | |
| e) | Skirting in rooms and other areas. | 100 to 150 mm height skirting matching with floor materials | |
| f) | (i) In toilets/WCs /Baths (including common circulation area of toilet block) | Glazed ceramic anti-skid of size not less than 300x300 mm with matching grouting of joints. | Glazed ceramic anti-skid of size not less than 300x300 mm with matching grouting of joints. |

| | | | |
|----------|--|---|--|
| g) | Dado | | |
| i | In Toilets / WCs / Baths (including common circulation area of toilet block) | 1 st Quality Ceramic Glazed wall tiles of approved sizes from floor up to 900 mm height in toilet and remaining area of toilet block up to 2100mm height. | 1 st Quality Ceramic Glazed wall tiles of approved sizes from floor upto 2.1 meter height except in WC, which shall be 900mm dado |
| ii | Counter/Pantry/Dining | At Laboratory platform: Granite stone with nosing | Kota stone for kitchen and pantry platform. |
| h) | Kitchen/Pantry | NA | 1st Quality Ceramic Glazed wall tiles of approved sizes from floor up to 2.1-meter height |
| i) | Dining Area | NA | 1st Quality Ceramic Glazed wall tiles of approved sizes from floor up to 1.20-meter height |
| j) | Open Court Yard | Flag hoisting/Central court yard of school building. (i) Top Course: 60 mm thick thick factory made cement concrete interlocking paver block of M-30 grade made by block making machine with strong vibratory compaction etc., in required colour, pattern.50mm thick compacted bed of course sand etc., (as per item no.16.68,DSR -19) (ii) Based course : 7.50 cm thick CC (1:5:10) (iii) The top level of Court yard shall be 15 cm from formation level of School Building. | Kitchen back courtyard with Kota Stone slab flooring and front Dining courtyard with anti-skid vitrified tile 300 x 300 mm flooring |
| 5 | ROOFING | | Kitchen back side courtyard and Dinning Front Courtyard : Precoated GI profile sheet roofing |
| 6 | FINISHING | | |

| | | | |
|----|--|--|--|
| a) | Internal Walls | (i) All walls and ceilings to be painted with low VOC Acrylic washable distemper. (ii) Synthetic enamel paint on all woodworks and steel works | (i) All walls and ceilings to be painted with low VOC Acrylic washable distemper. (ii) Synthetic enamel paint on all wood works and steel works |
| b) | External Walls | Synthetic enamel paint on all wood work & steel work. Premium Acrylic Smooth exterior paint with Silicone additives or its equivalent 1 mm thick cement-based putty on external face leaving CC tile cladding area. | Synthetic enamel paint on all wood work & steel work. Premium Acrylic Smooth exterior paint with Silicone additives or its equivalent |
| 7 | Railing | Staircase & Ramp Railing -SS 304 Grade (ii) Corridor in between Columns - 1350 mm height MS grill/railing as per approved drawings | Staircase & Ramp Railing –SS Grade 304 |
| 8 | Roof Water Treatment | Brick Coba Treatment as per DSR-19, item No. 22.7.1 | Brick Coba Treatment as per DSR- 19, item No. 22.7.1. |
| 9 | Toilets for Physically disabled person | One each for boys and girls (Specification as per NBC) | N.A |
| 10 | Roof Water Tank | 8,000 Liters over each toilet block for general use and 10,000 Liters for Fire in one toilet block only / or As per drawing | 8000 Liters / or As per drawing |
| 11 | Cooking Platform | - | RCC as per design and drawings |
| 12 | Pantry | - | RCC as per design and drawings |
| 13 | Laboratories Counter/Platform | RCC as per design and drawings | NA |

| | | | |
|----|-------------------------------------|---|--|
| 14 | Ramp for Physically disabled person | One no. (specification as per NBC) | One no. (specification as per NBC) on each entrance |
| 15 | Staircase | Only Two Front Staircase shall run upto mumty. The back Staircase shall stop to FF Level. | MS Ladder shall be provided to reach the roof for maintenance purpose. |

1.2.3 Detail Scope and specifications of development works and campus boundary wall are listed below:

| S.NO. | NAME OF WORK | DETAILS |
|----------|--|---|
| 1 | Preparation of play fields: | |
| a) | Playfield for football, cricket, hockey etc. including running track: 1 no. (As per drawing) | Leveling with good earth after filling/cutting of earth. The quantities of earth filling/cutting shall be worked out in detailed calculation basis as per initial level, contour plan. Finished level shall be 15 cm higher than the adjoining ground level so that water logging can be avoided. |
| b) | Basket Ball fields - 2 nos. (As per Drawing) | (a) Leveling with good earth after filling/cutting of earth. The quantities of earth filling/cutting shall be worked out in detailed calculation basis as per initial level, contour plan. Finished level shall be 15 cm. higher than the adjoining ground level, so that, water logging can be avoided. b) CC court with pole, board, basket etc. (i) Base concreting CC 1:5:10) of 7.50 cm thick (ii) Top course Concreting (M-20 grade designed mix) of 10 cm thick. iii) Pole, board, Basket: As per SAI standard. |
| c) | Kho kho / Volley Ball court: 2 nos. (As per Drawing) | Leveling with good earth after filling/cutting of earth. The quantities of earth filling/cutting shall be worked out in detailed calculation basis as per initial level, contour plan. Finished level shall be 30 cm. higher than the adjoining ground level, so that, water logging can be avoided |
| d) | Archery court: 1 nos (4 Stands and Targets) (As per Drawing) | (a) Leveling with good earth after filling/cutting of earth. Preparation and consolidation of sub grade with power road roller with Brick edging in full brick width and half brick depth, |
| 2 | Internal roads, paths and culverts: | |

| | | |
|----------|--|--|
| a) | Internal roads (Cement Concrete roads): | (i) Width: Shall be 3.50 mtrs. + 1 mtrs. Shoulder/side berm of eachside. (ii) Road shall be constructed up to the all building units. i iii) BaseCourse CC (1:5:10) of 10 cm thick. (iv) Top Course (M-20 grade designed mix) of 15 cm thick, (v) Finished/top level of the edge of the roads i.e. shoulder level shall be 15 cm. higher than the adjoining ground level. |
| b) | Pathways: | (i) 2.00 mtrs. width + 1 mtrs. shoulder/side berm each side of the pathways. (ii) Pathways shall be provided to connect the buildings/ permanent infrastructure to nearby internal roads. (iii) No pathways shall be provided on side of the roads. (iv) Top Course: 60 mm thick factory-made cement concrete interlocking paver block of M-30 grade made by block making machine with strong vibratory compaction etc. in required colour, pattern, 50 mm thick compacted bed of course sand etc. (as per item no. 16.68, DSR-16) (v) Base course: 7.50 cm thick CC (1.5:10). (vi) Kerb stone on edge (50 mm thick, 250 mm height (for which shall be embedded underground): Factory Made kerb stone of M-25 grade cement concrete (as per item no. 16.69, DSR-16). (vii) Finished/top level of the edge of the paths shall be 15 cm. higher than the adjoining ground level. |
| c) | Culverts | As per actual requirement |
| 3 | External water supply | |
| a) | Tube/open well i/c 2 Nos. submersible pump 7.5 HP (preferably Solar Powered) & cabling etc. complete | Shall be executed as per availability of underground water after examination by the local PHED or any other elated Govt, agencies i.e. Central Ground Water Board, Local PHED etc. The yield of water source shall be 15000 LPH or more. |
| b) | Overhead Tank | Required in all building (As per Drawing) |
| c) | Under Ground Sump | 100000 ltr. Capacity with 2 nos. centrifugal pumps including one standby. |

| | | |
|----------|--|---|
| d) | Pump house | <ul style="list-style-type: none"> i. Size - As per drawing ii. Plinth area- As per drawing. iii. Floor height - As per drawing. iv. Building shall be RCC framed structure with slope roof and shall be executed over Under Ground Water Tank. v. Flooring -CC vi. Internal Painting- White Wash vii. Door- Laminated Machine Pressed Flush Door viii. Window - Steel Glazed Door |
| e) | Water filtration plant (if required) | Shall be executed if required, after conducting necessary water test through local PHED or any other related Govt, agencies. |
| f) | GI/CI water supply distribution line | G I Pipes for intake from bore well and supply to OH Tanks, maximum dia -100/80 mm nominal size. Distribution line shall be designed as per the intake of the buildings. All pipes shall be CPVC only. |
| 4 | External Electrification: | |
| a) | Substation building | <ul style="list-style-type: none"> (i) Plinth area- As per drawing. (ii) Floor height - As per drawing. (iii) Building shall be RCC framed structure with slop roof. (iv) Flooring -CC (v) Internal Painting- White Wash (v) Door- Laminated Machine Pressed Flush Door (vi) Window - Steel Glazed Door |
| b) | LT Panel | Fabricated from CPRI approved workshop |
| c) | External wiring/cable connection using U.G. cables from sub-station to feeder pillar, building & pump house and necessary connection from DG set to infrastructures. | 250KVA sub-station depending on the location of the School. However, capacity of sub-station may be confirmed after consultation with concern state electricity board. |
| 5 | External sewerage System | |
| a) | Septic Tank & Soak pit | <ul style="list-style-type: none"> (i) Proper planning shall be made before preparation of Preliminary estimate. (ii) Septic tank shall be designed as per the user and as per CPWD specification. (iii) Septic tank shall be RCC including walls as per IS dimension for 200v users for school, Girls Hostel and Boys' Hostel each (iv) Sufficient soak pit or dispersion channels shall be provided as per the soil condition |
| b) | External sewerage line (RCC NP2 pipe) | Proper planning shall be made before preparation of Preliminary estimate |

| | | |
|--|---|--|
| 6 | 7.5 H P. Sewerage Pump | Air Cool, mounted on trolley with 10m. Suction & 10m. del. Flexible pipe |
| 7 | 62.5 KVA DG Set | (i) Including erection, installation, testing, commissioning etc. (ii) Essential connection to various building shall be provided as per latest NVS guideline/ order. |
| 8 | Retaining wall / Breast wall (if required) | Proper planning shall be made before preparation of Preliminary estimate |
| 9 | Storm Water Drain | (i) Proper planning shall be made after examining the levels of the campus very carefully before preparation of Preliminary estimate. Rain water pipe collect from the buildings shall be connected with the campus storm water drain. (ii) Road side drain shall be avoided. (iii) Level of out fall drains of EMRS is always kept higher than the highest water level of Nallah/Natural drainage where water will be disposed off finally. |
| 10 | Rain water harvesting | Proper planning shall be made before preparation of Preliminary estimate |
| Campus Boundary Wall including Main Gate and Chowkidar Hut: | | |
| 1 | Campus Boundary wall | (i) Boundary wall – As per drawing (ii) Height of boundary wall including fencing details with concertina wire over the wall – As per the drawing (iii) The campus boundary wall shall be of RCC column, plinth beam, top band and filler wall in brick work. |
| 2 | Chowkidar Hut/Sentry Booth | (i) Plinth area- As per drawing. (ii) Floor height - As per drawing. (iii) Building shall be RCC framed structure with slope roof. (iv) Other specification as per Annexure-V of PAR-19 for Type-I qtrs. |
| 3 | Main Gate - Depending upon layout two gates, one for school and other for residential area may be provided. | (i) Width & Height of Main Gate: As per drawing. (ii) Wicket Gate: As per drawing. |

For all civil works, the work for all DSR items shall be executed strictly in accordance with the CPWD specifications corrected up to date at the time of tenders, unless specified to contrary. The specifications for the non-scheduled items are mentioned below.

1.2.1. Single Bucket Dustbin

Single bucket dustbin with minimum dry waste carrying capacity of 40kg weight and 70 L volume shall be fixed on stands, tiltable with open top and be made of 202 Grade Stainless Steel sheet of minimum thickness of 0.8mm and shall be corrosion resistant. Rates shall be inclusive of floor standing dustbin

assembly with all accessories, stands, fittings/fixtures and fixing in totality. The Design shall be approved from Engineer-in-charge. Other specification as per BOQ.

1.2.2. Flag Post

Supplying, installation and fixing Galvanized Iron high mast pole for National flags of height 6 meter. Pole shall be conical in shape of bottom & Top diameter- 20mm, Thickness - 1.0mm including holes and other accessories. Diameter of the base shall be 110mm and thickness of base plate shall be minimum 2mm. The rate shall be inclusive of National flag of required size as per IS code with hoisting arrangements and including mounted base, base plate and all other accessories. Other specification as per BOQ.

1.2.3. Brick Tile Cladding

Material

1st class burnt clay brick tile shall be used. It shall be hard, sound durable and tough free from cracks, decay and weathering and defects like cavities cracks, flaws, holes, veins, patches of soft or loose materials etc. Thickness of tile shall be as approved by architect or Engineer-in-Charge. Before starting the work, the contractor shall get the samples of brick tile approved by Engineer-In-charge. Approved sample shall be kept in custody of Engineer-in-Charge and tile supplied and used on the work shall conform to sample with regard to soundness, colour, veining and general texture. Care shall have to betaken that corners of the tile are not damaged. No piece which has been damaged shall be used for thatwork. Other specification as per BOQ.

Preparation of Surface and Laying

The tiles are to be laid shall be cleaned, wetted and mopped. The bedding for the tile shall be with cement mortar 1:3 (1 cement: 3 coarse sand) or as specified. The average thickness of the bedding shall be 12 mm or as specified while the thickness under any portion of the tiles shall not be less than 10 mm. Mortar shall be spread, tamped and corrected to proper levels and allowed to harden sufficiently to offer a fairly rigid cushion for the tiles to be set and to enable the mason to place wooden plank across and squat on it. Where full size tiles cannot be fixed these shall be cut (sawn) to the required size, and their edge rubbed smooth to ensure straight and true joints. After tiles have been laid surplus cement slurry shall be cleaned off.

Pointing and Finishing

The joints shall be cleaned off the grey cement slurry with wire/coir brush or trowel to a depth of 2mm to 3 mm and all dust and loose mortar removed. Joints shall then be flush pointed with white cement added with pigment if required to match the colour of tiles. Where spacer lug tiles are provided, the half the depth of joint shall be filled with epoxy or as specified on top with under filling with cement

grout without the lugs remaining exposed. The cladding shall then be kept wet for 7 days. After curing, the surface shall be washed and finished clean. The finished cladding shall not sound hollow when tapped with a wooden mallet.

Sampling and Testing

Sampling: For carrying out compressive strength, water absorption, efflorescence and dimensional tests, the samples of bricks shall be taken at random. The sample thus taken shall be stored in a dry place until tests are made.

Dimensional Tolerances: $\pm 1\text{mm}$.

Compressive Strength: Should not less than 7.5N/mm^2 and less than 10N/mm^2

Water Absorption: The average water absorption of bricks tile when tested in accordance with the procedure laid down, shall be not more than 20% by weight.

Efflorescence: The rating of efflorescence of bricks tile when tested in accordance with the procedure laid down, shall be not more than moderate. Other specification as per BOQ.

1.2.4. Tree Transplantation

- A. Roots must be trimmed before transplanting. Set up temporary supports before trimming. Perform excavation and trimming in stages. The root-cutting diameter should be 10 cm less than the planned root ball. The roots should be trimmed one after another, in a circular pattern with the trunk as the core. The wounds of the exposed roots must be smoothed. Root trimming is normally performed in spring, before new shoots start to grow, but can also be performed in summer when the part above the ground stops growing or before the leaf falling season in autumn.
- B. Digging up trees
 - a. The diameter of the excavated root system or soil ball should be five times the diameter of the base of the tree trunk, but not less than 40 cm. The depth of the excavation should be $\frac{2}{3}$ of the soil ball's diameter, but not shallower than 25 cm. The depth of the soil ball should include multiple root systems. For slow growing plants or big trees being transplanted in the non-growing season (i.e., weakly growing trees or transplantation during inappropriate season), the size of the soil ball should be increased accordingly.
 - b. When encountering thick roots, cut them with a hand saw instead of digging through, keep the wound smooth and apply healing agents to prevent infection.
 - c. Wrap the soil ball with biodegradable materials, and then with large mesh wire netting to maintain its stability.

C. Wrapping and transporting

- a. After being excavated, the tree trunk should be wrapped with protective materials (e.g., sackcloth, canvas). During transporting the tree to the new destination, cushions should be placed between the tree and the body of the vehicle, to avoid damaging the branches. Fasten the tree with ropes for safety's sake, regardless of how far it is being transported.
- b. Be gentle while loading, unloading, and handling, and avoid dragging while transporting. Ensure there are no damage to the soil ball, and no scratching and splitting of the root system. The tree should be kept intact without injuries to its root system, trunk and crown.
- c. Keep the trees being transported properly moistened, sheltered and protected from wind, strong sunlight, rain, cold weather and theft.
- d. While transporting, loading and unloading, follow traffic safety guidelines, with warning signs erected to alert passing vehicles and pedestrians.

D. Tree planting

- a. Mark the planting site with the Engineer in advance. Start digging only after confirmation. The size of the excavation should be double that of the soil ball, or at least 30 cm wider than its diameter, while the hole should be 15-20 cm deeper than the root ball. After digging, apply organic or other types of fertilizers to the base of the hole to facilitate root growth, and replace the existing soil with new soil. There should not be any rocks or impurities larger than 1 cm in diameter in the soil.
- b. The transplantation process including excavation, transporting and planting should be completed within the same day. When encountering adverse weather, apply temporary measures to protect the soil ball and the planting hole, install sheltering facilities and, if necessary, water the tree to prevent injury or withering.
- c. Before planting, place a ventilation bag on each of the four sides of the hole (Dimensions of ventilation bag: 12-15 centimetres in diameter, 1 metre in length; fillings comprising perlite, with a diameter of more than 1 centimetre). While planting, remove the wrapping materials around the soil ball, gently put the tree into the hole, and keep the trunk upright. Refill the soil surrounding the root ball, water the tree three times, compact the soil with wooden stick to enhance contact with the root system, & build a "soil wall" around the tree to retain water.
- d. Install supporting structures immediately after planting, to prevent tree leaning. Structures of less than 20 centimeters in diameter should be made up of materials of at least 5 centimeters in diameter, while structures of over 20 centimeters in diameter should be made up of materials of at least 10 centimeters in diameter, and they should be firmly pressed at least 4 inches into the soil. Protect the parts where the trunk is in contact with the structures with thick soft materials (such as plastic or fabrics), to avoid

injuries to the bark. Fasten the tree with ropes.

- e. Water the tree immediately after transplanting, and water again after 2~3 days, and then again after one week. Keep it well watered each time, to ensure sufficient water at the base of the soil ball. Meanwhile, wrap the main trunk and the first and second main branches with straw ropes or soft moist materials. Other specification as per BOQ.

1.2.5. Outdoor Signages

Signages of different sizes and shapes shall be made using Stainless Steel sheet (Grade 304) conforming to IS 5522, of minimum 16G thickness. Letters of required size shall be constructed as 3-dimensional letters from Stainless Steel sheets for outdoor signages, as may be specified in the design. All signages shall be fixed at required locations with Stainless Steel screws. Shop drawings shall be prepared by the Contractor before execution of work at his own cost and same shall be approved from Engineer-in-charge.

1.2.6. Indoor Signages

Signages of different sizes and shapes shall be made using Stainless Steel sheet (Grade 304) conforming to IS 5522, of minimum 20G thickness. Letters of required size shall be engraved/etched with approved colour on Stainless Steel sheet for indoor signages, as may be specified in the design. All signages shall be fixed at required locations with Stainless Steel screws. Shop drawings shall be prepared by the Contractor before execution of work at his own cost and same shall be approved from Engineer-in-charge. Other specification as/BOQ.

1.2.7. Glass Reinforced Concrete (GRC)

Glass Reinforced Concrete Screens shall be made with frame of thickness 50mm and perforated designer screen element within thickness of 30mm as per approved design. The GRC screens shall be casted with a layering technique using power spray methodology and have minimum weight 3.5 kg per Sq.ft. The screens should be made from 53 grade white Portland cement, fine graded quartz, silica sand and alkali resistant glass fibre. Super plasticizers and UV resistant synthetic inorganic pigments should be used for pigmentation. The material casting should take place in FRP moulds. The GRC screens' flexural strength Limit of Proportionality should be at least 6 N/mm² & Modulus of Rupture should be at least 15 N/mm² for tests done on 28 days cured samples. The fixing of panels should be 'Dry fixing' i.e., should be done with MS galvanized clamps, fixtures, screws and fasteners. All work, design, pattern and colour should be approved from Engineer-in-charge. Other specification as per BOQ.

1.2.8. Expansion Joints

Expansion Joints in roofs, walls and floors shall be provided as per CPWD specifications 2019, Volume

I sub-head 5.4.5 & 5.12

1.2.9. Cupboard Shutters

Providing and fixing Cupboard double leaf shutter/kitchen cabinet shutter with 1 mm thick pressed steel sheet door i/c 1.25mm thick pressed steel frame of minimum required section 75x25mm hinged with 3 Nos. steel butt hinges of 1.25mm thick sheet or 2 Nos. pivot hinge system at both side of frame i/c necessary fittings such as 2 Nos. M.S. tower bolts of size 150x10mm at top & bottom, 1 No. cupboard lock with lever handle i/c fixing with 3 Nos. lugs with rawl plugs, wooden plugs, screws/ Dash Fasteners etc. at both side of the frame complete as approved by Engineer-in-charge with primingcoat of approved steel primer and spray painting with textured pattern synthetic enamel paint complete as per the direction of Engineer in charge. (Measurement shall be done of the elevational area of shutters i/c frame). Other specification as per BOQ.

1.3. PLUMBING WORKS

General requirements

Scope of Work

- a) The form of Contract shall be according to the "Conditions of Contract". The following clauses shall be considered as an extension and not in limitation of the obligation of the Contractor.
- b) Work under this contract shall consist of furnishing all labour, materials, equipment and appliances necessary and required. The Contractor is required to completely furnish all the Plumbing and other specialized services as described hereinafter and as specified in the Schedule of Quantities and/or shown on the Plumbing Drawings.

- c) Without restricting to the generally of the foregoing, the sanitary installations shall include the following:

Plumbing Works

- a. Sanitary ware Installation
- b. Water Supply System (Hot & Cold).
- c. Underground water tanks with all sleeves.
- d. Sewerage & Storm water drainage system.

1.3.1. Specifications

Work under this contract shall be carried out strictly in accordance with Specifications attached with the tender and as per BOQ, CPWD specifications with upto date amendments, relevant IS standards and in case of its absence as per British Standard Code of Practice.

1.3.2. Execution of Work

- a) The work shall be carried out in conformity with the Plumbing drawings and within the requirements of Architectural, Mechanical, Electrical, Structural and Other specialized services drawings as shall be shared subsequently.
- b) The Contractor shall cooperate with all trades and agencies working on the site. He shall make provision for hangers, sleeves, structural openings and other requirements well in advance to prevent hold up of progress of the construction schedule.

1.3.3. Drawings

- i. Plumbing drawings that shall be issued to Successful Bidder shall be diagrammatic but shall be followed as closely as actual construction permits. Any deviations made shall be in conformity with the Architectural and other services drawings.
- ii. Architectural drawings shall take precedence over Plumbing or other services drawings as to all dimensions.
- iii. Contractor shall verify all dimensions at site and bring to the notice of the Engineer-in-Charge all discrepancies or deviations noticed. Decision of the Engineer-in-Charge shall be final.
- iv. Large size details and manufacturers dimensions for materials to be incorporated shall take precedence over small scale drawings.

1.3.4. Inspection and Testing of Materials

- 1.3.4.1. Contractor shall be required, if requested, to produce Manufacturers Test Certificate for the particular batch of materials supplied to him. The tests carried out shall be as per the relevant Indian Standards.
- 1.3.4.2. For examination and testing of materials and works at the site Contractor shall provide all Testing and Gauging Equipment necessary but not limited to the followings: -
 - i. Theodolite, Steel tapes
 - ii. Dumpy level
 - iii. Weighing machine
 - iv. Plumb bobs, Spirit levels, Hammers
 - v. Micrometers, Tachometers
 - vi. Thermometers, Stoves
 - vii. Hydraulic test machine
 - viii. Smoke test machine
- 1.3.4.3. All such equipment shall be tested for calibration at any NABL accredited laboratory, if required by the Engineer-in-Charge.

- 1.3.4.4. All Testing Equipment shall be preferably located in a special room meant for the purpose.
- 1.3.4.5. Samples of all materials shall be got approved before placing order and the approved samples shall be deposited with the Engineer-in-Charge or kept at site in a sample room as prepared by the Engineer-in-Charge. Any materials declared defective Engineer-in-Charge shall be removed from the site within 48 hours.

1.3.5. Reference Drawings

- 1.3.5.1. The Contractor shall maintain one set of all drawings issued to him as reference drawings.
- 1.3.5.2. All corrections, deviations and changes made on the site shall be shown on these reference drawings for final incorporation in the completion drawings. All changes to be made shall be initialed by the Engineer-in-Charge.

1.3.6. Shop Drawings

- 1.3.6.1. The Contractor shall submit to the Engineer-in-Charge the shop drawings under following conditions:
- i. Showing any changes in layout in the plumbing drawings.
 - ii. Equipment layout, piping and wiring diagram.
 - iii. Manufacturers or Contractor's fabrication drawings for any materials or equipment supplied by him.
- 1.3.6.2. The Contractor shall submit two copies of catalogues, manufacturer's drawings, equipment characteristics data or performance charts as required by the Engineer-in-Charge.

1.3.7. As built Drawings

- 1.3.7.1. On completion of work, Contractor shall submit two prints of "as built" drawings to the Engineer-in-Charge. These drawings shall have the following information.
- (a) Run of all piping, diameters on all floors, vertical stacks and location of external services.
 - (b) Ground and invert levels of all drainage pipes together with location of all manholes and connections upto outfall.
 - (c) Run of all water supply lines with diameters, locations of control valves, access panels.
 - (d) Location of all mechanical equipment with layout and piping connections.
- 1.3.7.2. No completion certificate shall be issued unless the above drawings are submitted. Contractor shall provide two sets of catalogues, service manuals manufacturer's drawings, performance data and list of spare parts together with the name and address of the manufacturer for all electrical and mechanical equipment provided by him.

1.3.8. Testing

Piping and drainage works shall be tested as specified under the relevant clause(s) of the specifications. Tests shall be performed in the presence of the Engineer-in-Charge.

All materials and equipment found defective shall be replaced and whole work tested to meet the requirements of the specifications.

Contractor shall perform all such tests as may be necessary and required by the local authorities to meet Municipal or other bye-laws in force.

Contractor shall provide all labour, equipment and materials for the performance of the tests.

1.3.9. Cutting of Water Proofing Membrane

No walls, terraces shall be cut for making and opening after water proofing has been done without written approval of Engineer-in-Charge.

1.3.10. Cutting of Structural Members

No structural member shall be chiseled or cut without the written permission of the Engineer-in-Charge.

Water Supply System

1.3.11. Grab Bar

Providing and fixing of 600mm wall mounted, Movable (horizontally and vertically) Stainless Steel 35mm diameter Handicap/ Disabled Grab Bar (U shape) including cutting & making good the walls.

1.3.12. Mirror

Providing and fixing beveled edge mirror of superior glass (of approved quality) desired thickness, fixed with stainless steel studs, complete with cutting, making holes, studs, all fittings, screws, washers and making good the walls as specified BoQ.

1.3.13. Water supply pumps

1.3.13.1. Borewell Pumps

The pumps shall be vertical, submersible, multistage centrifugal, stainless steel (304) casing, stainless (304) impeller, stainless steel (316) shaft, ceramic bearings, tungsten carbide shaft protection bushes and mechanical seal driven suitable rated motor with suitable RPM, $415 \pm 10\%$ Volts, 50 Cycles, AC3 – phase. Each pump shall be capable of operating within a performance pressure characteristic range sufficient below and above the required working pressure.

The Pumps shall conform to Indian standard IS: 8034. Pumps and motors shall be mounts on a common MS structural base plate. The pump shall be water cooled coupled to induction motor of suitable H.P

and R.P.M specified in schedule of quantities. Pumping set shall be provides with a Gun Metal “Bourden” type pressure gauge with gunmetal isolation cock and connecting piping. The pump set shall be provided with gun metal gate valve of appropriate sizes on delivery & non-return valve of appropriate size and a pressure gauge with cock shall be provided on the delivery line.

1.3.13.2. Domestic Water Supply Pumps

Domestic water transfer pumps shall be multistage, vertical stainless steel pumps, having stainless steel casing, stainless steel pump foot and diffusers, stainless impeller, stainless steel shaft, ceramic bearings, tungsten carbide shaft protection bushes and mechanical seal driven by suitable kW, RPM, 400/440 Volts, Cycles, AC 3 –phase TEFC vertical flange motor. Each pump shall be capable of operating with in a performance pressure characteristic range sufficient below and above the required working pressure. Pumps shall be suitable for manual operation. Pumps and motors shall be mounts on a common MS structural base plate. Each pump shall be provides with a totally enclosed fan cooled induction motor of H.P and R.P.M specified in schedule of quantities Each pumping set shall be provides with a Gun Metal “Bourden” type pressure gauge with gunmetal isolation cock and connecting piping. Appropriate vibration eliminating pads shall be provides with each pump. The pump set shall be provided with gun metal gate valve of appropriate sizes on delivery. a non-return valve of appropriate size and a pressure gauge with cock shall be provided on the delivery line. Suction and delivery lines of the pumps shall be provided with double flanged reinforced Neoprene flexible pipe connectors. Connectors shall be suitable for a working pressure of each pump as specified in Schedule of Quantities

1.3.13.3. Sump pumps

Pump shall be integral with submersible motor on a common shaft. The pumps shall be as specified in the BoQ.

The pump set shall be installed in vertical position in sumps with level controller cum operated float switches.

Pump casings shall be aluminum and impellers of SS. All pumps shall have combination ball and roller bearings and shaft seals should be mechanical. Motor shall be submersible and shall be rated for minimum HP specified or the BHP absorbed in the operating range of the pump.

1.3.14. System Description

The system shall be supplied as complete set including suction and discharge common manifolds, non-return valves, isolating valves, pressure transmitter on the discharge side and electrode at the suction tank. Domestic Water Supply Pumps shall be suitable for manual operation.

1.3.14.1. Submersible Pump

These shall be fully submersible with a fully submersible motor. The pumps shall be provided with an automatic level controller and all interconnecting power and control cabling which shall cause the pumps to operate when the water level in the sump rises to a preset level and stop when the preset lowlevel is reached.

Pumps for drainage shall be single stage, single entry.

Pump shall be C.I. casing and C.I. two vane open type with a dynamically balanced impeller connected to a common shaft of the motor. The vane for sewage pump will be open type, while for drainage pump, etc. it will be of semi open type. The MOC of the sump shall be in accordance to schedule of quantity.

Stuffing box shall be provided with mechanical seals.

Each pump shall be provided with a suitably rated induction motor suitable for 415 volts, 3 phase, 50 Hz A.C. power supply. Each pump shall be provided with in built liquid level controller for operating the pump between predetermined levels.

The pumping set shall be for stationary application and shall be provided with pump connector unit. The delivery pipe shall be joined to the pump through a rubber diaphragm, and bend and guide pipe for easy installation.

Pump shall be provided with all accessories and devices necessary and required for the pump to make it a complete working system.

Sump pump shall be complete with level controllers, power and control switch gear, Auto/off/Manual switches, pumps priority selections and control and power cabling upto motor and controller/probes etc. (Including earthing). Level control shall be such that one pump starts on required level, 2nd pump cuts in at high level and alarms is given at extra high level. All level controllers shall be provided with remote level indications.

1.3.14.2. Motor Design

The pump motor shall be a squirrel cage induction, housed in air filled water-tight enclosure. Oil filled motors are not acceptable. The stator windings shall be class 'H' insulation for submersible type.

The stator shall be heat shrunk fitted into the enclosure and shall not use bolts, pins or other fasteners that penetrate through the stator enclosure. The starter shall be equipped with a thermal switch embedded in series in the coils of the stator windings to protect the stator from wheel.

The motors shall be designed for continuous running duty type at 415 volts, 3 phase, 50 Hz power supply and capable of sustaining a minimum of 20 starts/stops per hour.

Between stator housing and pump, a tandem seal arrangement will be provided with an oil barrier. Both seals run in oil, allowing dry running without seal damage. Both seals shall be of the rubber bellows or metallic bellow type with positive drive between shaft and rotating seal face.

Electrical works

Electrical equipment shall be suitable for electrical voltage specified in the bill of quantities and as required by local authorities. Motors shall be for heavy duty TEFC compatible for the duties of the pumps. Motors shall be rated as specified in the BoQ. Each motor shall be provided with a weather proof terminal. Connections to all motors shall be made with waterproof flexible connections with suitable bushes and terminal lugs.

Starters for motors shall be fully automatic type with push buttons. Direct on line (DOL) for motor up to 10 HP. Starters for motors above 10 H.P. shall be automatic star-delta starters. Motor control centre for the entire plant shall be dust and vermin proof construction fabricated from corrosion resistant M.S. sheets and comprising of:

- One incoming MCCB.
- Copper bus bar in separate chamber of ample capacity.
- One isolation MCB/ MCCB for each motor.
- One starter of required type for each motor.
- One set of ON/OFF indicating lamps for each motor.
- One voltmeter with selector switch on incoming main.
- One ampere meter for each motor.
- One single phasing preventer for each motor.
- All interconnecting colour coded wiring within the control center.

Any other devices and accessories necessary and required for a complete working system and as required by local authorities. All power and control cabling from MCC panel to all motors and controls shall be 1100 volts grade with numbers of the cores necessary and required conforming to relevant IS. Entire electrical installation shall be earthed in accordance with local electrical rules. Slotted tray running on wall shall be provided for taking cables from MCC to various motors.

1.4. FIRE FIGHTING WORKS

Scope of Work

Without restricting to the generally of the foregoing, the sanitary installations shall include the following: -

Fire Fighting Works

- a. Hydrant System
- b. Fire Extinguishers

1.4.1. Fire Pump

- a) The fire pump shall be single stage suction centrifugal type with split casing type and direct driven by electric motor as specified in schedule of quantities. The pump rating and performance shall conform to the equipment schedule and meet the TAC duty requirements.
- b) Pump casing shall be of close-grained cast iron with bronze impeller. The shaft sleeve shall be brass or SS 304 and the trim shall be brass or bronze.
- c) Pump shall be capable of delivering 150% of the rated capacity at 65% of the rated head and the no-delivery head shall be not more than 140% (150% in case of end suction type) of the rated delivery head.

The pump casing shall withstand 1.5 times the no-delivery pressure or 2 times of the duty pressure whichever is higher.

- d) The pump shall be electrically driven with direct flexible coupling.
- e) The electric driven motor shall be squirrel cage induction conforming to IS 325 and rated for continuous duty (S1). Motor shall have not less than class F insulation and minimum enclosure of IP22. The starters shall be air cooled fully automatic star delta or auto transformer type. Starters shall conform to IS 8544 and rated for AC-3 duty conditions.
- f) Drive rating shall be based on the largest of the following:
 - i) Rated pump discharge at rated head
 - ii) 150% of rated discharge @ 65% of rated head
 - iii) Maximum power absorbed by the pump in its operating range i.e. no-delivery to free discharge.
Other specification as per BOQ.

Accessories

The Fire Pumps shall be complete with the following accessories:

- a) Suction and discharge eccentric reducers
- b) Pump coupling guard
- c) Common base frame, fabricated mild steel or cast iron.

Each pump shall have independent set of pressure switches. The pressure switch shall be snap action SPDT switch rated 10A @ 220 V operated through a stainless-steel diaphragm. The switch shall have a pointer for manual adjustment of set point, and all electrical connections shall be terminated in a screwed terminal connector. The entire unit shall be encased in a cold drawn steel (heavy gauge) enclosure. The

diaphragm shall be designed for a maximum operating pressure of the system. Each pressure switch shall be provided with a pressure gauge in parallel as shown on the drawings and all gauges and pressure switches shall be mounted in an instrument panel with necessary control piping and drainage facility. For other specifications BOQ items shall be followed.

System operation and control panels

- a. The fire pump shall be started automatically on loss of pressure and the operation sequence of the booster and fire pumps shall be as follows:
 - i. The Fire Pump shall start when the system pressure drops by 1.0 kg/cm² and shall continue to run till manually switched off.
- b. The motor starters (direct on line or star-delta) shall consist of electrically actuated contactors. The starter shall be complete with ON-OFF push buttons, timers and auxiliary contacts and shall be fully automatic. There shall be an indicating lamp with each of the pumps and an ammeter and selector switch with the fire pumps. Fire pump starting shall be annunciate through an electric siren.
- c. The starter along with isolator shall be housed in a 14 SWG MS box duly rust inhibited through a process of degreasing and phosphating.
- d. All cabling to and from the pumps to starter and control switch shall be carried out through armoured PVC cables of approved makes. Cables shall be laid in accordance with section "M V CABLING". The pump motors and panels shall be double earthed in accordance with IS 3043 or as shown on drawings and as approved. Other specification as per BOQ.

1.4.2. Fire hydrants and hose reels

- a. Hydrants shall be provides internally as shown on the drawings. Internal hydrants shall be providing at each landing of and escape staircase and additionally depending on the floor area as shown on drawings. Landing valve shall be single headed gunmetal valve with 63 mm dia outlets and 80mm inlet conforming to IS 5290. Landing valve shall have flanged inlet and instantaneous type outlets and mounted at 1.0m above the floor level. Instantaneous outlets for the hydrants shall be of standard pattern approved and suitable for 63mm dia fire brigade hoses. Wherever necessary, pressure reducing orifices plate and shall be provided so as to limit the pressure to 3.5 kg/sqcm or any other rating as required by the Local Fire Authority.
- b. Each landing valve shall have a hose reel cabinet as shown on drawings.
 - i. Landing valve with single 63 mm dia outlet and 80 mm dia inlet.
 - ii. First-aid hose reel with 30 m long 25 mm dia high pressure double braided rubber hose (IS:444 marked) with 25 m dia Ball Valve.

- iii. 2 Nos. 15.0-Meter-long 63 mm dia Reinforced Rubber Lined (RRL) hoses with gun metal I.S. marked instantaneous couplings.
- iv. One-gun metal branch pipe.
- c. The First Aid Hose shall conform to IS 884 and be wound on a heavy-duty circular hose reel with a bracket. The hose shall be permanently connected on one end to the Wet Riser through a 25m Ball Valve with necessary hose adapter and a gun metal nozzle at the other end.
- d. Hoses shall be in two lengths of 15.0 m each, of RRL type with instantaneous couplings, neatly rolled into bundles and held in position with steel brackets. Hoses shall be tested and certified by the manufacturer, to withstand an internal water pressure of not less than 35 kg / sqcm without bursting. The hose shall also withstand a working pressure of 7 kg / sqcm without leakage.
- e. The hose cabinet shall be fabricated from 2mm mild steel sheet duly rust inhibited through a process of degreasing and phosphating. The cabinet shall have double flap hinged doors with 4mm clear glass and shall have necessary openings for riser main and brackets for all internals. The cabinet shall receive two coats of red oxide primer both inside and outside before two after coats of final paint of approved colour shade.
- f. The fire brigade connection shall consist of two / three/four headed as specified in BOQ 63mm dia gun metal outlets with built-in check valve and drain plugs connected to a 150mm dia outlet connection to the water reservoir or to the hydrant main. The fire brigade collecting head shall conform to IS 904. Other specification as per BOQ.

Test & commissioning

1. The fire pump starting and stopping shall be tested by opening the test valve and record the following and the valves should be as furnished below:
 - i. System pressure at start-up : 2.0 kg/sqcm
 - ii. System pressure at stop : 3.5 kg/sqcm
 - iii. Time elapsed from start to stop : 2 Seconds

Mode of measurement

Fire pump with mounting frame, excluding concrete foundation shall be measured per unit. Instrument panel with pressure gauges, pressure switches, control piping etc. shall be measured as one unit. Control cabling from pressure gauge panel to the respective starters shall be measured in running meter and paid at unit rates.

1.4.3. Piping for Fire Fighting System

External

- 1.4.3.1. All External pipes shall be, unless otherwise specified, heavy quality mild steel tubes to IS 1239 using wrought GI steel heavy duty screwed fittings. Flanges shall be provided to mate with valves and other equipment and shall conform to IS 6392. Flanges shall be screwed type. Flanges shall be rated for 2.0 N/sqmm.
- 1.4.3.2. Black mild steel pipes, when laid underground, shall be protected against corrosion by two coats of hot bitumen and 2mm thick wrapping of pypkote. Fittings shall be weld able wrought iron, suitable for butt welding and 10% of the welded joints shall be radio graphically tested and found in order. The welded joints shall be random selected for testing in consultation with the Engineer-in-charge. All flanges shall be slip-on welded type to IS 6392 with a 3mm fibre-reinforced Teflon gasket and rated for 2.0 N/sq. mm.
- 1.4.3.3. Underground mains shall be laid not less than 750 mm below the ground level and shall be at least 2m away from the building face and supported on concrete pedestals at every 3.5m and held on with galvanised iron clamps. Concrete thrust anchors shall be provided at all bends and tees as shown on drawing and as directed. All excavation for pipe laying shall be carried out with sufficient width for making proper joints. Backfilling shall be done only after the piping is hydro-statically pressure tested. Piping shall be constantly kept clean till tested.
- 1.4.3.4. All valves shall be housed in brick masonry chambers over 150mm cement concrete (1:3:6) foundation. The brick walls of the chamber shall be plastered inside and outside with 20mm cement sand plaster 1:4 with a floating coat of neat cement. Chambers shall be 650 x 650 mm clear for depths upto 1200 mm and 1000 x 1000 mm for depths beyond or as specified in the BoQ. Each chamber shall have a cast iron surface box approved by the Engineer in-charge.
- 1.4.3.5. Piping laid above ground shall be supported on cement concrete (1:2:4) pedestals raising the bottom of the pipe at least 150mm over the ground level and held to the pedestals with galvanised clamps. Pedestal shall be made at 3.0m centre to centre and as shown on drawings. Cement concrete 1:2:4 thrust anchor shall be provided at all tee-off points and change of direction as shown on drawings and as required. Pipes laid on walls and ceiling shall have galvanised steel brackets. Other specification as per BOQ.

Internal

- 1.4.3.6. All internal pipes shall be, unless otherwise specified, heavy quality mild steel tubes to IS 1239 using wrought steel heavy duty screwed fittings. Flanges shall be provided to mate with valves and other equipment and shall conform to IS 6392. Flanges shall be screwed type. Flanges shall be rated for 2.0 N/sqmm.

1.4.3.7. Valves shall be suitable for external piping.

1.4.3.8. All pipes shall be of approved make and best quality without rust marks. Pipes and fittings shall be fixed in a manner as to provide easy accessibility for repair, maintenance and shall not cause obstruction in shafts, passages etc. Pipes and fittings shall be fixed truly vertical, horizontal or in slopes as required in an neat workmanship manner. Pipes shall be securely fixed to walls and ceilings by suitable supports at intervals specified. Only approved type of anchor fasteners shall be used for RCC ceiling and walls.

1.4.3.9. All pipes shall be adequately supported from ceiling or walls through structural supports fabricated from mild steel structural e.g., rods, channels, angels and flats generally as shown on drawings. Fasteners shall be shear type anchor fasteners in concrete walls and ceilings and wrought steel spikes of at least 75mm long in brick walls. All pipes support shall be painted with 1 coats of red oxide primer and two coats of black enamel paint.

1.4.3.10. All low point loops in the piping shall be provided with 25mm Ball Valves with rising spindle for draining the system. All valves shall have screwed brass caps. Likewise, 25mm gun metal air vents shall be provided at all high point loops to prevent air-locking.

1.4.3.11. All piping shall have flanged joints at about 25m intervals to facilitate easy maintenance.

Pipe Jointing

1.4.3.12. All pipes shall be provided with threaded joints up to 50mm diameter and welded joints for pipe above 50mm diameters. Hold tite shall be used for sealing.

1.4.3.13. All welded joints shall be tested by radiography test.

1.4.3.14. Joints between CI and GI pipes shall be made by providing a suitable flanged tail or socket piece and MS flange on the GI pipe. Flanges shall have appropriate number of holes and shall be fastened with nuts, bolts and 1.5mm thick compressed asbestos gasket.

a. Valves and other accessories

b. Gate Valves

i. Sluice / Gate valves shall be used for isolation of flow in pipe lines For sizes upto 65 mm, gate valves shall be outside screw rising spindle type and shall be as per IS: 778 Class-I and Class-II, as applicable. For sizes 80 mm to 300 mm, gate valve shall be as per IS: 780, PN=1.0 and shall be of inside screw and non-rising type and cast iron double flanged.

ii. Gate valves shall be provided with a hand wheel, draining arrangement of seat valve and locking facility (as required). Gate valves shall have back setting bush to facilitate gland renewal during full open condition.

- iii. The Body, bonnet, Stuffing Box, cap and hand wheel shall be of cast iron to IS:210, grade FG 200 / 260. The non-rising spindle shall be of solid forged high tensile brass or carbon steel to AISI 304 construction. The Body seating and wedge ring shall be of solid leaded gun metal. The Bonnet gasket shall be of high quality rubber.
 - iv. The Valve shall be PN 1.0 rated but shall withstand tests of upto 20 kg / cm². The ends shall be flanged. The batch number of the valve shall be punched on the top of the flange. The spindle shall be removable type, and shall be easily rotated.
- c. Pressure Switch
- i. The Pressure switches shall be employed for starting and shutting down operation of pumps automatically, dictated by line pressure. The Pressure Switch shall be diaphragm type. It shall be suitable for line pressures upto 15 kg / cm². The scale range for cut in and cut out shall be from 0 to 10 kg / cm².
 - ii. The Switch shall be suitable for consistent and repeated operations without change in values. It shall be provided with IP: 66 water and environment protection.
 - iii. The enclosure shall be of aluminium and pressure element and wetted parts shall be of stainless steel. The switch shall be snap acting type with 1 number N O / N C contact.
- d. Pressure Vessel
- i. The Pressure Vessel shall be provided to compensate for slight loss of pressure in the system and to provide an air cushion for counter acting pressure surges whenever the pumping set comes into operation. It shall be normally partly full of water; the remaining being filled with air which will be under compression when the system is in normal operation.
 - ii. Pressure vessel shall be fabricated from 8-10 mm thick MS plate with dished ends and suitable supporting legs. It shall be provided with a 50 mm dia flanged connections from pump, one 25 mm drain with ball valve, one water level gauge and 25 mm sockets for pressure switches. The pressure vessel shall be hydraulically tested as required.
 - iii. The Pressure Vessel shall be for Hydrant Systems. The Pressure Switches shall be mounted on the drain end of each Vessel. The Vessel shall also be provided with an air release valve mounted at the top.
- e. Pressure Gauge
- The Pressure Gauge shall be constructed of die cast aluminum and stove enameled. It shall be weather proof with an IP 55 enclosure. It shall be a stainless steel Bourden tube type Pressure Gauge with a scale range from 0 to 16 Kg / cm² and shall be constructed as per IS: 3624. Each Pressure Gauge shall have

asiphon tube connection. The Shut off arrangement shall be by Ball Valve.

f. Ball Valve

The Ball Valve shall be made from die cast brass and tested to 14 Kg/cm² pressure.

- i. The valve shall be internally threaded to receive pipe connections.
- ii. The Ball shall be made from brass and machined to perfect round shape and subsequently chrome plated. The seat of the valve body- bonnet gasket and gland packing shall be of Teflon.
- iii. The handle shall be of chrome plated steel with PVC jacket. The handle shall also indicate the direction of 'open' and 'closed' situations. The gap between the ball and the teflon packing shall be sealed to prevent water seeping upto 14 Kg/cm² pressure.
- iv. The handle shall also be provided with a lug to keep the movement of the ball valve within 90 degree. The lever shall be operated smoothly and without application of any unnecessary force.

g. Non Return Valve

- i. Non-return valves shall be cast iron spring action swing check type. An arrow mark in the direction of flow shall be marked on the body of the valve. The valve shall bear IS: 531 certifications.
- ii. The Valve shall be of cast iron body and cover. The internal flap in the direction of water shall be of cast iron and hinged by a hinge pin of high tensile brass or stainless steel. Cast iron parts shall conform to IS: 210, grade 200 / 260 type.
- iii. The gasket shall be of high-quality rubber and flap seat ring of leaded gun metal to BS 1400 LG 2C. At high pressure of water flow the flapper shall seat tightly to the seat. The Valve shall be capable of handling pressure upto 15 kg/cm².

h. Butterfly Valve

- i. The Butterfly Valve shall be suitable for waterworks and tested to minimum of 16 kg / sq cm pressure. The Valves shall fulfil the requirements of AWWA (American Water Works Association) C 504, API609 and MSS-SP-67.
- ii. The body shall be of cast iron to IS: 210 in circular shape and of high strength to take the minimum water pressure of 10 kg/cm². The disc shall be heavy duty cast iron with anti-corrosive epoxy or nickel coating.
- iii. The valve seat shall be of high-grade elastomer or nitrile rubber. The Valve in closed position shall have complete contact between the seat and the disc throughout the perimeter. The elastomer rubber shall have a long life and shall not give away on continuous applied water pressure. The shaft shall be of EN 8 grade carbon steel.

- iv. The Valve shall be fitted between two flanges on either side of pipe flanges. The Valve edge rubber shall be projected outside such that they are wedged within the pipe flanges to prevent leakage.
- v. The Valves shall be supplied with manual gear operated opening / closing system by lever.

i. Pipe supports

All pipes whether horizontal or vertical shall be suitably supported using galvanized mild steel clamps/clevis hanger manufactured of good quality as approved by engineer in-charge.

j. Vertical Pipes

The pipes running vertical shaft shall be supported by galvanised mild steel rigid clamps fixed to wall with anchor bolts and studs.

When the horizontal distance between the centre line of two adjacent pipes is less than 300 mm a powder coated rail shall be fixed to wall the pipes independently clamped to the rail with 'U' bolt clamps.

k. Horizontal Pipes

Pipes running horizontal shall be supported from structural beam/slab by using appropriate galvanised m.s. pipe clevis hangers. Other specification as per BOQ.

The spacing of supports shall be as follows:

| GI Pipes/MS Pipes | | CI Spun Pipes | |
|-------------------|--------------|-------------------|--------------|
| Internal Dia (mm) | Spacing (mm) | Internal dia (mm) | Spacing (mm) |
| 15 | 1800 | 75-150 | 2700 |
| 20,25 | 2400 | 200-250 | 3000 |
| 32 | 2700 | 300 | 3600 |
| 40-50 | 3000 | | |
| 65-80 | 3600 | | |
| 100 | 4000 | | |
| 150 | 4500 | | |

Supports for horizontal piping longer than 15m in a stretch shall be provided with swivel clamps. Otherwise, the clamps shall be universal clamps or rigid clamps as required by the project engineer.

Fixing of clamps/rails etc.

All clamps, rails and accessories shall be fixed to the structure (beam, slab, walls etc.) by using approved good quality anchor fasteners of appropriate size.

1. Painting

All exposed piping for firefighting shall be distinctly painted `Fire red' shade 536 to IS:5-2007. Pipes shall first receive two coats of red oxide primer uniformly applied and two coats of oil paint applied thereafter. All pipes support shall be painted black as specified for support & clamps.

Painting Schedule

1.4.3.15. All equipment and piping shall be painted in accordance with the following colour code:

| Equipment | Colour | Distinguishing Mark |
|---|---|---------------------|
| a) Pump motors | Fire Red Shade No.536 to IS: 5 -2007 | |
| b) Internal piping | " | |
| c) Landing valves & Hose reel cabinets | " | |
| d) External Hydrants | " | |
| e) Fire brigade connection | " | |
| f) Priming tank | " | |
| g) Air vessel | " | |
| h) Electric panels | Black & Red | |
| i) Fire Alarm Panel | Black & Red | |
| j) Repeater panel | Black & Red | |
| k) Break Glass Unit | Fire Red | |
| l) Hooters/Speakers | Fire Red | |
| m) Sprinkler pipes | Fire Red | |

1.4.3.16. All surfaces to be painted shall be thoroughly cleaned with wire brush to remove completely rust and other extraneous substances. Over the cleaned surfaces one coat of red oxide primer shall be applied

completely covering the exposed surfaces. Finishing coat of enamel paint shall be applied one day after the prime coat, after ensuring that the paint is dry. The second coat shall be done before the installation is handed over and after approval to do so from the Engineer-in-charge.

1.4.3.17. Testing & commissioning

All piping after installation shall be tested for a hydrostatic test pressure of 10.5 kg/sqcm or 1.5 times the working pressure (whichever is less) maintained for 24 hours. All joints and valves shall be checked for leaks and rectified and retested. During testing all valves except drain & air valves shall be kept fully open.

Mode of measurement

1.4.3.18. All external piping shall be measured along the centre line of the pipe and paid per unit length and shall include:

1.4.3.19. All pipes & fittings

1.4.3.20. Bituminous coating

1.4.3.21. All internal piping shall be measured similarly but shall include for the pipe supports and clamps.

1.4.3.22. All valves, air valves, drain valves together with flanges or tail pieces shall be measured per unit.

1.4.3.23. All excavation and concrete supports and thrust blocks shall be measured as per drawing and paid for percum.

1.4.3.24. The cost of pipe supports described above form part of the rate quoted for piping and no extra shall be payable on the account.

1.4.4. PORTABLE FIRE EXTINGUISHERS & EXIT SIGNAGES

1.4.4.1. Scope

The scope of work covers the supply and installation of portable fire extinguishers. The following types are envisaged in these specifications and provided as shown in the schedule of portable fire extinguishers.

- ABC Dry powder extinguisher
- Carbon-dioxide extinguisher

1.4.4.2. Standards

The following standards and rules and regulations shall be applicable:

Fire protection manual of the tariff advisory committee, Fire Insurance Association of India

IS:2176 : Portable fire extinguisher Dry power type

IS:2878 : Portable fire extinguisher carbon-dioxide type

Local Fire Brigade/Authority standards mean the latest.

1.4.4.3. Extinguishers

Carbon dioxide type

- a. The extinguishers shall be rated for 4.5 and 9 kg by weight or carbon dioxide, unless stated otherwise. The contents shall be with a filling ratio not exceeding 0.667.
- b. The body shall be steel cylinder made according to IS:2872 and approved by the chief controller of explosives.
- c. The discharge head shall be simple and safe to operate conforming to IS:3224 with a safety release to IS:5903 set to 18.0 to 20.0 N/sqmm. A syphon tube of copper or PVC shall be fitted. A non-conducting discharge horn and a high pressure hose (27.5 N/sqmm pressure) shall be fitted with each extinguisher.
- d. The discharge system shall be designed to expel 95% of the contents in continuous discharge as follows:

| Capacity (kg) | Time (Sec.) |
|----------------------|--------------------|
| 4.5 | 10 - 24 |
| 9.0 | 15 - 36 |

ABC Dry Powder type

- a. The capacities envisaged are 2 kg & 6 kg. The filling pressure shall be 0.95 +/- 0.055 N/sqmm.
- b. The body shall be cylindrical in shape and made of cold rolled carbon steel grade D/DD or hot rolled steel plate with radiographically tested welded construction. Plate thickness shall conform to IS:11108.
- c. Discharge valve mechanism shall be a simple and safe squeeze grip valve. 4.5 kg and above capacity shall have a high pressure (0.5 N/sqmm) hose and non-conducting horn and shall also be provided with a pressure gauge. 95% of the contents shall be discharged as follows:

| Capacity (kg) | Time (sec) | Throw (m) |
|----------------------|-------------------|------------------|
| 2.00 | 8 - 16 | 2 |
| 6.00 | 15 - 24 | 4 |

- d. The internal and external components and surface shall be treated for anti-corrosion as for dry powder type extinguishers.

1.4.4.4. General requirements

- a. All extinguishers shall be standard products approved by the Tariff Advisory Committee and Local Fire Authority and manufactured and tested strictly in accordance with the relevant Indian Standard. All markings and test results shall be stamped in the appropriate colour markings accordingly to the Indian Standards.
- b. All extinguishers shall have a structurally designed galvanised steel handle and also a suitable wall mounting bracket.

List of Standard Codes

| S.No. | IS Code No. | Description |
|-------|-------------------------|--|
| 1. | IS:780:1984 | Specification for sluice valve for water works purposes (6th rev.) (50 to 300 mm size) (amendment 3) |
| 2. | IS:13095:1991 | Butterfly valves for general purposes |
| 3. | IS:5312 (part 1) : 2004 | Swing check type reflux valves (non-return valve): part 1 single door pattern |
| 4. | IS:884:1985 | Fire aid hose reel for fire fighting |
| 5. | IS:901:1988 | Coupling double male and female instantaneous pattern for fire fighting |

| S.No. | IS Code No. | Description |
|-------|------------------|--|
| 6. | IS:903:1993 | Fire hose delivery coupling, branch pipe, nozzles and nozzles spanner |
| 7. | NBC-2016 Part IV | National building code of India 2016 |
| 8. | | Central public works division (CPWD) Part-V, wet riser system for firefighting 2020, Govt. of India |
| 9. | IS:3844-1989 | Code of practice for installation and maintenance of internal fire hydrants and hose reels on premises |
| 10. | IS:2190:2010 | Code of practice for selection and maintenance of first-aid fire extinguisher |
| 11. | IS:6382:1984 | Code of practice for design and installation of fixed system carbon dioxide fire extinguishing system |
| 12. | SP:35 (s&t)-1987 | Hand book on water supply & drainage by bureau of Indian standards |
| 14. | IS:933-1989 | Specifications for portable chemical from fire extinguisher |
| 15. | IS:2171-1999 | Specifications for portable fire extinguishers, dry power |

1.5 ELECTRICAL WORKS

1.4.5. Switchgears & Switchboards Standards and codes

| | | |
|--|--|--|
| | <u>Specification for low voltage switchgear and control gear</u> | |
|--|--|--|

| | | |
|--|--|-------------------------------------|
| | <ul style="list-style-type: none"> • General Rules | IS 13947 Part-1 : 1993 |
| | <ul style="list-style-type: none"> • Circuit breaker | IS 13947 Part-2 : 1993 IEC-62271 |
| | <ul style="list-style-type: none"> • Switches, disconnectors, switch disconnectors and fuse combination units | IS 13947 Part-3 : 1993 |
| | <ul style="list-style-type: none"> • Low voltage switchgear and control gear Specification - Control circuit devices and switching elements | IS 8623 |
| | <ul style="list-style-type: none"> ➤ Electro mechanical control circuit devices | IS 13947 Part-5 : Sec-1 : 2004 |
| | <ul style="list-style-type: none"> ➤ Proximity switches | IS 13947 Part-5 : Sec-2 : 2004 |

| | | |
|--|--|-------------------------------|
| | Guide for uniform system of marking and identification of conductors and apparatus terminals | IS 113553 : 1985 |
| | <u>Electrical relays for power system protection</u> | |
| | General introduction and list of parts | IS 3231 Part-0 : 1986 |
| | <ul style="list-style-type: none"> • General requirement | |
| | <ul style="list-style-type: none"> ➤ Contact performance | IS 3231 Part-1 : Sec-1 : 1986 |
| | <ul style="list-style-type: none"> ➤ Insulation tests | IS 3231 Part-1 : Sec-2 : 1986 |
| | <ul style="list-style-type: none"> ➤ High frequency disturbance test for static relay | IS 3231 Part-1 : Sec-3 : 1986 |
| | <ul style="list-style-type: none"> • Requirements for principal families | |
| | <ul style="list-style-type: none"> ➤ All or nothing relays | IS 3231 Part-2 : Sec-1 : 1987 |
| | <ul style="list-style-type: none"> ➤ General requirement for measuring relay | IS 3231 Part-2 : Sec-2 : 1987 |
| | <ul style="list-style-type: none"> ➤ General requirements for thermal relay | IS 3231 Part-2 : Sec-3 : 1987 |
| | <ul style="list-style-type: none"> • Requirements for particular group or relays : Biased (percentage) differential relay | IS 3231 Part-3 : Sec-3 : 1987 |
| | <ul style="list-style-type: none"> • Requirements for particular group or relays : Directional relays and power relays | IS 3231 Part-4 : Sec-3 : 1987 |

| | | |
|--|--|-------------------------|
| | Specification for low voltage switchgear and control gear assemblies : | |
| | <ul style="list-style-type: none"> Requirements for type tested and partially type tested assemblies | IS 8623 : Part 1 : 1993 |
| | <ul style="list-style-type: none"> Particular requirements for bus bar trucking system (bus way) | IS 8623 : Part 2 : 1993 |
| | <ul style="list-style-type: none"> Particular requirements for equipment where unskilled person have access for their use | IS 8623 : Part 3 : 1993 |
| | Code of practice for selection, installation, and maintenance of switchgear and control gear | |
| | <ul style="list-style-type: none"> General | IS 10118 Part-1 : 1982 |
| | <ul style="list-style-type: none"> Selection | IS 10118 Part-2 : 1982 |
| | <ul style="list-style-type: none"> Installation | IS 10118 Part-3 : 1982 |
| | General requirement for switchgear and control gear for voltage not exceeding 1000 volt AC or 1200 volt DC | IS 4237 : 1982 |

1.4.5.1. Switchgear

A. Molded Case Circuit Breakers (MCCB)

- Type Molded case circuit breaker
- Operating voltage 415/690-volt 3 phase 50 Hz
- Insulation Voltage - 690 volts
- Current rating - as per Schedule of Quantities
- Fault Level withstand I_{cs} - As per Schedule of Quantities
- I_{cu} - 100% I_{cs}
- I_{cw} - 100% I_{cs}
- Isolation function - as per IEC 60947-2 Section 7.12
- Insulation - class II insulation between the front panel and internal power circuits
- Cubicle mounting - Fixed unless otherwise specified

- Operating mechanism - Trip free
- Independent Manual spring closing (IMS) or motor wound spring closing mechanism (MWS) as per Schedule of Quantities
- No of Poles - 3 or 4 as required
- All current carrying parts - Silver plated
- Arcing contacts shall be provided to protect the main contacts and shall be separate from the main contacts and easily replaceable.
- Arc chutes shall be provided for each pole, and shall be suitable for being lifted out for the inspection of the main and the arcing contacts.
- Common Operating handle required for three phase MCCBs for simultaneous operation and tripping of all the three phases.
- Indications and Operations integral with ACB on front
 - a. Mechanical ON/OFF/ Tripped indication
 - b. Operating handle
 - c. Mechanical trip push button
- Accessories - Following accessories shall be provided as required
 - i. Under voltage trip
 - ii. Shunt trip
 - iii. Alarm switch
 - iv. Auxiliary switch
- Circuit Breaker Interlocking - Interlocks shall be provided to ensure the following:
 - i. Handle interlock to prevent unnecessary manipulations of the breaker.
 - ii. Door interlock to prevent door being opened when the breaker is in ON position.
 - iii. DE interlocking device to open the door even if the breaker is in ON position.

Sheet steel hinged lockable doors for each separate compartment shall be provided and duly interlocked with the breaker in "ON" and "OFF" position.
- Protection Microprocessor based releases and/or thermal magnetic releases shall be provided for the Circuit Breakers as stipulated in the Schedule of Quantities

- Electrical endurance Upton 250 amps minimum 10,000 operations
- For 400 amps & above minimum 4,000 operations
- Type test certificates Submit Certificates from a recognized test house for the Circuit Breakers offered. Other specification as per BOQ.

1.4.5.2. Switchboard

- Supply System Three phase 4 wire, 415-volt, 50 Hz, Indian TN-S system.
- Short circuit level withstands as per Schedule of Quantities.
- Ingress protection IP 42 as applicable.
- Metal based neoprene gaskets between all adjacent units and beneath all doors and covers shall be provided to render the joints dust and vermin proof.
- Pressure relief devices shall be provided to minimize danger to operator during internal fault conditions.

Panel Compartmentation

- Compartment Tier 3A as per IEC 6043 (Part-I) unless otherwise stated in Schedule of Quantities.
- Circuit Breaker Metering Separate segregated compartment shall be provided for accommodating instruments, indicating lamps, control contactors and control MCB etc. These shall be accessible for testing and maintenance without any danger of accidental contact with live parts of the circuit breaker, bus bars and connections.
- Control wiring compartment a horizontal wire way with screwed cover shall be provided at the top to take interconnecting control wiring between vertical sections.

Panel Configuration

- Panel configuration - MCCB's arranged multi-tier formation.
- Air Circuit Breakers - Single or double tier formation.
- Spare Space provision - The Switchboards shall have a provision of 25% spare space to accommodate possible future additional switch gear.
- Extensible shall be extensible on both sides.

Panel Construction

- Metal clad totally enclosed,
- Dead front

- Floor mounted
- Free standing type
- Modular extensible design
- Suitable for indoor mounting.

Switchboard cubicles, doors and covers - Fabrication with CRCA Sheet Steel

Cubicles - Thickness shall be 3.0 mm for load bearing compartments and 2.0 mm for non-load bearing compartments, folded and braced to ensure rigid support for all components.

Doors/ covers - Thickness not less than 1.6 mm & should be properly

earthed. Joints - Seam welded

Welding slag - Ground off

Welding pits - Wiped smooth with plumber metal.

Switchboard frames Fabrication

With electro galvanized MS sheets 'U' Channel switchboard frames of 2.5 mm thick

All joints should be neatly formed and finished flush with adjacent surfaces, No joints shall be located in corners. Bare edges shall be round/covered.

Structural members and bracings where ever required shall be welded or bolted to the frame. The frame shall be of modular design and extensible.

Cable compartment Rear Access switchboards

All cabling from rear, Front access switchboard, Separate vertical cable accessible from front only. Adequate space shall be provided for ease of installation and maintenance with safety for working without coming into contact with any live parts.

The cable chambers shall be complete with

- Adequate support for cables.
- Tinned brass cable sockets,
- Tinned brass compression glands,
- 3 mm thick gland plates,
- Supporting clamps and brackets etc. for termination of 1,100-volt grade aluminum conductor XLPE cables.
- Door handles Good quality door handles fitted with toggles to operate rods to latch with suitable slots

in both top and bottom of switchboards shall be provided. Latching rods and associated brackets shall be cadmium plated.

- Operating handles all operating device shall be located in front of switchgear only.
- Fixing Screws Fixing screws shall enter holes tapped into an adequate thickness of metal or provided with hank nuts. Self-threading screws shall not be used in switchboards.
- Dimensional Limitations
 - i. Base channel 75 mm x 5 mm thick shall be provided at the bottom.
 - ii. Minimum 200 mm blank space between the floor of switchboard and bottom most unit shall be provided.
 - iii. Overall height shall be limited to 2,300 mm unless otherwise stipulated.
 - iv. Height of the operating handle, push buttons etc. shall be restricted between 300 mm and 1,700 mm from finished floor level.

Switchboard Bus Bars, Interconnections etc. rating

- Rating of Bus Bars, interconnections and to feeders these shall be designed as per requirements in Schedule of Quantities to Carry full load current for phase and neutral bus bars Withstand the stresses of fault level. For aluminum & copper current density shall be of minimum cross section of 0.6 & 1.0 amp per sq. mm respectively.

Switchboard Bus Bars

- Bus Bar material High conductivity, high strength aluminum alloy, complying with requirements of grade E 91E of IS 5082 – 1981
Alternatively, Electrical grade 99.99% pure copper as per Schedule of Quantities
- Bus Bar Insulation Heat shrunk PVC sleeving of 1.1 kV grade and bus bar joints provided with clip-on shrouds.
- Bus Bar supports Non-breakable, non-hygroscopic epoxy resin or glass fiber reinforced polymer insulated supports able to withstand operating temperature of - 25°C to 130°C (degree of protection IP 65 IEC 60529) at regular intervals, to withstand the forces arising from a fault level as stipulated in schedule of quantities.
- Colour coding all bus bars shall be colour coded.
- Auxiliary Bus Electrolytic Copper Auxiliary buses for control power supply, space heater power supply or any other specified service shall be provided. These shall be insulated, adequately supported and sized to suit specific requirement.

Switchboard Interconnections

- Interconnection material Unit ratings up to 100 amps,
- FRLS PVC insulated copper conductor wires with crimped terminations.
- Rating of 100 amps and above solid copper/aluminum connections PVC sleeved
- Interconnection jointing all connections, tapings etc.
- Shall be made to ensure minimum contact resistance.
- Shall be firmly bolted and clamped with even tension before assembly.
- Joint surfaces shall be filed or finished to remove burrs, dents and oxides and Silvered to maintain good continuity at all joints.

All screws, bolts, washers shall be cadmium plated.

Approved spring washers shall be used with cadmium plated high tensile steel bolts with BSF threads.

- Instrument and control wiring all wiring for relays and meters shall be with ZHFR PVC insulated copper conductor wires. The wiring shall be coded and labelled with approved ferrules for identification. All power circuit wiring shall be minimum 2.5 sqmm and control circuit wiring shall be of minimum 1.5 sqmm and for CT & PT minimum 4sqmm copper cable shall be considered. Other specification as per BOQ.

Earthing

Continuous earth bus sized for prospective fault current shall be provided with arrangement for connecting to station earth at two points. Hinged doors / frames shall be connected to earth through adequately sized flexible braids.

Space Heaters

Anti- condensation heaters shall be fitted in each cubicle together with an ON/OFF isolating switch suitable for electrical operation at 230 volts A.C 50 Hz single phase of sufficient capacity to raise the internal ambient temperature by 5°C operation interlocked with switchgear.

- Sheet Steel Treatment and Painting Sheet steel used in the fabrication of switchboards shall undergo ar rigorous cleaning and surface treatment seven tank process comprising of alkaline degreasing, descaling in dilute Sulphur acid and a recognized phosphating process after which a coat of primer paint comp actively with the final paint shall be applied over the treated surface. Final paint coat of oven baked powder coating, of minimum 50-micron thickness, of sheet approved by Engineer-in-Charge shall then be provided.
- Labels Suitable engraved white on black metal identification labels shall be provided for each

switchgear cubicle in front and back identifying the circuit, switchgear type, rating and duty.

Testing at manufacturers works

Following testing must be completed before dispatch of equipment at site, if required Engineer-In-Charge may call for factory inspection to ensure all testing are completed.

- All wiring checks and connections
- Relay adjustment
- Interlock function check
- Continuity checks of wiring, fuses
- Insulation resistance test
- Trip test
- High voltage test
- Testing and commissioning
- Assembly of various sections of panels
- Grounding the units
- Bus bar termination on switchgear
- Insulation test with 500 volts megger. The insulation resistance should be more than 100mega ohms
- Local Authority Requirements. All requirements by the local Authority including those listed below shall be complied with
- Provision for Gas nozzles within each cubicle
- Danger Notice Plate
- Rubber floor mat of minimum 6 mm thickness and 1 m width provided for the full length of the switchboard.
- A dry chemical type fire extinguisher of required capacity with approved label . Other specifications per BOQ.

1.4.5.3. Relays, CTs, PTs, Meters, Indicating Lamps etc.

General

This section covers specifications for Protection and Control Relays for breakers, Instrument Transformers, Measuring Instruments, Push Buttons, and Indicating Lamps etc. required in LT and HT switchboards.

Standards and codes

Updated and current Indian Standard Specifications and Codes of Practice will apply to the equipment and the work covered by the scope of this contract. In addition, the relevant clauses of the Indian Electricity Act 2003, Indian Electricity Rules 1956, National Building Code 2016, National Electrical Code (SP30 : 2011), Code of Practice for Fire Safety of Building (general): General Principal and Fire Grading – IS 1641 as amended up to date shall also apply. Wherever appropriate Indian Standards are not available, relevant British and/or IEC Standards shall be applicable.

| | |
|--|-----------|
| Application guide for Current Transformers | IS 2705 |
| Application guide for Voltage Transformers | IS 3156 |
| Instrument Transformers (Current & Voltage Transformers) | IEC 61869 |
| Application guide for Relays | IS 3842 |
| Electromagnetic Relays | IS 5051 |
| Microprocessor Relays | IEC 60255 |

1.4.5.4. **Protection and control relays**

The Circuit Breaker shall have protection and control relays as specified in the bill of quantities. Relays shall be approved types complying to relevant ISS and having approved characteristic. Relays shall be flush mounted in dust proof cases. Relays shall be arranged so that adjustments, testing and replacement can be affected with minimum of time and labour.

In case of C.T. operated thermal overload and magnetic instantaneous short circuit release. The overload releases shall be such that each phase can be individually set depending on the phase unbalanced currents. The releases shall have inverse time current characteristics and the magnetic release shall be time delayed with a minimum setting of 25 ms varying up to 300 ms for discrimination without effecting the breaking current capacity of the ACB.

1.4.5.5. **Current transformer**

Separate sets of CTs shall be provided for metering and protection. C/Ts shall conform to IS 2705 (part -I, II and III) in all respects. All C/Ts used for medium voltage application shall be rated for 1.1 kV. C/Ts shall have rated primary current, rated burden and class of accuracy as specified in Bill of Quantities/drawings. Rated secondary current shall be 5A unless otherwise stated. Minimum acceptable class for measurement shall be class 0.5 and for protection class 5P10. C/Ts shall be capable of withstanding magnetic and thermal stresses due to short circuit faults on the bus. Terminals of C/Ts shall be paired permanently for easy identification of poles. C/Ts shall be provided with earthing terminals for earthing chassis, frame work and fixed part of metal casing (if any). Each C/T shall be provided with rating plate indicating:

- i. Name and make
- ii. Serial number
- iii. Transformation ratio
- iv. Rated burden
- v. Rated voltage
- vi. Accuracy class

CTs shall be mounded such that they are easily accessible for inspection, maintenance and replacement. Wiring for CT shall be with copper conductor FRLS PVC insulated wires with proper termination works and wiring shall be bunched with cable straps and fixed to the panel structure in a neat manner.

1.4.5.6. Potential transformer

PTs shall conform to IS 3156 (Part-I, II and III) in all respects.

1.4.5.7. Measuring instruments

Direct reading electrical instruments shall conform to IS 1248 or in all respects. Accuracy of direct reading shall be 1.0 of voltmeter and 0.5 for ammeters. Meters shall be suitable for continuous operation between -5 degree C and +50 degree C above ambient temperature. Meters shall be flush mounting and shall be enclosed in dust tight housing. The housing shall be of steel or phenolic mold. Design and manufacture of meters shall ensure prevention of fogging of instrument glass. Pointer shall be black in colour and shall have Zero position adjustment device operable from outside. Direction of deflection shall be from left to right. Suitable selector switches shall be provided for ammeters and volt meters used in three phase system. The rating type and quantity of meters, instruments and protective device shall be as per Schedule of Quantities /drawings.

Ammeters

Ammeters shall be of moving iron type. Moving part assembly shall be with jewel bearings. Jewel bearings shall be mounted on a spring to prevent damage to pivot due to vibrations and shocks. Ammeters shall be manufacture and calibrated as per IS 1248.

Ammeters shall normally be suitable for 5 A secondary of current transformers. Ammeters shall be capable of carrying substantial over loads during fault conditions.

Voltmeters

Voltmeters shall be moving iron type range of 3 phase 415-volt voltmeters shall be 0-500. Volt meters shall be provided with protection fuse.

Watt meter

Wattmeter shall be of 3 phase electro dynamic type and shall be provided with a maximum demand indicator if required.

Power factor meter

3 phase power factor meters shall be of electro dynamic type with current and potential coils suitable for operation with current and potential transformers provided in the panel. Scale shall be calibrated for 50% lag - 100% - 50% readings. Phase angle accuracy shall be +40.

Energy and reactive power meters

Trajectory meters shall be two elements, integrating type, kWh, kVA, kVArh meters. Meters shall confirm to IEC 170 in all respects. Energy meters, kVA, and kVArh meters shall be provided with integrating registers. The registers shall be able to record energy consumption of 500 hours corresponding to maximum current at rated voltage and unity power factor. Meters shall be suitable for operation with current and potential transformers available in the panel.

1.4.5.8. Indicating lamps

Neon type indicating lamps shall be provided for indication of phases and Breaker position as required in the bill of quantities. Lamps shall be easily removed and replaced from the front of the panel by manual means not requiring the use of extractors.

1.4.5.9. Push buttons

Push buttons shall be of non-hygroscopic material, non-swelling and fitted to avoid any possibility of sticking. Contacts shall be of adequate strength and have a positive whipping action when in operation.

1.4.5.10. Battery and Battery Charger

General

This section covers specifications for lead acid batteries and float cum boost battery chargers. DC is considered as unearthed system. Other specification as per BOQ.

Standards and codes

Updated and current Indian Standard Specifications and Codes of Practice will apply to the equipment and the work covered by the scope of this contract. In addition, the relevant clauses of the Indian Electricity Act 2003, Indian Electricity Rules 1956, National Building Code 2016, National Electrical Code (SP30 : 2011), Code of Practice for Fire Safety of Building (general): General Principal and Fire Grading – IS 1641 as amended up to date shall also apply. Wherever appropriate Indian Standards are not available, relevant British and/or IEC Standards shall be applicable.

| | |
|--|--------------------|
| Electrical vocabulary secondary cells and batteries | IS 1885 |
| Lead Acid SMF VRLA Batteries | JIS C8702 |
| Stationary valve regulated lead acid | IS 15549:2005 |
| Water for storage batteries | IS 1069 |
| Sulfuric Acid for storage batteries | IS 266 |
| General requirements for tests for lead acid storage batteries | IS 8320 |
| Rubber and Plastic containers for batteries | IS 1146 |
| Synthetic Separators | IS 6071 |
| High performance planet cells | BS 6290 (Part II) |
| IE recommendations for sizing of large lead acid storage batteries | IEEE 485 |
| Design and installation of storage batteries | IEEE 484 |
| Stationary lead acid batteries | IEC – 896 (Part I) |

Battery

The battery shall be sealed maintenance free / valve regulated lead acid (SMF/VRLA) battery. The batteries shall be manufactured using “absorbent glass matt” technology in which the electrolyte is in absorb condition, held within the pores of the glass matt separator. The separator is packed tightly between the positive and negative plates. “Lead Calcium Tin Alloy” shall be used in the plate grid structure to eliminate harmful effect of early gassing. The container and the lid of the battery shall be of high-grade polypropylene. The vent plugs shall be provided with self-resealing relief valves. The battery shall be rated for minimum 100 AH at 24-volt DC unearthed system. The battery sizing calculation to be carried out by vendor during detailed engineering stage and to be submitted to Electrical consultant for verification and approval.

Battery Charger

General

The battery charger shall be float cum boost type, thermistors controlled. The charger shall have selector switch for auto float – boost/manual, float /manual boost mode of operation. During auto float

– boost mode, automatic changeover shall take place from float mode to boost mode and vice versa. This means that when the batteries are fully charged the charging shall automatically change from boost charge to trickle charge.

Construction feature

The float cum boost charger and DC distribution board shall be housed in sheet steel cubicle of angle iron frame work with panels of 2.0 mm thickness, louvers for ventilation, glands plate will be provided for cable entry from front bottom. The cubicle shall be painted in siemens grey shade. Four wheels/2 nose channels shall be provided at the base.

Performance

The DC output voltage of float /boost charger shall be stabilized within $\pm 2\%$ for AC. Input variation of 230 V $\pm 10\%$, frequency variation of 50 Hz $\pm 5\%$ and DC load variation of 0-100%. The voltage regulation shall be achieved by a constant voltage regulator having fast response IGBT. The ripple content in output will be within 3% of DC output nominal voltage.

There shall be provision to select auto float/manual float /manual boost modes. During auto float mode the battery charging shall automatically changeover from boost mode to flat mode and vice versa. During manual float/boost modes it shall be possible to set the output volts by separate potentiometers. The battery charger shall have automatic output current limiting feature.

Components

The battery charger shall essentially comprise of the following

- 1 no. double pole ON/OFF MCB at AC input
- 1 no. pilot lamp to indicate charger ON.
- 1 no. main transformer: Double wound, naturally air cooled, having copper windings.
- 1 no. rotary switch to select auto float / manual float / manual boost. During auto float mode automatic changeover shall take place from float mode to boost mode and vice versa.
- 1 set solid state constant potential controller to stabilize the DC output voltage of the float cum boostcharger at $\pm 2\%$ of the set value for AC input voltage variation of 230 V $\pm 10\%$, frequency variation of $\pm 5\%$ from 50 Hz and simultaneous load variation of 0-100% and also complete with current limiting circuit to drop the float charger output voltage upon overloads to enable the battery to take over.
- 1 no. electronic controller to automatically changeover battery charging from boost to float and vice versa 1 no. DC ammeter and toggle switch to read charger output current and battery charge/discharge current.
- 1 no. moving coil DC voltmeter to read the DC output voltage.
- 2 set potentiometers to adjust the output voltage during manual/auto float and boost modes.

- 1 no. double pole ON/OFF MCB at charger output. DC distribution board.
- Alarm annunciation

Visual and audible alarm with manual accept/ reset facility shall be provided for the following:

- AC mains fail
- Charger fails
- Load / output over volt
- Potential free contact for BMS connectivity for maintaining battery status.

1.4.6. Technical Specification of 11KV 200Amp. (3-Pole/2-Pole) Air Break Switch

1.4.6.1. Scope

This specification covers manufacturing, testing and supply of 11KV 200Amp. 50Hz Air Break switches for outdoor installation in horizontal configuration. The switches are suitable for operation under off-load conditions only and are intended for use on Distribution Sub-stations and tapping sectionalizing points of 11 KV lines.

1.4.6.2. Description of the materials

The 11KV A.B. Switch sets shall confirm to the following parameters: -

- | | |
|--------------------------------------|--------------------------|
| a) Number of poles | 3 |
| b) Number of Post insulator per pole | 2nos. 12KVpostinsulator. |
| c) Nominal system voltage | 11KV |
| d) Highest system voltage | 12KV |
| e) Rated frequency | 50Hz |
| f) System earthing | effectively earthed. |
| g) Rated nominal current | 200 amps |
| h) Altitude of installation | Not exceeding 1000M |

The post insulators used in the A.B. Switches shall have the following ratings:-

- | | |
|--|-------------|
| a) Power frequency withstand voltage (dry) | 25KV (RMS) |
| b) Power frequency withstand voltage (wet) | 35KV (RMS). |
| c) Implies withstand voltage(dry) | 75KV |
| d) Power frequency puncture withstand | 1.3 |

1.4.6.3. Standards

The AB Switch Set shall conform to the following standards: -

- i) IS-9920 (Part-I to V)
- j) IS-2544/1973 (for porcelain post insulators)
- k) IS-2633, (for galvanization of ferrous parts.) or its latest amendments if any.

1.4.6.4. Insulator make

12KV post insulators complete with post and cap duly cemented to be used in the AB Switch Set conforming to IS-2544/1973.

The bidder shall furnish the type test certificate of the post insulators from their manufacturer for reference and scrutiny.

The bidder shall mention make, type of insulation materials, metal fittings, Creepage distance, protected Creepage distance, tensile Strength, compressing strength, torsion strength and cantilever strength.

1.4.6.5. Climatic condition

The A.B. Switch set shall be suitable for operation under the following climatic conditions.

| | |
|---|----------|
| Maximum ambient air temperature | 45 °C |
| Maximum daily average air temperature | 35 °C |
| Maximum yearly average ambient air temperature | 30 °C |
| Maximum temperature attainably by a body exposed to the Sun | 50 °C |
| Minimum ambient air temperature | 0 °C |
| Maximum relative humidity | 100% |
| Minimum number of rainy days per annum | 70 |
| Average number of rainy days per annum | 120 |
| Average annual rainfall | 150 cm |
| Number of months of tropical monsoon conditions | 4 |
| Degree of exposure to atmospheric pollution | Normally |
| Atmosphere. | Polluted |

1.4.6.6. Other technical details

- General: - The 11KV A.B. Switch Set shall be the gang operated rotating single air break type having 2 post insulators per phase. The operating mechanism shall be suitable for manual operation from the ground level and shall be so designed that all the three phases shall open or close simultaneously. The Switches shall be robust in construction, easy in operation and shall be protected against over travel or staining that might adversely affect any of its parts. The required base M.S. Channel (hot dip galvanized) phase coupling rod, operation rod with intermediate guide braided with flexible electrolytic copper, tail piece of required current carrying capacity and operation mechanism with "ON" & "OFF" positions shall be provided. The operation rod shall be medium gauge of 32mm diameter nominal bore G.I. pipe single length 6 meters. The phase coupling rod for gang operation shall be of medium gauge 25 mm dia. nominal bore G.I pipe. The Rating post insulators shall be provide with suitable bearing mounted on a base channel with 8mm dia thrust collar and 6mm split pin made out of stainless steel. The operating down rod shall be coupled to the spindle (minimum) dia – 32mm for gang operation through another suitable bearing by two numbers 10mm dia stainless steel bolts with double nuts. All the bearings shall be provided with grease nipple. All metal (ferrous) parts shall be galvanized a polished. The pipe shall be galvanized in accordance with IS-4736/1968. The post insulators should be fixed with the base channel using Galvanized Nuts and Bolts.
- Mounting: - The A.B. Switches shall be suitable for horizontal mounting in double pole sub-station structures. MS Galvanized base Channel & base support channel should be of min. size 75x40x6 mm.
- Switching Blades: - It shall be made out of electrolytic copper with silver plated. The approximate size shall be 220mm X 50X 6 mm. The Switch shall have such a spring mechanism so as to ensure that the speed of the opening of contact is independent of speed of manual operation.
- Fixed Contracts: - The fixed Jaw type female contracts shall be made of electrolytic copper (minimum 95% copper composition) duly silver coated controlled by stainless steel high pressure spring housed in robust G.I. Cover. It is essential that provision shall be made in fixed female contracts to take the shock arising from the closing of move contract blade without the same being transmitted to the post insulator. The arrangement made in this regard shall be specifically shown in the drawing.
- Arcing Horn: - As the switches are generally meant for isolating transmission line and distribution transformers, suitable arcing horns shall be provided for breaking the charging

current horn shall be made of 10mm dia. G.I. Rod with spring assisted operation.

- Terminal Connectors: - Terminal connectors shall be robust in design. The size of fixed connector shall be (80 X 50 X 6 mm) and size of movable connector shall be of (80 X 50) X (80 X 50) X 6 mm of copper casting with uniform machine finishing duly silver plated made out of minimum 95% copper composition with 2 nos. 12mm dia holes provided with suitable brass bolts and double nuts, flat washers & 2nos. bimetallic solder less sockets suitable upto 80 mm² conductor.
- Spacing: - The minimum clearance between phases to the switch shall be 760mm. The operation down rod shall be at a transverse distance of 300mm from the outer limb of the switch. The centre spacing between two post insulators of the same phase shall be 380mm. In the open position of the A.B. switches the moving blade shall rotate through 90°. This shall be exhibited in the drawing.
- Sample, Drawing & Literatures: - Sample of each item 11KV 200 amps. A.B. Switch shall be furnished and three copies of drawings item similar to the sample shall be furnished along with the tender.
- The details of construction and materials of different parts of the A.B. Switch shall clearly be indicate in the tender and illustrative pamphlet / literature for the same shall be submitted along with the tender.

1.4.6.7. Test & Test Certificate

- Type Test: - Certificate for the following type tests conducted (within five years proceeding to the date of opening of the tender) on a prototype set of A.B. Switch in a NABL approved test house/CPRI shall have to be submitted along with offer.
- Dielectric Test (impulse and one minute were power frequency withstand voltage test.)
 - i. Temperature rise test (for contracts and terminals)
 - ii. Shorts Time current and peak withstand current test.
 - iii. Mainly active load breaking capacity test.
 - iv. Transformer off-load breaking capacity test.
 - v. Line charging breaking capacity test.
 - vi. Cable charging breaking test.
 - vii. Operation and mechanical endurance test.
 - viii. Mechanical strength test for post insulator, as per IS-2444/1937 shall be furnished.
 - ix. Test for galvanization of metal (ferrous) parts.

1.4.6.8. Routine /Acceptance Test

The inspection may be carried out by the Purchaser at any stage of manufacture. The successful bidder shall grant free access to the Purchaser's representative at a reasonable time when the work is in progress. The following routine tests shall have to be conducted on each set and results are to be furnished for consideration of deputed inspecting officer for inspection and conduction testing of the materials at the works of the manufacturer. The supplier shall give fifteen days advance intimation to the Purchaser to enable him to depute his representative for witnessing the tests.

- a. Power frequency voltage dry test.
- b. Measurement of resistance of main circuit.
- c. Tests to prove satisfactory operation.
- d. Dimension Check
- e. Galvanization test.
- f. Operational test.

1.4.6.9. Guaranteed Technical Particulars

The bidder shall furnish the guaranteed technical particular duly filled in the format along with the tender.

1.4.6.10. Completeness of Equipment

All fittings, accessories of apparatus which may not have been specifically mentioned in this specification but which are usual or necessary in equipment of similar plant shall be deemed to be included in the specification and shall be supplied by the Tender without extra charge. All plant and equipment shall be completed in all details whether such details are mentioned in the specification or not.

1.4.7. Technical Specifications for Transformer

This specification is intended to cover design manufacture assembly, testing at manufacturer's works, supply and delivery of three phases, 50 Hz, 11/0.433 kV Delta/Star, Vector Group Dyn11 two windings copper wound outdoor type oil immersed naturally air-cooled Transformer is per detail furnished here after.

The transformer offered be complete with all parts and accessories which are necessary or usual for their efficient and satisfactory operation. Such parts and accessories be deemed to be within the scope of this specification whether specifically mentioned or not.

Main tank body may be delivered in unpacked condition, but delicate parts like indicating meter, radiator, and conservator. Pressure Relief Valve, equalizer pipe, be packed to avoid damage due to transport, shipment. The equipment and work conform to General Specifications for electrical works of CPWD (Part- I, II, IV) as amended up to date, BSI /IEC and relevant Indian Electricity rules, Indian Electricity Act 2003 and other relevant regulations with statutory regulation and safety codes that is related to the work.

Location

The equipment supplied be suitable for satisfactory performance for the rated capacity at all weather conditions in summer, monsoon, and winter at Sambalpur, Odisha as under:

-

- (a) Altitude: less than 1,000 mtr.
- (b) Max. ambient air temp: 50°C
- (c) Max. daily average ambient air temp: 40°C
- (d) Max. yearly weighted average ambient temp: 32°C
- (e) Min. yearly weighted average ambient temp: -5°C
- (f) Temp. rise at the above conditions:
- (g) By resistance method: 55°C (Max. temp. being 95°C)
- (h) By Thermometer: 50°
- (i) By Maximum Humidity: 79%
- (j) Seismic Zone: III

System details

11 kV system is Non- Effectively Earthed, whereas 433 V Systems is to the Effectively Earthed at Neutral Point of the Star Connected Windings of the Transformer.

Applicable standards

Unless otherwise stated, transformer be designed, constructed, and tested in accordance with provisions contained in latest revisions of following Indian standards and Rule

- IS 1180 (part 1): 2014 (Level 2)
- REC Manual 10/1976.
- C B.I.P Manual on Transformer Technical Report 1: Section A.D: (Revised: 1987)
- C.B.I.P Technical Report No 72 (June 1989)
- C.B.I.P Publication 295 - 2007

- Indian Electricity Rules, 1953 (Amended up to date)
- other applicable Indian Standards.

Deviations from specifications

The deviations from the purchaser’s specification to improve utility, performance and efficiency of equipment or to secure overall economy be considered if such deviations(s) is (are) mentioned by the Tenderer in the “Schedule of Deviations” with full justification.

Rating and general particulars Type

Core Type, Three Phase. Oil immersed step-down two winding copper wound transformer for outdoor installation.

Standard Rating

Off Circuit Tap Changer as Mentioned in the Schedule of Quantities.

Continuous Maximum Rating and Temperature rise

As regards maximum rating and temperature rise, all transformers comply with the appropriate requirement of Indian Standards

To consideration of maximum temperature rise of oil and winding the following ambient temperature are assumed.

- Cooling medium : Air
- Maximum Ambient Air temperature : 50°C
- Maximum daily average ambient Air temperature : 40°C
- Maximum yearly weighted average temperature : 32°C.

With the Above Ambient Temperature Condition Allowable Maximum Temperature Rise be As Mentioned Below

| Type of Cooling | Oil in °C | Winding in °C |
|-----------------|-----------|---------------|
| ONAN | 40 | 45 |

No load voltage ratio

The No Load Voltage Ratio Corresponding to Principal (Normal) Tapping be 11000/433 Volts Winding Connections and Vector Group etc.

- i. Number of phases : Three

- ii. Frequency : 50 HZ
- iii Type of Cooling : ONAN
- iv. Winding connections : The primary winding (HV) be connected in delta and secondary winding (LV) be connected in star.
- v. Vector Group : Windings be connected as per Vector symbol Dyn11 of Indian Standards to produce a punitive displacement of 30 Deg. from the primary to the secondary vectors of the same phase assuming vector rotation counterclockwise.
- vi. Neutral Earthing : The neutral point of the secondary (LV) winding be brought out to a separate insulated terminal and he solidly earthed.

Taps

Transformer be provided with off load taps ranging from +5% to -10% in steps of 2.5% each on H.V winding for H.V. variation. The tap changing switch be in a convenient position so that it can he Operated from Ground level. The Control Box be provided with Tap Position Indication & Locking Arrangement.

Technical Specification of Off Load Tap Changer to be supplied with 200 kVA 11kV/433 V Transformer

- The Off-load tap changer be designed suitable for local manual as well as local electrical operation
- An oil immersed tap selector and arching switch or are suppressing tap selector, provided with reactor or resistor for reduction of make and break arcing voltages and short circuits
- Control and protection devices.
- Manual/Electrical operating device.

A suitable pressure reliving arrangement should be provided to take care to sudden pressure rise in compartment.

The manual operating device be so located on transformer that it can be operated by a man standing at the level of transformer track. It is strong and robust in construction.

Impedance Value

The percentage impedance be as follows

| S No. | Rating | Voltage Ratio | % Impedance |
|-------|---------|---------------|------------------------------|
| 1. | 200 kVA | 11 kV/433 V | 4.5 or as per manufacturer's |

DataThe impedance value refers to the (normal) principal tapping are subject to a tolerance of $\pm 10\%$

Terminal

Cable Box on HV & LV Sides for Cable Termination

Short circuit level

Designed maximum fault level of 11 kV and 21 kA for 3sec or as per IS

Insulation level

Insulation Level be as per IS

Cores

The Cores be constructed from high grade cold rolled non-aging grain-oriented silicon steel laminations having magnate coating as insulation. The core thickness shall be 27 microns

Successful bidder will offer the Core for inspection and/or approval by the purchaser during the manufacturing stage. Manufacturer's Call notice for the purpose should be accompanied with the following as applicable as a proof towards use of Prime Core materials:

- i. Invoice of supplier
- ii. Mill's Test Certificate
- iii. Packing Lists
- iv. Bill of Lading
- v. Bill of entry Certificate to Customs

Core materials be procured either from the core manufacturer or through their accredited marketing organization of repute.

Tendered should preferably have in-house Core cutting facility for proper monitoring and Control on quality.

The materials used for insulation have high interred lamination resistance and rust inhibiting property. It not deteriorates by aging from hottest operating temperature and clamping pressure of the core or disintegrate due to core vibration. It not has any tendency to absorb moisture or to react with insulating oil.

The assembled core be securely clamped on the limbs and yoke with uniform pressure to minimize noise emission from it.

The top main core clamping structure be connected to the tank body by a copper strip. The bottom clamping structure be earthed by one or more of the following methods (i) by connecting through vertical tie rods to the top structure (ii) by direct metal to metal contact with the tank base by the weight of the core and winding (iii) by a connection to the top structure on the same side of core as the main earth connection to the tank.

All parts of the cores be robust design capable of withstanding any shock, to which they may be subjected during lifting, transport, installation, and service.

Adequate lifting lugs be provided to enable the core and winding to be lifted.

Adequate provision be made to prevent movement of the core and winding relative to the tank during transport and installation or while in service.

The supporting framework of the cores be so designed as to avoid the presence of pockets which would prevent complete emptying of the tank through the drain valve or cause trapping of air during filling.

The insulation structure for the core to bolts and core to clamp plates be such as to withstand a voltage of 2000 V AC at 50HZ for one minute.

Flux density of core

Flux Density at rated voltage and frequency shall not exceed 1.69 tesla or as per latest Indian Standards.

The No load current shall not exceed 1.5 % of the full load current. The no load current shall not exceed 3 % of the full load current in L. V. Winding when the applied voltage is 112.5%

Winding

- All windings shall be electrolytic copper (99.9% purity) be fully insulated.
- Transformer be designed to withstand the impulse and power frequency test voltages
- The windings be designed to reduce to a minimum the out of balance forces in the transformer at all voltage ratios.
- The insulation of transformer winding and connections be free from insulating material liable to soften, ooze out, shrink or collapse and be non-catalytic and chemically inactive to transformer oil during service.
- The stacks of windings receive adequate shrinkage treatment before final assembly.

- Adjustable device be provided for taking up any possible shrinkage of coils in service.
- All the insulating material to be used in the transformer preferably be of class - A insulation as specified in Indian Standards, the test certificate of the materials be made available by the transformer manufacturer on request during inspection and testing
 - The coil clamping arrangement and the finished dimensions of any oil ducts be such that it will not impede the free circulation of oil through the ducts.
 - The windings and connections of transformer be braced to withstand shocks which may occur during transport or due to switching short circuit and other transient conditions during service.
 - Coil clamping rings, if provided, be of steel or suitable insulating material. Axially laminated material other than Bakelite paper not be used.

Inter earthing arrangements:

General:

All metal parts of the transformer except for the individual core laminations, core bolts and associated individual clamping plates be maintained at fixed potential.

Earthing of core clamping structure:

Core clamping structure be earthed as specified in clamping section above.

Earthing of coil clamping rings:

Where coil clamping rings are of metal at earth potential each ring be connected to the adjacent core clamping structure on the same side of transformer as the main earth connection.

The Total number of earth electrodes shall be 4 (2 for neutral and 2 for connection to a common earth bus for body earthing) in two different places

Tanks

Tank Pressure be as per Manufacturer Standard and comply the latest IS Standard

Construction:

The Transformer tank and cover be fabricated from good commercial grade low carbon steel suitable for welding and of adequate thickness. The tanks of all transformers be complete

with all accessories and be designed so as to allow the complete transformer in the tank and filled with oil, to be lifted by crane or jacks, transported by- rail, road without overstraining any joint and without causing subsequent leakage of oil.

The main tank body be capable of withstanding vacuum gauge pressure 68 kN/sq. m (500 mm. of Hg). The under carriage of the tank be made of channel of suitable size and design.

The base of each tank be so designed that it be possible to move the complete transformer unit by skidding in any direction without injury when using plate or rails. Where the base is at a channel construction. It be designed to prevent retention of water.

Tank stiffeners be deigned to prevent retention of water. Wherever possible the transformer tank and its accessories be designed without pockets wherein gas may accumulate. Where pockets cannot be avoided, pipes be provided to vent the gas into the main expansion pipe

All joints other than those which may have to be broken be welded when required they be double welded. All bolted joints to the tank be fitted with suitable oil tight gaskets which give satisfactory service under the operating conditions and guaranteed temperature rise conditions. Special attention be given to the methods of making hot oil tight joints between the tank and the cover as also between the cover and busing and all other outlets to ensure that the joints can be remade at site satisfactorily.

Tank cover

Each tank cover be of adequate strength and not distort when lifted. Inspection openings be provided as necessary to give easy access to bushings or changing ratio or testing the earth connection. Each inspection opening be of ample size for the purpose for which it is provided.

The tank cover and inspection cover be provided with suitable lifting arrangement.

The tank cover be fitted with pockets for thermometer and for the bulbs of oil and winding temperature indicators. The thermometer pocket be fitted with a captive screwed top to prevent the ingress of water. Protection be provided, where necessary for each capillary tube. The pocket be in the position of maximum oil temperature and it be possible to remove the instrument bulbs without lowering the oil in the tank. Turrets should provide on tank cover to house the bushing. The tuners of both HV & LV bushings should be connected through pipes with main tank pipe to drive out trapped air or should have air release plug to drive outtrapped air.

Conservator vessels

The conservator should be normal type to prevent direct contact of Transformer oil with atmospheric air for retarding oxidation and contamination of oil. The air cell be made from

suitable material with inner coating resistant to transformer oil & outer coating resistant to ozone & weathering.

The conservator be provided with necessary valves to drive out the air in the space between conservator wall & air cell during filling of oil drain valves for complete draining of oil and cut off valves etc.

The conservator completes with necessary valves be provided in such a position as not to obstruct the electrical connections to the transformer from H.V & LV. SIDE.

The conservator to have a capacity to meet the requirement of expansion of the total cold oil volume in the Transformer & cooling equipment.

The conservator be designed so that it can drain oil completely by means of the drain valve provided when mounted. One end of the conservator be bolted into position so that it can be removed for cleaning purpose.

Oil Gauges

Normally one Magnetic type oil gauge be provided. The oil level at 30°C be marked on the gauge

Connection

The oil connection from the transformer tank to the conservator vessel be arranged at a raising angle of 3° to 9° to the horizontal and consist of pipe with inside diameter 50 mm/80 mm as per capacity of the transformer and as per IS : 3639. Two valves be provided between the conservator and transformer main tank to cut off the oil supply to the transformer after providing a straight run of pipe for at least a length of five times the internal diameter of the pipe on the tank side of the gas and oil actuated relay and at least three times the internal diameter of the pipe on the conservator side of the gas and oil actuated relay. The valves should be fitted on both sides of the Gas and Oil actuated Relay.

Breather

Conservator vessel be fitted with a glass container type breather in which silica gel is dehydrating agent and so designed that:

- i. The passage of air through the silica gel
- ii. The external atmosphere is not continuously in contact with the silica gel
- iii. The moisture absorption indicated by a change in colour of the tinted crystals can

be easily observed from the distance.

- iv. breather be mounted at approximately 1400 mm above ground level and be connected to the air cell of the conservator through pipe for the purpose of breathing during contraction or expansion of the air cell

Bushings

Pollution free type insulator should be used for the bushings. The bushing should be located on suitable turrets (with air release plugs). Adjustable arcing horns should be provided on the Bushings; Bushings of identical voltage rating be interchangeable. All bushings be equipped with suitable terminals of approved type size and be suitable for bimetallic connections

The bushings have high factor of safety against leakage to ground and so located as to provide adequate electrical clearance between bushing and grounded parts.

Both HV & LV Bushing should be suitable for use in heavily polluted atmosphere as per IS 2099 & IS 3347. 3 Nos. H.V Bushings & 4 Nos. L.V. Bushing should be supplied with the transformer.

Filter, drain valves, sampling devices and air release plugs

Each transformer be fitted with the following

- A drain valves as specified below be fitted to each conservator for diameter up to 650 mm: Size of the valve 15 mm: for diameter above 650 mm: Size of the valve 25 mm.
- Suitable oil sampling device be provided at the top and bottom of the main tank. This sampling device is not fitted on the filter valves specified under (ii) above
- One 15 mm air release plug on the main tank of the transformer
- All other valves opening to atmosphere be fitted with blank flanges.

Radiator

General

Radiators be so designed as to avoid pockets in which moisture may collect and withstand the pressure tests. The radiator tubes / fins be seamless, made of mild steel having minimum wall thickness of approx. 1.0 mm and a clean bright internal surface free from dust and scale. They be suitably braced to protect them from mechanical shocks, normally met in transportation and to damp the modes of vibration transmitted by the active part of the transformer in service. Each cooler unit have a lifting eye.

The butterfly or similar metal valves be provided for isolating detachable radiator assembly.

One cock each at the bottom of radiator stack be provided for draining oil from radiator stacks.

Air release plug each at the top of radiator stack be provided for release of locked air from radiator stack. Removable blanking plates be provided to permit the blanking off main oil connection of each cooler. Radiator fixing bands in top & bottom of radiators to be provided to minimize the vibration of the same.

Lifting and haulage facilities

Each tank be provided with

- (i) Lifting lugs suitable for lifting of transformer complete with oil.
 - a. A minimum of four jacking lugs, in accessible positions to enable the transformer to complete with oil to be raised or lowered using hydraulic or screw jacks. The minimum height of the lugs above the base
 - b. Transformer up to and including 10 tonnes weight -300 mm.
 - c. Transformer above 10 tonnes weight – 500 mm
- (ii) Suitable haulage holes be provided

Insulating oil

The transformer and all associated oil filled equipment be supplied complete with insulating new oil required for first filling including 10% extra oil for future use during commissioning. The transformer tank be dispatched filled oil and the balance oil be supplied in non-returnable sealed drums along with the Transformers.

The insulating oil conform to the requirement of IS: 335: 1993.

Pressure relief device

Pressure relief device be provided with A/T Contact of sufficient sizes for rapid release of any pressure that may be generated within the tank, and which might result in damage to the equipment. The device operates at a static pressure of less than the hydraulic test pressure for transformer tank. Means be provided to prevent ingress of rain. It shall be mounted on the cover of the main tank and be designed to prevent gas accumulation. Spring loaded setting type Pressure Relief Valve having suitable opening Port hole according to the capacity of the Transformers should be provided. The Pressure Relief Valve should have provision of visual indication for opening of the valve.

Axis and wheels

The Transformer be provided with flanged bidirectional wheels as mentioned below

Transformer rating in kVA Type Flanged wheel suitable for use on a 1,435 mm / 1676 mm gauge track.

The wheels be suitable for being turned through an angle of 90°C and locked in that position when the tank is jacked up. All wheels be detachable and be made of Cast iron or Steel. Suitable locking arrangement be provided to prevent the accidental movement of the transformer.

Painting

Before painting or filling with oil all metallic parts be completely cleaned and free from rust, scale and grease and all external surface cavities on castings be filed by metal deposition

The interior of al transformer tank and other oil filled chambers and internal structure steel work be thoroughly cleaned of all scale and rust by sand blasting or other approved method. These surfaces be painted with hot Oil resisting varnish or paint. Unexposed weld need not be painted.

Except for nuts, bolts, and washers, which may have to be removed for maintenance purposes all external surface receives a minimum of three coats of paint.

The primary coat be applied immediately after cleaning. The second coat be of oil paint of weather resisting nature and preferably of a shade or colour easily distinguishable from the primary and final coats be applied after the primary coats have been touched up where necessary. The final coat be of a glossy oil and weather resisting non-fading paint of Dark Admiralty Grey shade no. 632 of IS:5. Primer paint be ready-made zinc chrome as per IS: 104: intermediate and final costs of paint be as per IS: 2932.

All interior surfaces of mechanism chambers and kiosks except those which have received anti-corrosion treatment receive three coats of paint applied to the thoroughly cleaned metal surface as per procedure mentioned above. The final coat be of a light-coloured anti-condensation mixture.

Any damage to paint work incurred during delivery be made good by the manufacturer by thoroughly cleaning the damage portion and applying the full number of coats of paint that had been applied before the damage caused.

Earthing terminal

Two earthing terminals capable of carrying the full amount of lower voltage short circuit current of transformer continuously for a period of 5 second provisions be made at positions close to each of the bottom two corners of the tank for bolting the earthing terminals to the tank structure to suit local conditions.

Temperature indicating devices

Oil temperature indicator with one electrical contact be provided with anti-vibration mounting. The oil temperature indicator be housed in the marring box.

The winding temperature indicator with two electrical contacts for alarm and trip purposes be provided with anti-vibration mounting. The winding temperature indicator be housed in the marring box.

The oil and winding temperature indicator should be of renowned make preferably of "Perfect Control". The scale on the dial of the thermometer should be 0°C to 150°C. The angular displacement of thermometer should be 270.

The tripping contracts of indicator be adjustable to close the winding temperature indicator between 60°C and 120°C. The alarm contacts of indicator be adjustable to close between 30°C & 50°C.

All contacts be adjustable on a scale and be accessible on removal of the cover. The Temperature indicators be so designed that it shall be possible to check the operation of contacts and associated equipment.

For measuring winding temperature, a heater coil fed from a C.T. (Current transformer) must be provided on the pocket for winding temperature indicator bulb. The connection from C.T. to heater should be through a link arrangement on tank cover suitably housed in a weatherproof box so that C.T. current and heated coil resistance can be checked.

Rating diagram

The following plates shall be fixed to the transformer tank at a suitable height so that the particulars could be read by standing at ground level.

- A rating plate bearing the date specified in the relevant clause of IS: 2026 including figures of temperature rise of oil and winding and high voltage test values.
- A diagram plate showing the internal numbering of taps, tapping switch connection of windings and the voltages vector relationship in accordance with IS:2026 and in addition a plan view of the transformer giving the correct physical relationship of the terminals. No load voltage be indicated for each tap. the losses should be mentioned with impedances

The centre of gravity

The centre of gravity of the assembled transformer shall be low and as near the vertical centre line as possible. The transformer shall be stable with or without oil. If the centre of gravity is eccentric relative to track either with or without oil, its location shall be shown on the outline

drawing

Operation

The transformer shall be suitable for operating in Board's Sub independently or in parallel with one or more transformers.

Duty under fault conditions

It is to be assumed that normal voltage will be maintained on one side of the transformer when there is a short circuit between phases or to earth on the other side.

The transformer may be directly connected to an underground or overhead line and may be switched into and out of service together with or without its associated incoming / outgoing line.

The thermal ability to withstand short circuit be 21kA for 3 sec without injury for 3 phase dead short circuit at the terminal.

Rated voltage of operating device

Rated voltage for indicating and operative device be 24 volts DC /230 volts AC with variations as specified in the relevant IS.

Foundation

The Contractor shall furnish foundation plan of the transformer showing the fixing arrangement of the transformer so that the purchase may be able to finalize the foundation drawing.

Tests and inspection Routing Test

All transformer shall be subjected to the following routing tests at the manufacturers work.

The test be carried out in accordance with the details specified in IS: 1180 Part 1 (Level 2)

- i. Measurement of winding resistance
- ii. Measurement of voltage ratio and check of polarity, voltage vector relationship
- iii. Measurement of impedance voltage / short circuit impedance
- iv. Measurement of load loss
- v. Measurement of no-load loss and no-load current

- vi. Measurement of insulation resistance.
- vii No Load and Load Losses
- viii Impedance Voltage
- ix. Induced over voltage withstand test.
- x. Separate source voltage withstands test.
- xi. Heat Run Test/Temperature rise test (Test not to be Conducted, Only calculation Certificate Should be Provided By Manufacturers)

- xii Measurement of unbalance current and magnetizing current test at 110% rated voltage and frequency
- xiii Testing of neutral CT in accordance with provisions in the relevant IS.
- xiv Oil BDV Test
- xv HV Test
- xvi Insulation Test
- xvii Continuity Test

Type and special tests.

In addition to routine tests mentioned above the transformer shall be subjected to all kinds of type and acceptance tests in accordance with relevant ISS (IS: 2026)

If type tests have successfully been carried out earlier in compliance with the provisions made in the relevant IS from a recognized institution then the copy of the same in triplicate be furnished along with the tender papers in respect of each of kind of transformer.

If Type tests have not yet been carried out, then the manufacturer have to do so at their own cost. Owner if feels, may depute their representative to witness the said Type Tests etc. The manufacturer arranges all facilities for such inspection and tests free of cost.

Inspection and testing

Inspection & Testing as already mentioned the equipment be subjected to routine and other acceptance tests as per provisions in the relevant IS.

The Engineer-In-Charge reserves the right to send its Engineers if so desires to witness manufacturing process and to reject either raw materials or finished products found to be not complying with the requirement of the specification and also have the right to select any/all equipment from the lot offered for tests.

The manufacturer shall give at least (21) twenty-one days' advance notice regarding readiness of such inspection and testing and submit six set of the works test certificates of the material / equipment offered for inspection and testing indicating probable date of inspection and testing.

The supplier shall arrange all possible facilities for such inspection and testing at any time during manufacture free of cost.

Test certificates

Seven copies of the approved Test certificates as mentioned above are to be furnished to the Owner before dispatch of the equipment.

Drawing and manuals

The following drawings and details shall be furnished in triplicate along with the tender:

- i. General Arrangement outline drawing with plan, elevation and end views showing various dimensions of transformer and its vital component including height of the bottom most portion of bushing from the bottom of base channel and also indicating thereon physical center line and position of center of gravity.
- ii. Three copies of sketches for height of crane hook above ground for lifting and undertaking core, shipping dimensions, complete lists of fittings and devices, net weights of core, winding, tank, radiator, oil, conservator and total weight, fixing arrangement of transformer in foundation.
- iii. Installation, operation, and maintenance manual.
- iv. The following drawings and manuals in six sets shall be submitted for approval within 15 (fifteen) days from date of placement of LOI / ORDER.
 - i. Cross sectional details with plan, elevation and views showing all internal clearances.
 - ii. Drawing of Name & rating plate
 - iii. Drawing of diagram
 - iv. Installation, operation and maintenance manual of transformer, associated equipment like temperature indication, oil level indicator etc.

The manual clearly indicates the installation method, check-ups and tests to be carried out before and after commissioning of the transformer.

Guaranteed technical particulars:

Tenderers shall furnish guaranteed technical particulars of equipment offered as per Schedule 'B' Performance Guarantee shall be based on guaranteed technical particulars.

Short circuit calculations

Manufacturer shall submit theoretical calculations in support of the ability to withstand short circuit on consideration of highest value that may attain in triplicate within 15 (fifteen) days from the date of placement of L.O.I./Order.

Performance certificates

Copies of performance certificates of similar Equipment supplied to various organizations

have to be furnished along with Tender

Credentials

Tenderer shall furnish documents in support, delivery, of similar equipment indicating thereon names of the organization quantity ordered, quality supplied along with tender.

Deviations

All deviations from the specifications shall be recorded in the "Deviation Sheet" with reference to respective clauses of the Specification by drawing Specification for the same. Unless deviations are recorded in the Deviation Sheet and submitted with the offer, it will be taken for granted that the offer is made in conformity with Specification.

Spare parts

The Contractor shall submit a recommended list of spare parts for five years of operation along with item wise price for each item of spares.

Validity period

Validity period of the offer be reckoned from the date of opening of tender provided it is technically and commercially complete one. Otherwise, it will be counted from the date of receipt of complete information.

Transformer fitting & accessories /Spares

All screw threads and nuts shall be made as per ISS and all valves shall be of standard tested quality and leak proof.

The following fittings and accessories shall be supplied with each transformer

1. Outdoor type bushing – HV-3 Nos. and LV-4 Nos.
2. Normal Type Conservator
3. Conservator drain valve
4. Dial type oil level indicator complete with alarm contact.
5. Silicate breather with oil seal and connecting pipe. The breath shall be accessible for inspection from ground.
6. Access / inspection holes with bolted cover for access to inner ends of bushing
7. Cover lifting eyes
8. Lifting eyes for core frame with windings
9. Off load tap changing arrangement

10. Air release plugs on top of cover and hushing turrets.
11. Upper filter valve and bottom filter valve.
12. Drain valve
13. Top and bottom oil sampling devices. Provision for oil sample collection during process of filtration should be made.
14. Lifting lugs
15. Jacking pads with handling holes at four corners.
16. Transport lugs.
17. Undercarriage base channel.
18. Tank earthing terminal - 2 Nos
19. Dial thermometer for winding temperature with alarm contacts and trip contacts.
20. Dial thermometer for oil temperature with alarm contacts.
21. An additional pocket for inseting thermometer for oil temperature indication
22. Weatherproof control cabinet for Marshalling terminal connections from protective and indicative devices. The cabinet be provided with incandescent filament lighting, plugs tic.
23. Neutral C.T. in LV side of Power Transformer.
24. Rating plate as per ISS
25. Diagram Plate
26. LT cable box with extended bus bar for terminations

1.4.8. Technical Specifications for UPS

(Nominal output active power at PF=1) True Online UPS having IGBT based rectifier & with Inbuilt Isolation Transformer compatible for parallel redundant configuration designed for having no single point of failure even for communication. UPS should be CE marked, 3 Phase 415V (+10% -15%), 50 Hertz $\pm 10\%$ input & 3 phase 415V, 50Hz output with selection for 380/400/415V AC. UPSs operating in parallel redundancy load need to share load equally during normal mode and also to be capable of handling Electronic short-circuit protection, current limit to: 2.7 times I_n for 200 ms between phase and phase and 4.0 times I_n for 200 ms between phase and N/PE and also overload of 125% for 10 Mins & that of 150% for 1 min. IGBT Based rectifier should be capable of restricting input current harmonics (THDi) to $< 3\%$ and maintaining the Input power factor ≥ 0.99 above 25% of load . Scalability

should be feasible & for that each UPS should have its own built in static bypass as well as manual bypass arrangement. Static switch should be fully rated for continuous duty & whereas built in manual bypass should be of make before break type.

AHMI comprising of LCD features of web-enabled Monitoring and Management through SNMP protocols for multi-OS environments should be integral part of the UPS.

| | | |
|----------------|--|----------------------------|
| | General | |
| | Scope | |
| | These specifications describe requirements for an Uninterruptible Power System (UPS) consisting of single modules UPS units connected in parallel, redundant mode/stand alone with manual bypass switch. The UPS shall automatically maintain AC power within specified tolerance to the critical load, without interruption, during failure or deterioration of the mains power supply. Each UPS shall be complete with 12-plus operation IGBT based PWM design inverter and IGBT based charger, built-in-static bypass switches and built in communication ports and LCD display based keypads. Each unit shall be designed for three phase and neutral input and output. The UPS shall be expandable by paralleling additional modules of the same rating, to provide for module redundancy or load growth requirements. It shall include all equipment to properly interface the AC power sources to the intended load and be designed for unattended operation. | |
| 1.2 | Technical specification | |
| Sl. No. | Description | Parameters required |
| 1 | Capacity | As per BOQ |
| 2 | Environment Characteristics | |
| 2.1 | Working temperature | 0° to 40° C (Continuous) |
| 2.2 | Storage temperature | -10 ° to 50 ° C |
| 2.3 | Humidity | 95% non-condensing |
| 2.4 | Standards | EN50091-2/IEC 62040-2 |
| 3 | General Characteristics | |
| 3.1 | Overall Efficiency of the UPS under following conditions: | |

| | | |
|-----|---|---|
| a) | Lowest input Volts to Highest Input Volts | Not less than 90% under specified conditions |
| b) | Lowest Input Frequency to Highest Input Volts | |
| c) | AC/AC total efficiency @ 75% load | |
| d) | AC/AC total efficiency @ 100% load | |
| 3.2 | Noise level @ 1 Mtr. distance | < 70db |
| 3.3 | Conversion technology | True-Online & Double conversion |
| 3.4 | Configuration | Compatible to Single, Parallel, Dual Bus arrangement. |
| 3.5 | No. of systems that can be paralleled | 3 or more |
| 4 | Input Electrical Characteristics | |
| 4.1 | Type of rectifier | SCR Based –Power Factor Corrected |
| 4.2 | Input Voltage (3 phase) | 360-460V |
| 4.3 | Input Frequency | 50 Hz to $\pm 1\%$ |
| 4.4 | Input Power factor @ 50 to 100% load | 0.98 or better |
| 4.5 | Input voltage band | 360 to 460 V |
| 4.6 | Input Current harmonic distortion (THD) | Less than 3% |
| 5.1 | | IGBT based PWM design |
| 5.2 | Output Voltage (3 phase) | 380V/400V/415V (user selectable) |
| 5.3 | Output waveform | Sinusoidal |
| 5.4 | Static output voltage variation underfollowing conditions | $\pm 1\%$ |
| a) | No load to Full load/full load to No load | |
| b) | 0.5 lag to unity p.f | |
| c) | Minimum to Maximum DC input volts | |

| | | |
|----------|--|--|
| d) | Input Frequency from 46 to 54 Hz | |
| e) | Full Input Voltage range | |
| 5.5 | Output Voltage variation | |
| a) | At balance load | $\pm 1\%$ |
| b) | At 100% load step (Dynamic Regulation) | $\pm 1\%$ |
| 5.6 | Voltage adjustment- Manual | Required |
| 5.7 | Output frequency | 50Hz |
| 5.8 | Frequency regulation | $\pm 0.2\%$ |
| 5.9 | THD at Output | $\leq 2\%$ for liner load & $\leq 5\%$ for non- linear load. |
| 5.10 | Phase displacement (a) in balance load | $120^\circ, \pm 1\%$ |
| 5.11 | (b) in 100% unbalanced load | $120^\circ, \pm 2\%$ |
| 5.12 | Overload capacity | |
| | At 110% | For 60 minutes |
| | At 125% | For 10 minutes |
| | At 150% | For 1 minutes |
| 5.13 | Crest Factor | 3:1 |
| 5.14 | Voltage Transient Recovery Time | ≤ 20 ms |
| 6 | Static bypass arrangement | To be provided |
| 7 | Battery details | |
| 7.1 | Type of batteries | SMF battery |
| 7.2 | Back-up | 30 minutes |
| 7.3 | AH of the battery | By Vendor |
| 7.4 | Life of battery | > 3 years |
| 7.5 | Battery temperature sensor | By Vendor |

| | | |
|-----------|--|-----------------------------------|
| 7.6 | No. of Batteries provided | By Vendor |
| 7.7 | Battery Monitoring in YPS | By Vendor |
| 7.8 | Battery mounting | By Vendor |
| 7.9 | Dimensions of battery cabinet (LXBXH) | By Vendor |
| 7.10 | Weight of battery cabinet | By Vendor |
| 7.11 | Base Frames for UPS & battery racks | By Vendor |
| 8 | Communication | |
| 8.1 | BMS compatibility | Required |
| 8.2 | SNMP | Required |
| 8.3 | Fast Events & Trend Analysis | Required |
| 8.4 | Life Cycle Monitoring of Fans, DC/AC Capacitors, Batteries | Required |
| 9 | Charger | |
| 9.1 | Type | SMPS |
| 9.2 | Nominal Voltage Regulation | ±1% |
| 9.3 | Ripple (without batteries) | <1% |
| 9.4 | Charging Method | Constant Voltage Constant Current |
| | | |
| 10 | General: | |
| | Indicate the make, capacity & other technical characteristics of the devices used. | |
| | Input reverse phase sequence protection is to be provided. UPS should work on main mode in case of input reverse phase sequence. | |
| | Built in Galvanic Isolation (Neutral Isolation) through double-wound transformer at output. | |

- e) **Off-Battery-** If the battery system only is taken out of service for maintenance, it is disconnected from the rectifier/charger and inverters by means of (an) external disconnect breaker(s). The UPS shall continue to function and meet all of the specified steady-state performance criteria, except for the power outage back-up time Capability.
- f) **SNMP (Simple Network Management Protocol)** - Web enabled Adopter card with smart software for server shutdown shall be Provided by UPS vendor.
- g) **Parallel Operation** All the UPS shall work in synchronization mode & share the entire load equally by each UPS. In case of failure of any UPS the same, shall be disconnected automatically from the system and the load shall be transferred to the other healthy UPSs equally and there should be no interruption of supply during this transferring operation.

Maintenance Free Battery Requirements

Battery banks connected to different KVA UPS shall be designed to provide 30 minutes back-up at full load. The UPS module should be automatically disconnected when the battery reaches to the minimum discharge voltage level or when signaled by other control functions.

During normal operation batteries shall be continuously float charged & the charging current is electronically controlled for the limiting purpose.

UPS Delivery submittals

The specified UPS shall be supplied with one (a) user manual to include details of

- a) Functional description of the equipment with block diagrams.

- b) Detailed installation drawings, including all terminal locations for power and control connections for both the UPS and battery system.
- c) Safety precautions.
- d) Step-by-step operating procedures
- e) General maintenance guidelines
- f) The UPS & Battery's shall be supplied with a record of pre-shipment final factory test report. & Certificate shall be provided by manufacturer

Construction and Mounting

The UPS unit comprised of Input Isolator, Rectifier/Charger, Inverter, Static transfer switch, Maintenance Bypass switch and static bypass input switch shall be housed in a free-standing steel enclosure with key lockable doors. Front/rear access shall be required for expedient servicing, adjustments and installation. The enclosure will be built to comply with IP 20. The UPS shall be constructed of replaceable sub-assemblies. Printed circuit assemblies shall be plug-in type.

Cooling

Cooling of the UPS shall be by forced air ventilation. Low velocity fan shall be used to minimize audible noise output. Fan power shall be provided by the UPS output. Temperature shall be monitored by thermal sensors.

Cable Entry.

Standard cable entry for the UPS module shall be from the bottom/top as required through detachable gland plate.

Static Transfer Switch

General

Static transfer switches and bypass circuit shall be provided as an integral part of the UPS. The static switch shall be naturally commutated high-speed static (SCR type) devices rated to conduct full load current continuously and shall have naturally commutated high-speed static antiparallel SCR's in the output of the inverter circuit as well as in the static bypass line to enable the critical load to be connected to the inverter output or bypass power sources. The static transfer switch control logic shall contain an automatic transfer control circuit that Senses the status of the inverter logic signals, and operating and alarm conditions.

This control circuit shall provide an uninterrupted transfer of the load to an alternate bypass sources, without exceeding the transient limits specified herein, when an overload or malfunction occurs within the UPS, or for bypassing the UPS for maintenance.

The Static bypass switch must automatically assume the critical load to mains supply without interruption after logic senses one of the following conditions:-

- | Inverter overload beyond
- | Battery run time expired and bypass available
- | Inverter failure
- | Battery circuit breaker open
- | Fatal error in control system.

The short circuit withstanding capability of static Bypass path should be 1430% for 20 millisecond & 1000% for 5 cycles (1000 millisecs)

Uninterrupted Transfer

The transfer control logic shall automatically turn on the static transfer switch, transferring the critical ac load to the bypass sources, after the transfer logic senses any of the following conditions.

- | Inverter overload capacity exceeded

- | Critical AC load over voltage or under –voltage.
- | UPS fault condition.

The transfer control logic shall inhibit and automatic transfer of the critical load to the bypass sources if any of the following conditions are present.

Uninterrupted Retransfer

Retransfer of the critical AC load from the bypass sources to the inverter output shall be automatically initiated unless inhibited by manual control. The transfer control logic shall inhibit an automatic retransfer of the critical load to the inverter if one of the following conditions exists:

- | Bypass out of synchronization range with inverter output
- | Inverter/bypass voltage different exceeding pre-set limits.
- | Overload condition exists in excess of inverter full load rating
- | UPS fault conditions present.

Maintenance Bypass Isolator

General

A manually operated maintenance bypass isolator shall be incorporated into the UPS cabinet to directly connect the critical load to the input AC power sources, bypassing the rectifier/charger, inverter and static transfer switch.

Maintenances Capability

Without the critical load powered from the maintenance bypass circuit, it shall be possible to checkout the operation of the rectifier/charger, inverter, battery and static transfer switch.

Display and Controls

Monitory & controlling – The UPS shall be provided with a microprocessor-based unit status display & controls section designed for convenient and reliable user operation. A system power flow diagram, a percentage load and battery time remaining display shall be provided as part the monitoring and controls sections which depict a single-line diagram of the UPS illuminated visual indicators. Shall be of long life LED type. All of the operator controls and monitors shall be located on the front of the UPS cabinets

The following parameters shall be displayed.

Display Parameter

- | DC Voltage
- | Battery voltage
- | Battery charger & discharge current
- | Input voltage and frequency
- | Output AC voltage line-to-line and line to neutral and 1% load used of nominal
- | Output frequency
- | Active Power (KW) Apparent Power (KVA)
- | Temperature- Ambient, battery, inverter and transformer

Warning and Alarm Messages

- | Normal Operation, Input breaker open
- | Output breaker open
- | Battery breaker open
- | Bypass absent, Bypass over limits.
- | Bypass under limits, Bypass freq. over limit
- | Bypass inhibit
- | Load on bypass
- | Rectifier off or failed

- | Inverter off or failed
- | UPS unsynchronized
- | D.C. Volts over voltage
- | D.C. under voltage and end of discharge pre-alarm
- | DC Bus over volts Battery Low
- | Emergency stop
- | UPS Overload

Controls

Four pushbuttons shall be located on the operator control panel.

- | Enter
- | Escape
- | UP
- | Down

The push buttons shall permit the operator either to select options from a menu for display on the LCD winder or to change the value of some parameters. One push button –alarm silence switch

1.4.9. Technical Specifications for Computer Jack RJ 45

RJ45 Jack of Category 6, for the establishing of transmission channels of class E with up to 4 plugged connections, complies with Category 6 requirements of the standards ISO/IEC 11801:2nd edition, EN 50173-1, DIN EN 50173-1: 2002 as well as ANSI/TIA/EIA 568-B.2-1, de-embedded tested in acc. with IEC 60603-7 (603-7), interoperable and backwards compatible with Cat.5e and Cat.5. Suitable for 10GBase-T applications in acc. with IEEE 802.3an up to 500 MHz and 55 m. Compatible with RJ standard plugs (RJ11, RJ12, RJ45), PCB- and tool based connection of installation cables AWG 24 – 22 (0.5 mm – 0.65 mm) and flexible cables AWG 26/7 – AWG 22/7. IDC termination should feature nil crossover in acc. with EIA/TIA 568-A/B, gold-plated bronze contacts for >750 mating cycles, >200 insertion cycle

Material: RoHS complied

Housing material: Polycarbonate (UL-94-V0)

Should be available with or without dust protection feature

Should be 3P certified

1.4.10. Technical Specifications for CCTV

Technical Specification of Dome/Bullet Camera

| S.No | Features | Specifications |
|------|----------------------|---|
| 1 | Form Factor | DOME/BULLET |
| 2 | Certification | UL,CE,FCC |
| 3 | Housing | IP67 and IK10 or better |
| 4 | System Compatibility | ONVIF profile S ,G & T |
| 5 | Max Resolution | 5MP(2592 X 1944) |
| 6 | lens | 2.7mm to 12 mm motorized varifocal length |
| 7 | Focus | Auto focus |
| 8 | Image sensor | 1/2.8" or larger |
| 9 | H-FOV | 99 ~ 30° |
| 10 | Min illumination | 0.01 Lux @ (F1.2,AGC ON), 0 Lux with IR |
| 11 | Shutter speed | 1/5 s ~ 1 / 100,000 s |
| 12 | Video compression | H.265+ ,H.265 ,H.264+ H.264 |
| 13 | Video bit rate | 256 Kbps to 8 Mbps |
| 14 | Noise reduction | 2D / 3D DNR |
| 15 | Video Streams | Quad stream , Each stream should support H.265+ compression |

| | | |
|----|--------------------|---|
| 16 | IP filter | Should support IP filter for security purpose |
| 17 | Frame rate | Main stream upto 5MP@25fps , sub stream upto 2MP@25fps , third and fourth stream upto VGA@25fps |
| 18 | ROI | Should Support ROI for Better bandwidth consumption |
| 19 | BLC | Support |
| 20 | Day & Night | IR cut filter with auto switch |
| 21 | Day / Night Switch | Auto / Schedule / Triggered by Alarm In |
| 22 | Edge analytics | Motion Detection, Perimeter Intrusion, Line Crossing, Stationary Object, Pedestrian detection, Face detection (deep learning) , Cross counting |
| 23 | Image setting | Flip, Rotation, Corridor mode, Saturation, Brightness, Contrast, Hue, Sharpness adjustable |
| 24 | Rotate Mode | Yes |
| 25 | WDR | 120 dB WDR |
| 26 | Alarm | 1 input, 1 output |
| 27 | Audio | 1 input, 1 output |
| 28 | SD Card support | upto 128 GB |
| 29 | Protocols | TCP/IP, HTTP, DHCP, DNS, DDNS, RTP/RTSP, PPPoE, SMTP, NTP, UPnP, SNMP, HTTPS, FTP, |
| 30 | Video output | 1 X BNC |
| 31 | Reset button | Available |
| 32 | Security | Flash-prevention, dual stream, heartbeat, password protection, privacy mask, IP address filtering |
| 33 | Digital Zoom | Should have the capability to digitally zoomed in web browser by selecting the area using mouse |
| 34 | Factory Default | Should have the option of setting the configuration to factory default except network settings. |
| 35 | Privacy Zones | Min 4 Nos of selectable privacy Zones |
| 36 | User accounts | Should support 1 admin and 6 user accounts |
| 37 | Firmware upgrade | Firmware upgrade shall be done through web browser |
| 38 | Remote Update | Camera IP and firmware should be upgradable through the device search tool/Software without directly logging in to the camera. Firmware should also be upgradable through web browser |
| 39 | Defog | Should support Defog mode |
| 40 | IR Distance | Min IR distance 40 meters |

| | | |
|----|-----------------------|---|
| 41 | Vandal resistant | IK10 |
| 42 | Operating Temperature | -30°C ~ 60°C Humidity 95% or less (non-condensing) |
| 43 | General | OEM should not be blacklisted nationally or internationally |

Note: All other specifications shall be as per BOQ/Manufacturer's specifications

Technical Specification of 32 Channel NVR

| S.No | Features | Descriptions |
|------|------------------------------|--|
| 1 | Channels | 32 IP Cameras |
| 2 | Certifications | UL,CE,FCC |
| 3 | Compatibility | ONVIF profile S & G |
| 4 | Power Supply | Power adaptor must be supplied with NVR |
| 5 | Smart Phone Support | iOS, Android |
| 6 | Remote Viewing & Monitoring | Smart phone and Desktop client software |
| 7 | Recording Bandwidth | Max 320Mbps |
| 8 | Recording Mode Supportable | Normal , Motion , Alarm |
| 9 | Instant play back | Supported |
| 10 | Email | E-mail alert on video loss |
| 11 | Firmware Upgrade | Firmware upgrade through USB/web browser |
| 12 | Compression Support | H.265 , H.264 |
| 13 | HDD | Support 2 SATA HDD , Each HDD capacity of upto 8 TB |
| 14 | Users | Support 6 user accounts and one admin |
| 15 | Digital Zoom on live view | Support digital Zoom on live view |
| 16 | Digital zoom on playback | Support digital zoom on playback |
| 17 | PTZ Support | Support PTZ Cameras with Pan , tilt and Zoom functionality |
| 18 | Analytics | Edge analytics of proposed cameras should be integrated with NVR . |
| 19 | Recording Resolution | 8MP (4K), 5MP, 3MP ,2MP(1080P), 1.3MP (960P), 1.0MP (720P) |
| 20 | Recording backup USB | Support recording download by directly connecting USB pen drive to NVR |
| 21 | Recording backup web browser | Support downloading of recording through web browser on workstation/PC . |
| 22 | Display Split | 1/4/6/8/9/10/13/14/16 |
| 23 | Output Interface | 1 HDMI (up to 4K), 1 VGA |

| | | |
|----|--------------------|--|
| 24 | Display Resolution | 1024*768,1280*720,1280*1024,1440*900, 1920*1080,1680*1050,1600*1200,1900*1200, 2560*1440,3840*2160 |
| 25 | Alarm Input/out | 16ch in / 1ch out |
| 26 | Ethernet | RJ-45 port (1000M) |
| 27 | RS485 | supported |
| 28 | Line In | yes |
| 29 | USB | 1x3.0 USB for backup/ upgrade,2x 2.0 USB for mouse |

Technical Specification of 24 Port PoE Switch

| S.No | Features | Specifications |
|------|--------------------------|--|
| 1 | Port Configuration | 24 Nos of 10M/100M/1G RJ45 Port ,4 Nos of1G/10GSFP+ Port , 1 Nos of DB9 Console Port . |
| 2 | PoE Function | IEEE802.3at (PoE+ 30W) ,IEEE802.3af (PoE 15.4W) |
| 3 | PoE Port | 24 |
| 4 | Available PoE Power | 370W |
| 5 | Switching Bandwidth | 128 Gbps |
| 6 | Forwarding Performance | 95.232 Mpps |
| 7 | MAC Address | 32 K |
| 8 | Jumbo Frames | 10056 Bytes |
| 9 | Spanning Tree | IEEE802.1D (STP),IEEE802.1W (RSTP),IEEE802.1S (MSTP) |
| 10 | VLAN | 802.1Q VLAN , Port-Based ,Private VLAN , Voice VLAN ,Guest VLAN, Q-in-Q , 802.1v Protocol VLAN ,MAC-Based VLAN ,IP Subnet-Based VLAN |
| | | 4K VLAN Entries |
| 11 | IEEE 802.3ad LACP | Dynamic Trunk , Static Trunk |
| 12 | | GARP/GVRP , IGMP Snooping , MLD Snooping, Multicast VLAN Registration (MVR) |
| 16 | L3 Features | Static Route , DHCP Server |
| 17 | Class of Service | Port Based , 802.1p ,DSCP, TCP/UDP Port |
| 18 | Rate Limiting | Ingress , Egress |
| 19 | Priority QueueScheduling | WRR , Strict Priority |
| 20 | Hardware Queues | 8 |
| 21 | ACLs | L2/L3/L4 , IPv6 Support |

| | | |
|----|-----------------------------|--|
| 22 | Security | Port Security (MAC-based) , IP Source Guard ,Storm Control ,RADIUS Authentication 802.1x , TACACS+ Authentication ,HTTPs and SSL (Secured Web) ,BPDU Guard ,STP Root Guard ,DHCP Snooping, Loop Protection |
| 23 | DHCP | Client , Relay , Option 66 , Option 67 , Option 82 |
| 24 | Event/Error Log | Syslog , SMTP (RFC821) |
| 25 | Management Access Filtering | SNMP , Web , Telnet , SSH |
| 26 | PoE Management | Scheduling ,Auto-Checking ,Power Delay |
| 27 | | SNMP (v1, v2c, v3) , RMON (1,2,3 & 9 Groups), Software Upgrade |
| 28 | | Configuration Export/Import , Port Mirroring , |
| 29 | | LLDP (IEEE802.1AB) |
| 30 | | LLDP-MED (IEEE802.1AB) |
| 31 | | CDP Aware ,sFlow ,IPv6 Management , NTP |
| 32 | Device Management | Topology View , Floor View ,Map View , Dashboard ,Traffic Monitoring , Cable Diagnostics |
| 33 | Operating Temperature | 0°C to 40°C |
| 34 | Operating Humidity | 10 to 90% RH |
| 35 | Storage Temperature | -20 to 70°C |
| 36 | Storage Humidity | 10 to 90% RH |
| 37 | AC Input | 100V-240V |
| 38 | Certifications | EN61000-4-5 (for RJ45 Port, Surge 6KV) ,CE/FCC Class A |

1.4.11. Technical Specifications for Octagonal Pole

This specification is intended to cover design manufacture assembly, testing at manufacturer's works, supply and delivery of Octagonal Poles as per ISO 9001, ISO 14001 and OSHAS 18001 certified factory taking care of all aspects of design, quality, environment and safety. The Contractor should ensure that manufacturer of Octagonal Poles must have minimum 12 years of manufacturing experience.

The poles have to be manufactured by CNC Controlled plasma sheet cutting and bending machine and fully Automated Submerged arc welding machine for longitudinal welding of shaft and welding to be carried out by experienced and certified welders.

Pole should be tested as per BSEN 40-2-1 & 3 for steel test and test certificate shall be submitted showing silicon content less than 0.04%.

Poles, bracket, foundation bolts, and fixture should be of one make. Test certificate of steel manufacturer and Pole manufacturer specifying grade of steel used for Poles.

The Octagonal Poles shall be designed to withstand the maximum wind speed as per IS 875. The toploading i.e. area and the weight of fixtures are to be considered to calculate maximum deflection of the pole and the same shall meet the requirement of BSEN 40-2- 1 & 3.

Pole Shaft - The pole shaft shall be made from sheet steel confirming to BSEN 10025 having yield strength of 355 N/sqmm and silicon content less than 0.04%. The pole shaft shall have octagonal cross section and shall be continuously tapered with single longitudinal welding. There shall not be any circumferential welding. The welding of pole shaft shall be done by Submerged Arc Welding (SAW) process.

Octagonal pole shafts shall be provided with the rigid flange plate manufacture from MS FE410 confirming to IS: 2062 of suitable thickness with provision for fixing 4 foundation bolts. This base plate shall be fillet welded to the pole shaft at two locations i.e. from inside and outside. The welding shall be done as per qualified MMAW process approved by Third Party Inspection agency.

Door opening: The octagonal Poles shall have door of approximate 500 mm length at the elevation of 500 mm from the Base plate. The door shall be vandal resistance and shall be weather proof to ensure safety of inside connections. The door shall be flush with the exterior surface and shall have suitable locking arrangement. There shall also be suitable arrangement for the purpose of earthing.

The pole shall be adequately strengthened at the location of the door to compensate for the loss in section.

Welding: The welding shall be carried out confirming to approve procedures duly qualified by third party inspection agency. The welders shall also be qualified for welding the octagonal shafts.

Pole sections: The Octagonal Poles shall be in single section (up to 12 Mtrs). There shall not be any circumferential weld joint.

Galvanization: The poles shall be hot dip galvanized as per BSEN ISO 1461 standard with average coating thickness of 70 microns. The galvanizing shall be done in single dipping.

Fixing Type: The Octagonal Poles shall be bolted on a pre-cast foundation with a set of four foundation bolts for greater rigidity.

Top Mountings: The galvanized mounting bracket shall be supplied along with the Octagonal Poles for installation of the luminaries.

Pole Testing Facility: The Manufacturing unit shall have in house pole testing facility for validation for structure design data. The Pole testing facility shall be as per BSEN 40 – 2 1 & 3. It is to be noted that updated and current Standards shall be applicable irrespective of those listed below

| | |
|-----------|---|
| IEC 60146 | Semiconductor converters |
| IS 13947 | Low voltage switchgear and control gear |
| IS 8623 | Low voltage switchgear and control gear assembliesIEC |
| 60529 | Degree of protection provided by enclosure |
| IS 4540 | Mono crystalline semiconductor rectifier assemblies and equipmentIS |
| 3136 | Polycrystalline semiconductor rectifier equipment |
| IS 2147 | Degree of protection provided by enclosure for low voltageIEC |
| 60747 | Semiconductors devices |
| IEC 62485 | Safety requirements for secondary batteries and battery installations |
| IEEE 946 | IEEE recommended practice for the design of DC auxiliary |
| IEC 60947 | Low voltage switchgear and control gear |
| IEC 61439 | Low voltage switchgear and control gear assemblies |

SECTION – VII

SCOPE OF WORK

SECTION-VII
SCOPE OF WORK

1.0 INTRODUCTION

WAPCOS Limited, as Project Management Consultant on behalf of National Educational Society for Tribal Students (NESTS), Ministry of Tribal Affairs (MoTA), Govt. of India, New Delhi invites percentage rate bid from interested Bidders for Construction of EMR Schools in the State of Jharkhand for the “Construction of Eklavya Model Residential School (EMRS) at Jaldega, District Simdega, Jharkhand”, herein after referred to as the Project /Work.

2.0 Scope of Work

2.1.1 General

The scope of work covered in this tender shall be as per the Schedule / Bill of Quantities, specifications, drawings, instructions, orders issued to the Contractor from time to time during the entire period of execution. The brief scope of works covered are listed below but not limited to the following:

| S. No | Building | Nos. |
|-------|---------------------------------------|------|
| 1 | School Buildings (G+2) | 1 |
| 2 | Boys' Hostel(G+1) | 2 |
| 3 | Girls' Hostels(G+1) | 2 |
| 4 | Warden Residence(G+1) | 1 |
| 6 | Kitchen & Dinning | 1 |
| 7 | Principal Quarter | 1 |
| 8 | Type III Quarters(G+1)- 15 Nos Qtrs | 15 |
| 9 | Type II Quarters (G+2) - 10 Nos Qtrs | 10 |
| 10 | Guest House In type-III quarter block | 1 |
| 11 | Sub Station Building | |
| 12 | Pump House/ Sump | |
| 13 | Sentry Booth | |

| Sports Facilities | | |
|--------------------------|-------------------------------------|--|
| 1 | Play Ground | Running Track as per Drawing/ site. |
| 2 | Kho Kho - Each for Boys & Girls | One Each for Boys & Girls of 27mx16m size. . Surface finished as per Drawing/ site. |
| 3 | Volley Ball - Each for Boys & Girls | 2 nos. Volleyball courts provided one each near Girls' and Boys' hostels. |
| | | Playing area size 9m X 18m |
| | | Surface finished as per Drawing. |
| | | player run-off is 13m x 22m |
| | | Surface finished as per Drawing/ site. |
| 4 | Basketball | 2 nos. Basketball courts provided one each near Girls' and Boys' hostels. |
| | | Playing area size of 15m x 20M |
| | | Surface finished as per Drawing. |

| | | |
|-----------------------|------------------------------------|---|
| | | player run-off is 19m x 32m |
| | | Surface finished as per Drawing/ site. |
| 5 | Archery Ground - 1 No | Archery Ground as per drawings/site. |
| | | |
| Fire Fighting | | |
| 1 | School | First Aid Hose Reel system and Fire Extinguisher Provided |
| 2 | Hostel | First Aid Hose Reel system and Fire Extinguisher Provided |
| | | |
| Drinking Water | | |
| 1 | Underground Tank | 1,00,000 Litres |
| 2 | Deep Boring | 2 nos. |
| 3 | Overhead Tank | Provided for School, Girls Hostels, Boys Hostels, Warden residence (Girls + Boys), Kitchen & Dining hall Type II Quarter, Type III Quarter, Principal Residence and Guest House. |
| 4 | External Water Supply System | Provided for School, Girls Hostels, Boys Hostels , Warden residence (Girls + Boys), Kitchen & Dining hall Type II Quarter, Type III Quarter, Principal Residence and Guest House |
| 5 | Pump Room with centrifugal pump | Construction of Pump Room with pumps |
| Green Features | | |
| 1 | Rain Water Harvesting | RWH Pit Provided or as per requirement/drawings. |
| 2 | Solar panel on roof top | May be provided from RESCO model |
| 3 | Landscaping & Herbal garden | Garden of area approx. 2000sqm |
| Others | | |
| 1 | Boundary Wall | Complete Construction of Boundary wall of Height 2.6m(1.8 m ht. Masonry wall + 0.8 m fencing with 600mm concertina coil over masonry wall). |
| 2 | Entry Gate with Security Room | Entry gate and Wicket gate is Provided |
| 3 | Flag Hoisting Stage | Provided in School Assembly Stage |
| 4 | Doors & Windows with Mosquito door | Provided in Type II, Type III, Principal, Guest House and Warden (BOYS & GIRLS) |
| 5 | Internal Roads | As per approved Master plan. |
| 6 | Internal pathways | As per approved Master plan. |
| 7 | Electric substation | HT Meter, HT VCB, LT panel room provided. |
| 8 | External Sewerage system | As per drawings/Septic Tank provided. |
| 9 | External Electrical Work | As per Electrical SLD. |
| 10 | Water supply | Provided for School, Girls Hostels , Boys Hostels , Warden residence (Girls + Boys), Kitchen & Dining hall Type II Quarter, Type III Quarter, Principal Residence and Guest House |
| 11 | SITC of substation equipment's | Provision of 250 kVA transformer - 01 no. |
| 12 | Street light | LED and Solar(As per approved drawing) |
| 13 | SITC of DG set | Provision of 62.5 kVA |
| 14 | SITC UPS | Provision of 10 kVA |
| | | |

Note:- Above components are as per present requirement which may be change after award as per site conditions and requirements of NESTS.

3.0 NOC'S / APPROVALS/ CLEARANCE FROM LOCAL BODIES/ AUTHORITIES

All the necessary Statuary Approvals/ NOCs/ Clearances such as Forest NoC, if necessary; approval of local Govt. body for architectural plans; Approval of ground water board, if necessary; clearance of height from concerned authority, if any; Fire NoC, Lift NoC, DG Sets, if any; which are required from any Govt. Department / body, before start of the work / during execution of work / after execution of work & before handing over the project, are the responsibility of the Contractor and are in the scope of work of the Contractor.

If any modification/revision is required in all the above mentioned Statuary Approvals/ NOCs/ Clearances, before start of the work / during the work / after execution of work are the responsibility of the Contractor and are in the scope of work of the Contractor. The fee deposited for getting approvals, shall be deposited by the Contractor to the concerned Department / Authorities and will be reimbursable to the Contractor on producing of original receipt of deposited fee and no extra cost for the same shall be claimed by the contractor.

4.0 TOPOGRAPHICAL SURVEY

The detail Topographical Survey work of entire site has already been carried out. However, Contractor/Bidder shall do site detail survey at his own cost, immediately after award of work to verify the survey data and demarcation of site as provided in the tender Master Layout Plan (MLP) to ensure the actual demarcation of the land as per MLP & related activities in consultation with State Officials. The details of survey done by contractor will be submitted to WAPCOS to handover the site.

In case if there is no any deviation in MLP, then site will be handed over to Contractor for start of execution. In case, any deviation in the MLP/ boundary line, the approval of revised MLP with reference to actual available land area/boundary shall be obtained by Contractor from WAPCOS / NESTS before start of the work. After approval of revised MLP, Site will be handed over to Contractor for start of execution.

In any case, WAPCOS shall be informed regarding final position of buildings at site including site development plan, contour level, etc. before commencement of building works.

No claim of Contractor in respect of discrepancy in topographical survey /levels, revision in MLP shall be entertained.

5.0 Reference to the Standard Codes of Practice

All Standards, Technical Specifications and Codes of practice referred to shall be latest editions including all applicable official amendments and revisions. The Contractor shall make available at site hard copies of all latest editions of relevant codes and specifications such as CPWD Specifications, Delhi Schedule Rates (2019), CPWD Specifications for Horticulture and Landscaping work (2018), and relevant/ applicable BIS codes.

Wherever Indian Standards do not cover some particular aspects of design/ construction, relevant International Standards shall be referred to. The Contractor shall make available at site such standard codes of practice.

6.0 LIST OF MAKE FOR CIVIL WORKS

Acceptable makes of materials to be used in the work are as follows. In case of non-availability of these makes, after the approval of WAPCOS/ NESTS, the Contractor can use the alternative makes only BIS marked materials of equivalent reputed brand. Non BIS marked materials may be permitted by the WAPCOS only when BIS marked materials are not manufactured. If any make / brand of the “Material / Article” is not mentioned in following make list, then standard top 5 Manufacturers/ Agencies /Brand Make for that “ Material / Agency” will be considered for approval by WAPCOS / NESTS.

| S.N | Material /Article | Confirming IS Code | Manufacturers/ Agencies /Brand Make |
|-----|--|---|--|
| 1. | Cement (OPC 43 grade) /PPC | IS : 8112: 1989/ IS : 1489 (Part-1) 2015 | A.C.C., Jaypee Cement, Ultratech, Shri Cement, Gujart Ambuja Cement, Star Cement, Cement Corporation of India, Dalmia InfraPro (Dalmia Bharat Cement), |
| 2. | AAC Blocks | - | Xtralite (Ultra Tech Cement Ltd.) Areocon (Hil), Nucon (Green Way building material India Pvt Ltd.), Magicrete (Magicrete Precast), NCL |
| 3. | Steel Reinforcement | IS 1786:2008 | Thermo Mechanically treated bars Fe-500 Grade conforming to IS 1786:2008 from approved brands i.e. SAIL, Tisco, RINL, JSW Steel Ltd, JINDAL, Shyam Steel |
| 4. | Structural Steel | IS 2062:2011 | SAIL, Tisco, RINL, JSW Steel Ltd, JINDAL, Shyam Steel |
| 5. | Stainless Steel | - | Jindal SS Ltd (JSL), Salem (SAIL), SAIL (SAIL), Shyam Steel |
| 6. | Corrugated GI Sheets | IS 277:2003 | TATA SAIL, JSW, JSPL, BHUSAN |
| 7. | Colour coated profile sheet | - | TATA KOMDA; JINDAL |
| 8. | Aluminium extruded sections | IS 733: 1983 & IS 1285:2002 | Jindal, Hindalco, Indian Aluminium Co. NALCO |
| 9. | Aluminium plain sheets | IS 733: 1983 & IS 1285:2002 | Jindal, Hindalco, Indian Aluminium Co. NALCO |
| 10. | Factory made Machine pressed laminated flush door shutter | IS 2202 (Part 1): 1999 And relevant IS Code | Century, Greenply, Kitply, Duroply Merino |
| 11. | Block Board | IS 1659:2004 | Century, Greenply, Kitply, Duroply Merino |
| 12. | Flush Door Shutter | IS 2202 (Part 1): 1999 | Century, Greenply, Kitply, Duroply Merino |
| 13. | Boiling Water proof plywood, Block board, Commercial Plywood | IS 303:1989 | Century, Greenply, Kitply, Duroply Merino |
| 14. | Aluminium door & window fittings | Relevant IS Code | Jyoti, Argent, Everest |
| 15. | PVC rigid foam sheet | - | Rajshri or equivalent |
| 16. | Hydraulic Floor Spring | IS 6315:1992 | Dorma, Hardwin, Ozone, Dorset |
| 17. | Door Closure | IS :3564 | Dorma, Hardwin, Ozone, Dorset |

| S.N | Material /Article | Confirming IS Code | Manufacturers/ Agencies /Brand Make |
|-----|--|--------------------------------|--|
| 18. | Float Glass | - | Saint Gobain (Saint Gobain India Pvt. Ltd.) Modiguard (Gujarat Guardian Ltd.) Asahi (Asahi India Glass Ltd.) |
| 19. | SWR uPVC pipe & fitting | IS 4985:2000 & IS 14233:1999 | Supreme, Finolex, Prince Astral, Prakash, Ashirwad |
| 20. | CPVC Pipe & fittings | IS 16088:2012, IS 15778:2007 | Supreme, Finolex, Prince Astral, Prakash, Ashirwad |
| 21. | Ceramic glazed wall tiles | IS 13712:1993 | Kajaria, Orientbell, Somany, NITCO, HR-Johnson |
| 22. | Vitrified Tiles | IS 15622:2006 | Kajaria, Orientbell, Somany, NITCO, HR-Johnson |
| 23. | Bitumen VG-30, VG-10 Etc. | IS 73:2013 | As per particular Specification of IOCL, BPCL, HPCL. |
| 24. | Admixtures | IS9103:1999 | FOSROC, SIKKA, CICO Technologies Ltd. Pidilite |
| 25. | Mild steel tubes | IS 1239:1990 | As per IS Code |
| 26. | 1 st quality acrylic distemper (Ready Mix) | | Bison (Lewis Berger), Beauty (NEROLAC), Tractor Uno (Asian Paints) |
| 27. | Premium Acrylic smooth exterior Paint with silicon additives | | ULTIMA (Asian Paint), Premium Exterior Emulsion (Dulux), Weather coat long life 7 (Berger) |
| 28. | Paints | IS : 101 : 1986 | Lewis Berger, Asian Paints, Nerolac, Dulux |
| 29. | Steel/Wood Primer Paints | IS : 14177 : 1994 | Lewis Berger, Asian Paints, Nerolac, Dulux |
| 30. | Factory Made C.C. Interlocking Paver Blocks | IS : 15658 : 2006 | NITCO, KK, NTC |
| 31. | Bitumen 85/25 | IS : 702 : 1988 | HPCI, IOCL |
| 32. | Water Proofing Compound | IS : 2645: 2003 | FOSROC, Dr. FIXIT, BASF,CICO, SIKKA |
| 33. | Crystalline Waterproofing Compound | IS : 2645: 2003 | FOSROC, Dr. FIXIT, BASF, SIKKA |
| 34. | G.I. Pipes | IS : 1239 | TATA, Jindal Hissar |
| 35. | PVC Water Storage Tanks | IS : 12701 : 1996 | Sintex, Plasto |
| 36. | P.T.M.T. Accessories | IS : 9763 | Prayag, Prakash |
| 37. | Mirror | | Saint Gobain (Saint Gobain India Pvt. Ltd.), Modiguard (Gujarat Guardian Ltd.) Asahi (Asahi India Glass Ltd.), Atul (Autl Glass Industries Ltd.) |
| 38. | Stainless Steel Sink | IS : 13983 : 1994 | Hindware, NIRALI, CERA, JAYNA |
| 39. | Sanitary ware /Chinaware | As per IS Code | Cera, Parryware, Hindware, Jaquar |
| 40. | C.P. Fittings and accessories for bathroom/toilets | IS: 7784 : 1993 | Jaquar, Gem, Parko, Hindware, Cera, Parryware |
| 41. | RCC Pipes | Confirming to IS Specification | Indian Hume Pipes (Indian Hume Pipe Ltd.) Jain & Co (Jain Spun Pipes Co) |
| 42. | SFRC Cover and grating | IS 12592 (2002) | KK (KK Manhole and gratings Co Pvt Ltd) |
| 43. | CI Manhole Cover | IS 1726 (1991) | RPFM (M/s Raj Pattern Makers & Founders Pvt Ltd.) BIC Bengal Iron Corporation), Neco (Jayaswal Neco Ltd.) |

| S.N | Material /Article | Confirming IS Code | Manufacturers/ Agencies /Brand Make |
|-----|--|--------------------|--|
| 44. | Foot Rest (for Manhole) | | KGM (KGM Exports), Accurate Buildcon (Accurate Buildconcompany) Neco (Jayaswal Neco Ltd) |
| 45. | Water stops | | Hydrotite (Sika India), Dr. FIXIT (Pidilite Industires), Ferrous Crete (Ferrous Crete (India) Pvt. Ltd.) |
| 46. | Aluminium doors/windows sections | IS 733 & IS 1285 | Hindalco (Hindalco Industries Ltd.) Jindal (Jindal Aluminium Ltd) |
| 47. | Glass Reinforced Concrete (GRC) jail | | Terrafirma (terrafirma GRC Industries), Ecovision (Ecovision Industries Pvt Ltd.). Mahesh GRC (Mahesh Prefab Pvt Ltd.) |
| 48. | SS Doors & Windows Hardware & Fittings | | JINDAL, Dorma, KICH, Godrej, Ozone |
| 49. | Wall Putty | | Dalmia, JK, Birla, Asian |
| 50. | Factory Made steel Glazed/ Gauged windows and ventilators | IS : 1038-1983 | SKS Steel Industries (Havlox)/Madhu Industries /Multiwin/M/s Classic Engineers and fabricators/Ajanta |
| 51. | Solar Lighting System | ECBC-2017 | WIPRO/Anchor-Panasonic/Philips/Crompton/TATA BP solar |
| 52. | CP Brass Fittings/Fixtures | IS : 8931 | Jaquar, Kohler, Marc (Premium Quality), Hindware, Parryware/Parko |
| 53. | Tubular Profile steel door/windows; Steel windows; Pressed steel door frames | | TATA/APL Apollo/ Jindal/ Classic Engineers & fabricators |
| 54. | Pre painted / powder coated CRC Windows | | APL Apollo/ Jindal/ Classic Engineers & fabricators/ JK Enterprises/ NCL Alltek & Seccolor Ltd. |

7.0 LIST OF MAKE FOR ELECTRICAL WORKS

Acceptable makes of materials to be used in the work are as follows. In case of non-availability of these makes, after the approval of WAPCOS/ NESTS, the Contractor can use the alternative makes only BIS marked materials of equivalent reputed brand. Non BIS marked materials may be permitted by the WAPCOS only when BIS marked materials are not manufactured. If any make / brand of the “Material / Article” is not mentioned in following make list, then standard top 5 Manufacturers/ Agencies /Brand Make for that “Material / Agency” will be considered for approval by WAPCOS / NESTS.

| S.N O. | Material /Article | Manufacturers/ Agencies /Brand Make |
|--------|----------------------------------|---|
| 1. | DG Engine | Ashok Leyland/Cummins/Cater pillar/KOEL Mahindra & Mahindra/Escorts |
| 2. | DG Alternator | Kirloskar/KEL/Crompton Greaves (AL. Series)/KEC/ Stamford |
| 3. | Battery (Lead Acid / Mntc. Free) | Amara Raja/Exide/Crompton Greaves/Prestolite/Pace Setter/Standard/ |
| 4. | HV Switchgear | Crompton/Kirloskar/Voltas/C&S Electric |
| 5. | LT Switchgear | L&T/Schneider Electric/Siemens/Legrand/Havells |

| S.N O. | Material /Article | Manufacturers/ Agencies /Brand Make |
|-----------|---|--|
| 6. | Vaccum Circuit Breaker | GE/Siemens/C&S Electric |
| 7. | Transformer (Oil filled / Dry Type) | ABB/ Crompton Greaves/ Kirloskar/ Siemens /Alstom/ Uttam |
| 8. | HT Panels | ABB/ Siemens/ L&T/Schneider/Kirloskar |
| 9. | Air Circuit Breaker | L&T/Schneider Electric/Siemens/Havells |
| 10. | MCCB (ICS=ICU) | L&T/Schneider Electric/Siemens/Legrand/Havells |
| 11. | MV/LT Panels | TTA/CPRI Fabricators with panels cleared by CPRI. Note: Contractor shall take prior approval of make of Panels before procurement. |
| 12. | SDF Units | L&T/Schneider Electric/Siemens/Legrand/Havells |
| 13. | Power Contractors | L&T/Schneider Electric/Siemens/BCH/GE/Power Controls |
| 14. | Change Over Switch | L&T/HPL/Havells/Standard/Control & Switch Gears |
| 15. | Air Brake Switch | National/Kiran/Pactil/Atlas/Power grid switchgears |
| 16. | Pin and Disc Insulator | Jayshree/WS/IEC/BHEL/Bharat Industries |
| 17. | 11 KV Horn Gap Arrestor | Sahal/Pactil/GEC/SEW |
| 18. | Lightning Arrestor | Atlas/GE/Elaro/Lamco/International Oblum/ Elpro |
| 19. | Drop out Fuses | National /Kiran/Pactil |
| 20. | GI/MS Pipe (ISI Maked) | ATC/ATL/BST/GSI/ITC/ITS/ IIA/JST/Jindal/TTA/ Tata/Zenith |
| 21. | APFC Relay | L&T/Schneider Electric/Neptune Ducati/Syntron/Trinity Electronics |
| 22. | IDMT Relay | AVKC/SEGC |
| 23. | C.T./P.T. | AE/MP/Marshal/Pactil/Kappa/L&T/Ashmor/Waco/Meco/ Gilbert/ Trio/Indotech/Indo coil |
| 24. | Selector Switch | L&T/Kaycee/IMP/Vaishno/Seizer/rass control |
| 25. | Indicating Lamp (LED Type) and Push But | Vaishno/Siemens/L&T/AE/IMP/Rass |
| 26. | Power Capacitors (MPP/APP) | Khatau/Junkar/L&T/ EPCOS(Siemens)/ABB/Crompton/Schneider Electric / Neptune Ducati |
| 27. | Digital Panel Meters i/c Multi-Function Meter | Conzerv/Schneider Electric/AE/Digitron/IMP/Meco/Rishabh/Univeral/HPL/L&T/ABB |
| 28. | Ammeter/ Voltmeter | AE/Univeral/Rishabh/Kaycee/Meco/Enercom |
| 29. | Cold shrink HT/LT Cable Joint Kit | Denson/3M(M-Seal)/Paychem |
| 30. | Rubber Matting (ISI Marked) | Jyoti Rubber Udyog/Raychem/Padmini/Dozz |
| 31. | AVM Pads | Dunlop/Poly Bond |
| 32. | MCB/Isolator/ELCB/RCCB/ Distribution Board | Crompton/Havells/MDS Legrand/L&T/ Schneider Electric/Siemens/Polycab/C&S/(Make of DBs and circuit breakers shall be same) |
| 33. | TPN Switches & HRC Fuses | Crompton/Havells/MDS Legrand/L&T/ Schneider Electric/Siemens/Polycab/C&S/(Make of DBs and circuit breakers shall be same) |
| 34. | PVC Conduits (ISI Marked) Colour: Ivory/Grey | AKG/Polycab/Avon Plast/Precision/finolex/Astral |
| 35. | Steel Conduits (ISI Marked) | BEC/Bharat/Gupta/AKG/RMCON/Steel Krafts |
| 36. | Piano/Modular Switches and Sockets | Legrand/Havells/Polycab/Schneider/ Anchor |
| 37. | Cable Tray | MEM/Bharti/Ratan/Slotco/Profab |

| S.N O. | Material /Article | Manufacturers/ Agencies /Brand Make |
|-----------|---|--|
| 38. | Cable Glands | MCI, Comet/Jainson/Dowells |
| 39. | Thimbles/Lugs | Jainson/Dowells/Ascon |
| 40. | 1.1 KV/11 KV grade AI. Condr., XLPE insulated armoured cables (ISI Marked) | Finolex/Havells/Polycab/KEI |
| 41. | Fire Survival cable | Finolex/Havells/Polycab/KEI |
| 42. | Wires (PVC insulated copper conductor cable FRLS – ISI marked)/ Telephone Cables/Submersible cables/ Co-axial/TV cables | Finolex/Havells/Polycab/KEI |
| 43. | Fans and Exhaust fans (All Types) | Khaitan / Havells/Crompton/Orient/ Bajaj/Usha/Polycab |
| 44. | LED Luminaries i/c street light fittings (ISI Marked) | Khaitan / Havells/Crompton/Orient /Bajaj/Usha/Polycab |
| 45. | LAN Cables | Panduit/Legrand/Schneider/Polycab |
| 46. | Centrifugal Pump | BE Power/Beacon/Crompton/ Kirloskar/KSB |
| 47. | Submersible Pump | BE Power/Beacon/Crompton/ Kirloskar/KSB |
| 48. | Motors | Crompton Greaves/Schneider Electric/Kkirloskar/ Siemens |
| 49. | Motor Starter | L&T/Siemens/BCH/GE Power Control/Schneider Electric |
| 50. | Fresh Air Fans | Khaitan/Havells/Crompton/Orient/Bajaj/Usha/Polycab |
| 51. | Single Phase Preventer / Overload Unit | L&T/ Minilec/Siemens |
| 52. | Timers | L&T/ Minilec/Siemens/AE |
| 53. | Gate Valve/Foot Valve/NRV/Butter Fly Valve | Advance/Audco/Johnson Controls/Zoloto/Annapurna /Fountain/Kirloskar/Leader/Sant/Trishul/Kartar/Inter Valve |
| 54. | Single/Double Headed GM Landing valve | New Age (Mumbai)/Safex/Ceasefire/Padmini/Life guard |
| 55. | Hydrant Valve | New Age (Mumbai)/Safex/Ceasefire/Kalpana/L&T valves Ltd. /Life guard |
| 56. | Sprinkler/ Hose reel & Hose Pipe (ISI marked) | Safex/Agni/Newage/Ceasefire/Fire Guard/Omex |
| 57. | Fire Extinguisher (ISI marked) | Minimax/Lifeguard/Safeguard/Safex/Omex |
| 58. | Water Purifier | Eureka Forbes/Kent/ion Exchange /LG |
| 59. | Inverter System | Sukam/Microtek/Luminous |
| 60. | Electrical Water Storage Heater | Racold/Crompton/Havells/Bajaj/Polycab |

8.0 PROJECT EXECUTION

8.1 Project Execution & Supervision Aspects

1. The Bidder, who shall act as Contractor for the project shall be composed of qualified and experienced experts, who can carry out all the routine construction works as a fully competent and independent unit.

However, in preparing his proposal for the construction, the Bidder should allow for a suitable mechanism which will ensure thorough co-ordination of the design and execution teams, so that each team is at all times fully aware of the remedies to common problems

used by the other team.

2. The Project Head/Project Manager Representative on behalf of the Contractor should be authorized with whom day to day interactions shall be made by the Engineer-in-Charge for execution and supervision of works. He should be a senior Civil Engineer with at least 20 years of professional experience out of which 10 years in planning and construction of building works. He should have executed at least one major building work of similar in nature as proposed by the Bidder. He should be familiar with modern construction equipment and Contract conditions. The candidate should have a thorough understanding and experience with IS code relating to building construction.
3. The Bidder shall provide competent personnel for the project execution and supervision who shall be managed by the Project Head/Project Manager at site in performing the assignment under this Contract.

The Bidder's personnel should have the required experience and expertise in conducting similar type of works with highest professional standards.

The Bidder is required to set-up the site office at the work site and make their own arrangements for the accommodation, furniture and equipment etc.

The project execution and supervision personnel should be mobilized from the date of commencement of works by the Bidder. During the Defects Liability Period, the Bidder would be expected to provide technical advisory services on an "as required" basis.

After award of the Contract, the Employer expects all of the proposed personnel to be available during implementation of the Contract.

4. It is the duty of the Contractor to:
 - Ensure that high quality of construction is achieved
 - Ensure that all works are carried out in full compliance with the Engineering design, technical specifications and Contract documents;
 - Check / conduct all necessary measurements, tests, and control the quality of various items of work s and in accordance with the relevant code of Building specification with the latest edition.

Key Personnel:

The Contractor shall employ the key personnel named in the Schedule of Key Personnel as referred to in **Enclosure-I** to carry out the functions stated in the Schedule or other personnel approved by the Engineer-in-Charge. The Engineer-in-Charge will approve any proposed replacement of key personnel only if their qualifications, abilities, and relevant experience are substantially equal to or better than those of the personnel listed in the Schedule.

If the Engineer-in-Charge asks the Contractor to remove a person who is a member of the Contractor's staff or his work force stating the reasons the Contractor shall ensure that the person leaves the Site within seven days and has no further connection with the work in the Contract.

8.2 Minimum Site Equipment Required

Availability (either owned or leased having validity for the period till completion of project) of the key and critical equipment required at site as per the quantum of work will be as per

Enclosure-II. The Bidder is to provide their own estimate of the number of equipment, commensurate with their work plan and methodology.

8.3 Equipment for Testing of Materials & Concrete at Site Laboratory

All necessary equipment for conducting necessary tests shall be provided at the site laboratory by the Bidder at his own cost as per **Enclosure-III**

8.4 Instructions of Engineer-in-Charge

The Engineer-in-Charge will, but not be limited to, the following:

- give the order to commence the works;
- inspect Contractor's plant and equipment's and recommend augmentation/rectification of deficiencies, if required
- order special tests of materials and/or completed works, and/or order removal and substitution of improper materials and/or the works as required;
- review all the test result/ certificates of all construction materials and inspect sources of materials to establish their quality suitable to the required standard.
- check all bituminous mix designs and concrete mix design proposed by the Bidder where ever required and in due time and suggest modifications in the mix design, laying methods, sampling and testing procedure and quality control measures, to ensure required standard and consistency in quality at the commencement of times;
- check and certify the laboratory and field tests carried out by the Contractor and also carry out independent tests, if required. The report of such test shall be submitted to the Engineer-in-Charge within a period of 7 days of such tests.
- inspect the works during the construction period and the Defects Liability Period, and to issue Defects Liability Certificates after rectification by the Contractor of defects notified to him by the Engineer-in-Charge;
- check the setting out the works;
- instruct the removal from the site of materials which are not as per specifications or reconstruction of parts of the works which do not comply with the specification;
- direct to submit monthly progress reports, Quarterly progress report, Final completion Report and Bar Chart / Programme chart to complete the work in stipulated time period.
- direct to prepare Running Account Bills for works carried out by the Contractor, and certify completion of parts or the totality of the works and record of measurements in the measurement book.
- direct to send certified bill to the WAPCOS office for approval of competent authority and payment.
- direct to prepare deviation / variation (if any) with duly certified supporting documents as per the provisions in contract and will send the same to WAPCOS office for the approval of Competent Authority.

8.5 Duties & Responsibilities of the Project Head/Project Manager of contractor

The duties of the Project Head/Project Manager of the Contractor are, to supervise construction of the works and, to test and examine any material to be used or workmanship employed in connection with the works. The principal responsibilities of the Project Head/Project Manager of the Contractor are likely to be but not limited to as follows:

- To follow the instructions given by the Engineer-in charge, Principal Employer and WAPCOS
- To prepare detailed bar chart depicting each & every activity of the work along with quantity and time bar, to complete the work in stipulated time period, which will be displayed in the Site office.
- To provide the all residential facility at site camp to the Engineer-in-Charge as per provisions
- to ensure that the construction work is accomplished in accordance with the technical specifications and Contract Conditions;
- to identify construction problems and delays and to recommend to the Engineer-in-Charge, actions to expedite progress
- to ensure proper keeping of records
- to monitor and check the day-to-day quality control and quantity measurements of the work carried out under the Contract
- to prepare in consultation with the Engineer-in-Charge, a Construction Supervision Manual outlining routine and procedures to be applied in Contract management, construction supervision and administration;
- to prepare a maintenance manual outlining the routines to be adopted in each specific reach and for the cross-drainage works and buildings;
- to comply with his contractual obligations in executing work in all matters concerning safety and care of the works (including the erection of temporary signs) and, if required, to request the Contractor to provide any necessary lights, guards, fencing and watchmen for smooth and effective working and traffic flow.
- to write a day-by-day project diary which shall record all events pertaining to the administration of the Contract, request forms and orders given to the Contractor, and any other information which may at a later date be of assistance in resolving queries which may arise concerning execution of the works;
- preparation & submission of monthly progress reports, Quarterly progress report, Final completion Report.
- Preparation, Submission & time to time revision of Bar Chart / Programme chart to complete the work in stipulated time period.
- Any other work as outlined in contract agreement, which is the responsibility of the Contractor.

8.6 Documents Prepared Shall be the Property of the Employer

All plans, drawings, specifications, designs, reports and other documents (both computer hard copies and soft copies) in performing the works shall become and remain the property of the Employer, and the Contractor shall, not later than upon termination or expiration of this Contract, deliver all such documents to the Employer, together with a detailed inventory thereof. The Contractor may retain a copy of such documents but shall not use these documents for purposes unrelated to this Contract without the priory written approval of the Employer.

8.7 Completion Schedule/deliverables

9.0 The works has to be completed in the following phasing:

| SN. | Description of Mile stone | Time allowed |
|-----|---------------------------|--------------|
|-----|---------------------------|--------------|

| | (Physical) | (from the date of start) |
|---|--|---------------------------------|
| 1 | 1/8 th of the whole of the work | Within 4.5 months |
| 2 | 3/8 th of the whole of the work | Within 9 months |
| 3 | 3/4 th of the whole of the work | Within 13.5 months |
| 4 | Whole of the work | Within 18 months |

Note: The work of plantation, internal & external services, etc. shall be completed simultaneously during the progress of work as and when the site is available for the same, as per direction of Engineer-in-Charge.

9.1 Other Site Facilities

The cost of providing the work/facilities stated below are to be borne by the Contractor and shall be deemed to be included in the quoted cost by the Contractor.

- The contractor shall provide Residential accommodation at construction camp for WAPCOS Site Engineer / Inspection Team, comprising of fully furnished 1 room set with attached kitchen & toilet along with full facilities of 24 hours electricity & drinking water supply. The size of room shall be 12ft X 12ft., size of Kitchen 6ft X 6ft and size of Toilet 6ft X 6ft along with 2 nos. single beds with mattress, 2 cupboards, 1 table & 2 chairs.
- Office Accommodation & Mobility and Communication: On account of furnished Project office equipped with all facilities such as telephone, fax, internet, photocopier, computer/ laptop & printer along with operator, regular electric & purified drinking water supply and inspection vehicle etc. as per the requirement of the project an amount equal to 1.00% of gross bill from all running account & final bill will be recovered.
- The contractor shall also make sufficient arrangement for Photography/Videography preferably by maintaining a camera/video camera at site so that video photographs.
- The Contractor shall regularly share the geotagged photographs of ongoing construction to designated what's App group. The photographs need to be shared in every stage of construction for important items and milestones like foundation reinforcement, RCC casting of foundations, columns, beams & slab, masonry work, etc. These photographs shall also be submitted as part of each Running Account Bill.
- The Contractor shall provide at his own cost, One Site sign Board, at directed location of overall size 2.40 metres wide and 1.50 metres height and of approved design. The names of the Project, Employer, Consultants, Engineer and Contractor etc. shall be exhibited as directed.
- The Contractor shall make all arrangements for ground breaking ceremony/ inaugural function etc for the project as required and the cost towards it deemed to be included in his rates/offer.
- The same shall be furnished as per requirement of Monthly Progress report / Quarterly Progress Report/ Final completion report.
- The Contractor shall provide arrangements for firefighting at his own cost. For this purpose, he shall provide requisite number of fire extinguishers and adequate number of buckets, some of which are to be always kept filled with sand and some with water. This equipment shall be provided at suitable prominent and easily accessible places and shall be properly maintained. The Contractor may be subject to periodic fire prevention inspections and any deficiency or unsafe condition shall be corrected by the Contractor at his own cost and to approval of the Engineer-in-Charge and the relevant authorities.

These fire prevention inspections shall include but not limited to the following:

- ✓ Proper handling, storage and disposal of combustible materials, liquids and wastes.
 - ✓ Work operations which can create fire hazards.
 - ✓ Access for firefighting equipment.
 - ✓ Type, size, number and location of fire extinguishers or other firefighting equipment.
 - ✓ Inspection and maintenance records for extinguishers
 - ✓ Type, number and location of containers for the removal of surplus materials and rubbish.
 - ✓ General housekeeping
- For the purpose of quick communication between the Engineer-in-Charge and the Contractor or his Representative, Site Order Books shall be maintained at site in the manner as described below:

Any communication, relating to the works may be conveyed through records in the site order book. Such a communication from one party to the other shall be deemed to have been adequately served in terms of the Contract. Each site order book shall have machine- numbered pages in triplicate and shall be carefully maintained and preserved by the Contractor and shall be made available to the Engineer-in-Charge as and when demanded. Any instruction which the Engineer-in-Charge may like to issue to the Contractor may be recorded by him in the site order book and two copies thereof taken by the Engineer-in-Charge for his record. The Contractor or his Contractor or Representative may similarly record in the site order book any communication he may like to send to the Engineer-in-Charge. Two copies thereof when sent to the Engineer-in-Charge and receipt obtained thereof, will constitute adequate services of the communication to the Engineer-in-Charge.

- The Contractor shall display all permissions, licenses, registration certificates and other statements required to be displayed under various labour laws and other legislations applicable to the works at the site office and also maintain the requisite register / records factually and up to date and keep them ready for inspection by the concerned authorities and also make available the same to the Engineer-in-Charge / Owner for inspection.
- The relevant I.S. codes of practice and other relevant codes shall be of latest version with their amendments/ revisions. The Contractor shall keep and maintain copies of the latest editions of codes at the work site and make it available to Employer whenever required.
- In case of Guarantees specified for certain periods for due performance of materials and specialist items of work, the Contractor shall be a co-guarantor with the Specialist Contractor or Supplier offering such Guarantee and shall offer such co- Guarantee in a format approved by the Employer.
- The Contractor has to make own security arrangement. Contractor shall maintain upto date record of in & out of the material & labour / staff at the security gate of campus at its own expenses.
- If desired by the Employer, the Contractor shall stack and spread to the require profile the excess earth available suitable for filling in layers not exceeding 200mm, watering, consolidation within the campus and dispose of all surplus material to the nearest dumping ground/ land fill area without any additional cost, etc.
- The Employer may if require, request the assistance of Contractor labour for purpose other than from part of Contract. The Contractor will not unreasonably deny such assistance and the Engineer-in-Charge decision in this regard shall be binding on the Contractor. The Contractor will be then paid on the basis of minimum wages rates and provision made in the General Conditions of Contract.

- The Contractor shall provide safety equipment to the Employers/officers (whenever required).
- Contractor shall deploy security/ watchmen for 24 hours on site at entire execution period and up to successful handing over of the project to the NESTS.
- Contractor shall provide safety gadgets to the Employer officers.
- Contractor shall properly cover up & protect all the work throughout the duration of work at his cost until successful handing over to the NESTS, particularly flooring, risers, mouldings, steps, terrace or special floor finishes (by a layer of 25 mm thick Plaster of Paris over Polyethylene sheet as approved by Engineer-in-Charge) staircases and balustrades, doors and glass, paint work, furniture and all finishing.

9.2 Drawings

9.2.1 Good for Construction Drawings

The work shall be carried out in accordance with the approved architectural drawings, structural drawings, MEP services drawings to be issued from time to time, by the Engineer-in-Charge, and approved shop drawings prepared by the Contractor. Before commencement of any item of work the Contractor shall correlate all the relevant architectural and structural drawings, nomenclature of items and specifications etc. issued for the work and satisfy himself that the information available from there is complete and unambiguous. The figure and written dimension of the drawings shall be superseding the measurement by scale.

The stage wise drawings shall be released as “GOOD FOR CONSTRUCTION” from time to time as per requirement of that particular stage, by the Engineer-in-Charge and revised drawings as per any additions/ modifications/ alterations/ deletions will be issued to the Contractor progressively. The discrepancy, if any, shall be brought to the notice of the Engineer-in-Charge before execution of the work. The Contractor alone shall be responsible for any loss or damage occurring by the commencement of work based on any erroneous and or incomplete information and no claim whatsoever shall be entertained by the department on this account.

The levels, measurements and other information concerning the existing site as shown on the conceptual / layout drawings are believed to be correct, but the Bidders should verify the same for themselves and also examine the nature of the ground as no claim or allowance whatsoever shall be entertained on account of any errors or omissions and commissions in the levels or strata turning out different from what is shown on the drawings.

Two copy of contract documents including Drawings furnished to the Contractor shall be kept at the Sites and the same shall at all reasonable times be available for inspection.

9.2.2 Coordinated drawings

Before taking up the work, the Contractor shall prepare shop drawings for the works listed below for various civil and electrical services showing details of layout in plan including sections & elevations & large-scale details and Contractor shall plan and mobilize his resources as per these drawings and as per actual site conditions to facilitate convenient execution, installation as well as maintenance of these items. Nothing extra shall be payable on this account.

9.2.3 Shop drawings

The bill of quantities, technical specifications and drawings together shall be considered as a tender requirement and the work shall be carried out as per good for construction (GFC) drawings, issued by Engineer-in-Charge. The Contractor shall study the GFC drawings and

taking into account actual site conditions and selected material and requirements shall prepare shop drawings for the following works, as fully coordinated drawings, as given above.

- a. Aluminium work, Stainless steel work and railings etc.
- b. Expansion joint work
- c. Reflected Ceiling Plan (RCP), coordinated with all ceiling related services.
- d. Marble, granite, vitreous, ceramic, tile work details.
- e. All Electrical work
- f. All Sanitary and sewerage work
- g. All plumbing works.
- h. Rainwater Pipe details/ position, roof slopes etc.
- i. Drainage details.
- j. Door Window details
- k. All steel fabrication work.
- l. Fixture, Furniture and Equipment (FFE) work.
- m. Any other works detail if required.

Within the time frame agreed with the Engineer-in-Charge, the Contractor shall prepare shop drawings using latest version of AutoCAD. Shop drawings shall show all layouts, details in plans & sections showing all connections, junctions, bends, supports, clearances. Fixing arrangements with dimensions room, etc shall be prepared by the Contractor on AutoCAD based on the architectural drawings and site measurements. All measurable items quantities shall be mentioned on each shop drawing being submitted for approval by the Contractor. 3 sets of shop drawings (soft copy also) shall be submitted for approval and Seven sets of final shop drawings after approval by Engineer-in-Charge shall be submitted by the Contractor along with the soft copy. The shop drawings, shall be prepared as per schedule given in PERT Chart.

Technical submittals of manufacturer's catalogues and technical data shall be submitted for approval. The Contractor shall designate an Engineer responsible for issue and preparation of shop drawings and control of GFC drawings.

9.2.4 As built drawings

- i. The Contractor shall make available four (04) sets of completed Building Drawings, "As Built Drawings" along with literatures, manuals, warranty certificates etc. of various installed fittings, fixtures and equipment for the completed projects. This shall be the prerequisite for payment of final bill.
- ii. The Contractor shall make available three (03) sets of all services drawings including Electrical & HVAC work internal and external services i.e. Water Supply, Sanitary line and Drainage lines. This shall be the prerequisite for payment of final bill. These drawings shall have the following information:
 - a. Run off for all piping and their diameters including soil, waste pipes and vertical stacks.
 - b. Ground and invert level of all drainage pipes together with locations of all manholes and connections, up to outfall.
 - c. Run off for all water supply lines with diameters location of control valves, access panels etc.

9.3 Testing and Commissioning

- The Contractor shall arrange electricity at his own cost for testing of the various electrical and mechanical installations as directed by Engineer-in-Charge and for the consumption by the Contractor for executing the work. Also all the water required for testing various electrical installations, fire pumps, firefighting/ firefighting equipment, fire sprinklers.

and testing water supply, sanitary and drainage lines, water proofing of underground sump, overhead tanks, water proofing treatment etc. shall be arranged by the Contractor at his own cost. Nothing extra shall be payable on this account.

- Testing of equipment shall be carried out as per technical Specifications, manufacturer's recommendation and latest standards available up to date. The testing report shall be submitted along with Operation and Maintenance manual of the equipment at the time of handover.
- Contactor to provide training for operation and maintenance of equipment through respective manufacturer for the routine and preventative maintenance of equipment post Defect Liability Period.
- The Contractor shall demonstrate trouble free functioning of all the Civil and E&M installation sand services. The Engineer-in-Charge or his authorized representatives shall carry out final inspection of the various Civil and E & M services and installations. Any defect(s) noticed during demonstration shall be rectified by the Contractor at his own cost to the entire satisfaction of the Engineer-in-Charge. Nothing extra shall be payable on this account.

Enclosure-I
Desired Site Organization Structure

Minimum Level of Execution Team and Qualification/Experience of Key Staff to be deployed by the Contractor during execution of relevant works/fields is as follows:

| SN. | Designation | Qualification | Minimum Experience | Minimum No. Required | Rate at which recovery shall be made from the contractor in the event of not fulfilling |
|----------|---|--------------------------------|--------------------|----------------------|---|
| A | Principal Technical Representative | | | | |
| 1 | Project Head/ Project Manager | Graduate Engineer (Civil) | 20 years | 1 | Rs. 60,000/- per month |
| 2 | Project Engineer (Civil) | Graduate Engineer (Civil) | 10 years | 1 | Rs. 35,000/- per month |
| 3 | Project Engineer (Electrical) | Graduate Engineer (Electrical) | 8 years | 1 | Rs. 30,000/- per month |
| 4 | Quality Engineer | Graduate Engineer | 5 years | 1 | Rs. 20,000/- per month |
| 5 | Surveyor | Diploma Engineer | 5 years | 1 | Rs. 20,000/- per month |

Enclosure-II
Deployment of Minimum no. of Plant and Machinery by the Contractor

Whereas it is entirely the responsibility of the contractor to deploy sufficient plant and modern mechanical equipment to ensure compliance with the Contract, the following list is an indicative list of the minimum plant and machinery.

| SN. | List of Plants and Machineries | Minimum nos. required |
|------------|---|--|
| 1 | Batch Mix Concrete Plant with the provision of SCADA of adequate capacity (18 Cubic meters per hour and above) at each site | 1 no. |
| 2 | Field testing equipment | 1 set or more as per site requirement |
| 3 | Rock Drilling Equipment | 10 no. or more as per site requirement |
| 4 | Latest model of Theodolite + Levelling | 1 no. |
| 5 | Total Station | 1 no. |
| 6 | Truck & tipper | 1 no. or more as per site requirement |
| 7 | Transit Mixer (at least 6 cubic metre capacity) | 1 no. or more as per site requirement |
| 8 | Vibrator equipment (electrical & fuel type) | 4 no. or more as per site requirement |
| 9 | Concrete pump of capacity at least 15 cubic metre per hour | 1 no. |
| 10 | Mechanical excavator (Crawler mounted) | 1 no. |
| 11 | Loader with Backhoe (tyre mounted) | 1 no. |
| 12 | Minimum Steel staging & shuttering material | As per site requirement and to complete the work within schedule time period |
| 13 | Water Pumps | 1 no. or more as per site requirement. |
| 14 | Compaction Roller | 1 no. |

Note: The Bidder shall deploy additional plant & machinery as deemed fit and required to complete the project within stipulated completion period, without any additional cost to the Employer.

Enclosure-III

Equipment for Testing of Materials & Concrete at Site Laboratory

All necessary equipment for conducting necessary tests shall be provided at the site laboratory by the Bidder at his own cost as per following details.

| SN | Equipment | Quantity |
|-----------|--|--------------------|
| A | Mandatory Equipment | |
| 1 | Automatic Cube testing machine | 1 No. |
| 2 | Slump Cone | 2 Nos. |
| 3 | Weighing scale platform type 100 kg capacity | 1 No. |
| 4 | Sets of sieves for coarse aggregate (40,20,10,4.75mm) | 1 Nos. |
| 5 | Sets of sieves for fine aggregate [4.75; 2.36, 18; 600; 300 & 150 micron | 1 Nos. |
| 6 | Cube moulds size 150mm x 150mm x 150mm | 30 Nos. |
| 7 | Core cutter for soil compaction with accessories | 1 No. |
| 8 | Rebound hammer test Digital rebound hammer | 1 No. |
| 9 | Digital pH meter least count 0.1pH | 1 No. |
| 10 | Graduated glass cylinder | 2 No. |
| 11 | Water testing Kit | 1 No. |
| 12 | TDS meter | 2 No. |
| 13 | Hot Air Oven Temp. Range 50°C to 300°C | 1 No. |
| 14 | Measuring Jars 100ml, 200ml, 500ml | 1 set of each size |
| 15 | Moisture content rapid moisture meter standard | 1 No. |
| 16 | Poker Thermometer (Concrete Road) 0°C to 100°C | 1 No. |
| 17 | Vernier calipers 12" and 6" sizes | 1 No. each |
| 18 | Electronic balance 600g x 0.01g, 10kg and 50kg | 1 No. |
| 19 | Aggregate impact value testing machine with blow counter | 1 No. |
| 20 | Separate Cube Tank for 7 days cube testing | 1 No. |
| 21 | Separate Cube Tank for 28 days cube testing | 1 No. |
| | | |
| B | Other Equipment as and when required | |
| 1 | Tensile Briquette testing machine | |
| 2 | Vicats apparatus with Desk Pot | |
| 3 | Megger & earth resistance tester | |
| 4 | Pumps and pressure gauges for hydraulic testing of pipes | |
| 5 | Physical balance weight up to 5kg | |
| 6 | Digital thermometer up to 1500°C | |
| 7 | Gauging trowels 100mm & 200mm with wooden | |
| 8 | Spatula 100mm & 200mm with long blade wooden handle | |
| 9 | Crushing value apparatus | |
| 10 | Screw gauge 0.1mm – 10mm, least count 0.05 mm | |
| 11 | GI tray 600x450x50mm, 450x300x40mm, 300x250x40mm | |
| 12 | Digital Micrometer least count 0.01mm | |
| 13 | Digital paint thickness meter for steel 500-micron range | |
| 14 | Electric Mortar mixer 0.25 Cum capacity | |
| 15 | Thickness gauge for measuring flakiness index | |
| 16 | Elongation gauge | |
| 17 | Measuring Cylinder 3,5,10 & 15 litre Cylinder | |
| 18 | Pycnometer | |
| 19 | Pulse velocity Test | |
| 20 | Bar Relocator | |
| 21 | Other Equipment as required for the work and as required by | |

| SN | Equipment | Quantity |
|----|---------------------|----------|
| | the Inspection Team | |

NOTE: Any other equipment for laboratory tests at site will be the way it is outlined in relevant IS Codes and / or as directed by the Employer's Representative. Quality Control Engineer shall monitor collection of Sample and conducting regular testing at site maintaining propriety and the very best standard followed in industry of construction. All relevant IS Codes, special publications as per latest amendment/edition shall be referred.

SECTION – VII

TENDER DRAWINGS

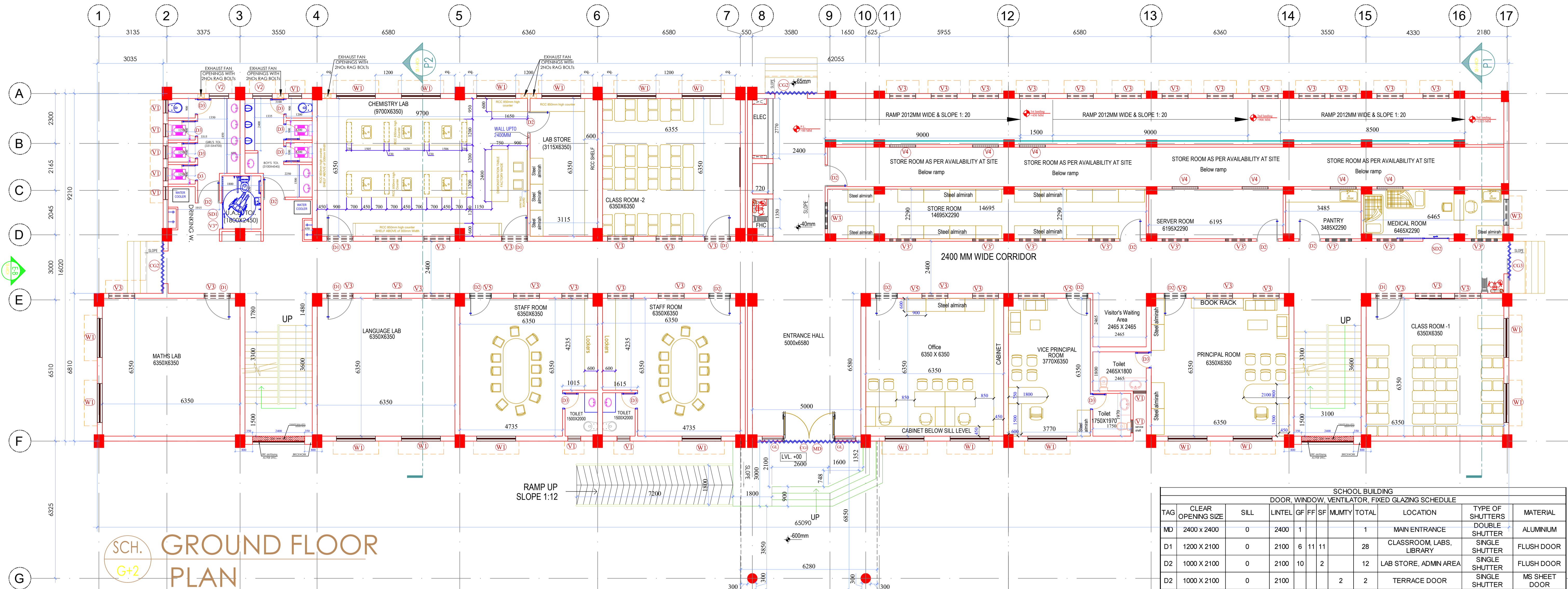

SCH. G+2
GROUND FLOOR PLAN

| AREA STATEMENT | |
|--|----------------|
| SCHOOL BUILDING | |
| DETAILS | AREA (in Sqm) |
| MAIN BUILDING | |
| GROUND FLOOR PLINTH AREA | 875.40 |
| FIRST FLOOR PLINTH AREA | 803.54 |
| SECOND FLOOR PLINTH AREA | 803.54 |
| TOTAL AREA | 2482.48 |
| ENTRANCE PORCH AREA | |
| AREA OF PORCH / 2 | 21.51 |
| Ramp AREA | |
| AREA AT GROUND FLOOR (AREA/2) | 68.13 |
| AREA AT FIRST FLOOR (AREA/2) | 105.95 |
| TOTAL COVERED AREA (RAMP AREA EXCLUDED) | 2678.00 |

| SCHOOL BUILDING | | | | | | | | | | | |
|--|--------------------|-------------|--------|----|----|----|-------|-------|---|------------------|-------------------------|
| DOOR, WINDOW, VENTILATOR, FIXED GLAZING SCHEDULE | | | | | | | | | | | |
| TAG | CLEAR OPENING SIZE | SILL | LINTEL | GF | FF | SF | MUMTY | TOTAL | LOCATION | TYPE OF SHUTTERS | MATERIAL |
| MD | 2400 X 2400 | 0 | 2400 | 1 | | | | 1 | MAIN ENTRANCE | DOUBLE SHUTTER | ALUMINIUM |
| D1 | 1200 X 2100 | 0 | 2100 | 6 | 11 | 11 | | 28 | CLASSROOM, LABS, LIBRARY | SINGLE SHUTTER | FLUSH DOOR |
| D2 | 1000 X 2100 | 0 | 2100 | 10 | | | | 12 | LAB STORE, ADMIN AREA | SINGLE SHUTTER | FLUSH DOOR |
| D2 | 1000 X 2100 | 0 | 2100 | | | | 2 | 2 | TERRACE DOOR | SINGLE SHUTTER | MS SHEET DOOR |
| D2 | 1000 X 2100 | 0 | 2100 | 2 | 2 | 2 | | 6 | TOILET MAIN ENTRY | SINGLE SHUTTER | PRELAMINATED DOOR |
| D3 | 750 X 2100 | 0 | 2100 | 11 | 7 | 7 | | 25 | WC DOOR | SINGLE SHUTTER | PRELAMINATED DOOR |
| SD1 | 1200 X 2100 | 0 | 2100 | 1 | 1 | 1 | | 3 | H.TOILET | SLIDING DOOR | PRELAMINATED DOOR |
| SD1 | 1200 X 2100 | 0 | 2100 | 1 | | | | 1 | MEDICAL ROOM | SLIDING DOOR | FLUSH DOOR |
| CG1 | 4800 X 2400 | 0 | 2400 | 1 | | | | 1 | MAIN ENTRANCE | | COLLAPSIBLE GATE |
| CG2 | 2400 X 2100 | 0 | 2100 | 2 | | | | 2 | CORRIDOR END | | COLLAPSIBLE GATE |
| CG3 | 1800 X 2100 | 0 | 2100 | 1 | | | | 1 | CORRIDOR END | | COLLAPSIBLE GATE |
| W1 | 1800 X 1500 | 900 | 2400 | 19 | 26 | 28 | | 73 | CLASSROOM, ADMIN AREA, LABS, CORRIDOR END | | STEEL GLAZED WINDOW |
| W2 | 1800 X 900 | 900 | 1800 | | 2 | | | 2 | RECREATIONAL ROOM | | STEEL GLAZED WINDOW |
| W3 | 1200 X 1200 | 900 | 2100 | 2 | | | | 2 | PANTRY, STORE | | STEEL GLAZED WINDOW |
| GL | 960 X 2100 | 300 | 2400 | 2 | | | | 2 | MAIN ENTRANCE | | ALUMINIUM FIXED GLAZING |
| V1 | 600 X 600 | 1800 | 2400 | 10 | 6 | 6 | | 22 | TOILET | | STEEL SECTION |
| V2 | 900 X 1200 | 1200 | 2400 | 2 | 2 | 2 | | 6 | TOILET | | STEEL SECTION |
| V3 | 1200 X 600 | AS PER SITE | B.O.B | 36 | 48 | 44 | | 128 | CLASSROOM, ADMIN AREA, LABS, RAMP | | STEEL SECTION |
| V3' | 1200 X 600 | AS PER SITE | 2100 | 9 | | | | 9 | STORE, SERVER, MEDICAL, PANTRY | sliding | ALUMINIUM |
| V3* | 1200 X 600 | AS PER SITE | B.O.B | 1 | 1 | 1 | | 3 | H.TOILET | | STEEL SECTION |
| V4 | 1200 X 450 | AS PER SITE | B.O.B | 7 | | | | 7 | STORE, MEDICAL ROOM, PANTRY | sliding | ALUMINIUM |
| V5 | 1000 X 600 | AS PER SITE | B.O.B | 5 | | | | 5 | STAFFROOM, OFFICE, V.PRINCIPAL, PRINCIPAL | | STEEL SECTION |

DATE - 09 MARCH 2023

DWG. NO.-
EMRS NAME/SCH/AR_01

SCALE:

MINISTRY OF TRIBAL AFFAIRS
NATIONAL EDUCATION SOCIETY FOR TRIBAL STUDENTS (NESTS)

SCHOOL
GROUND FLOOR PLAN

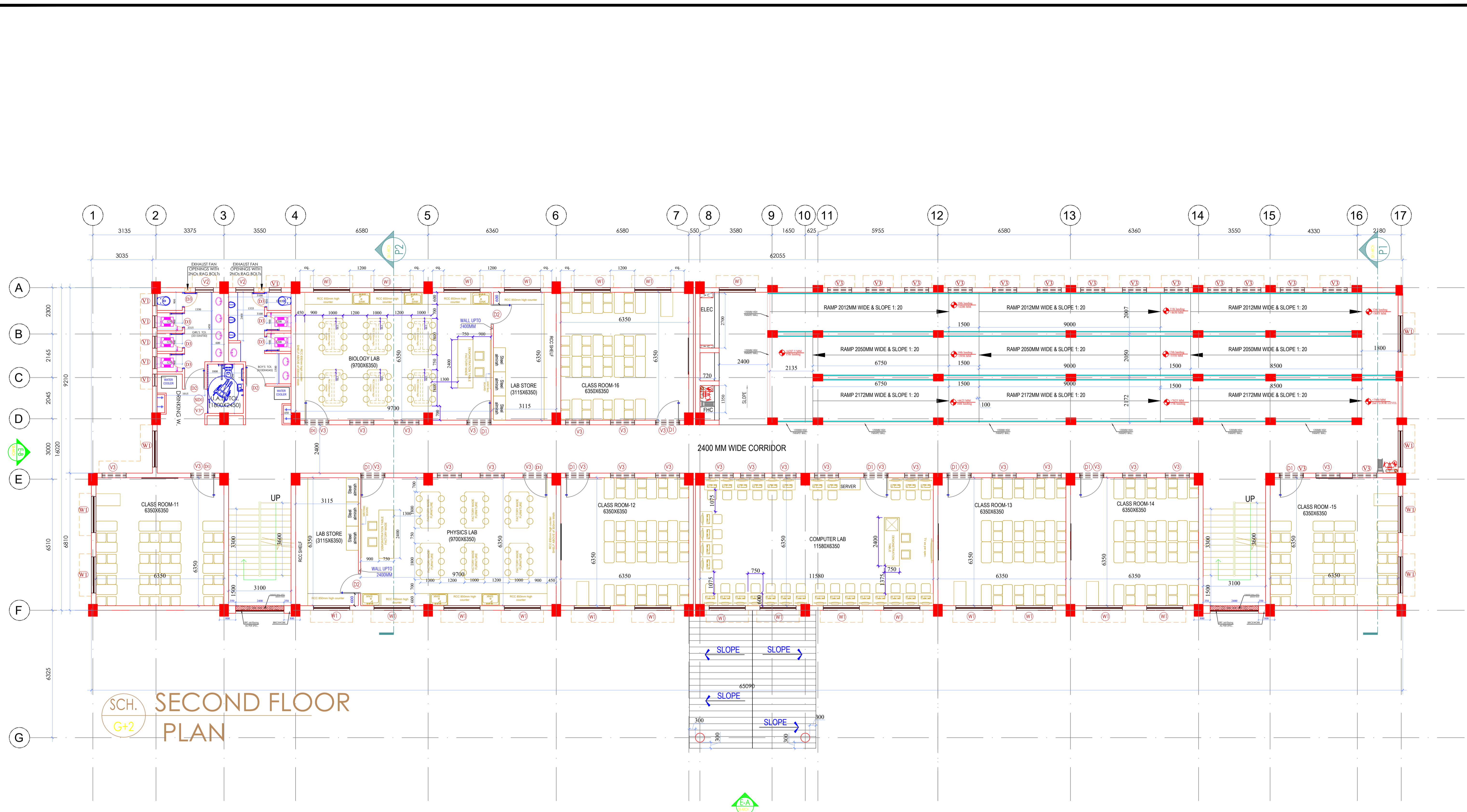

DATE - 09 MARCH 2023

DWG. NO.-
EMRS NAME/SCH/AR_03

SCHOOL
SECOND FLOOR PLAN

SCALE:

MINISTRY OF TRIBAL AFFAIRS
NATIONAL EDUCATION SOCIETY FOR TRIBAL STUDENTS (NESTS)

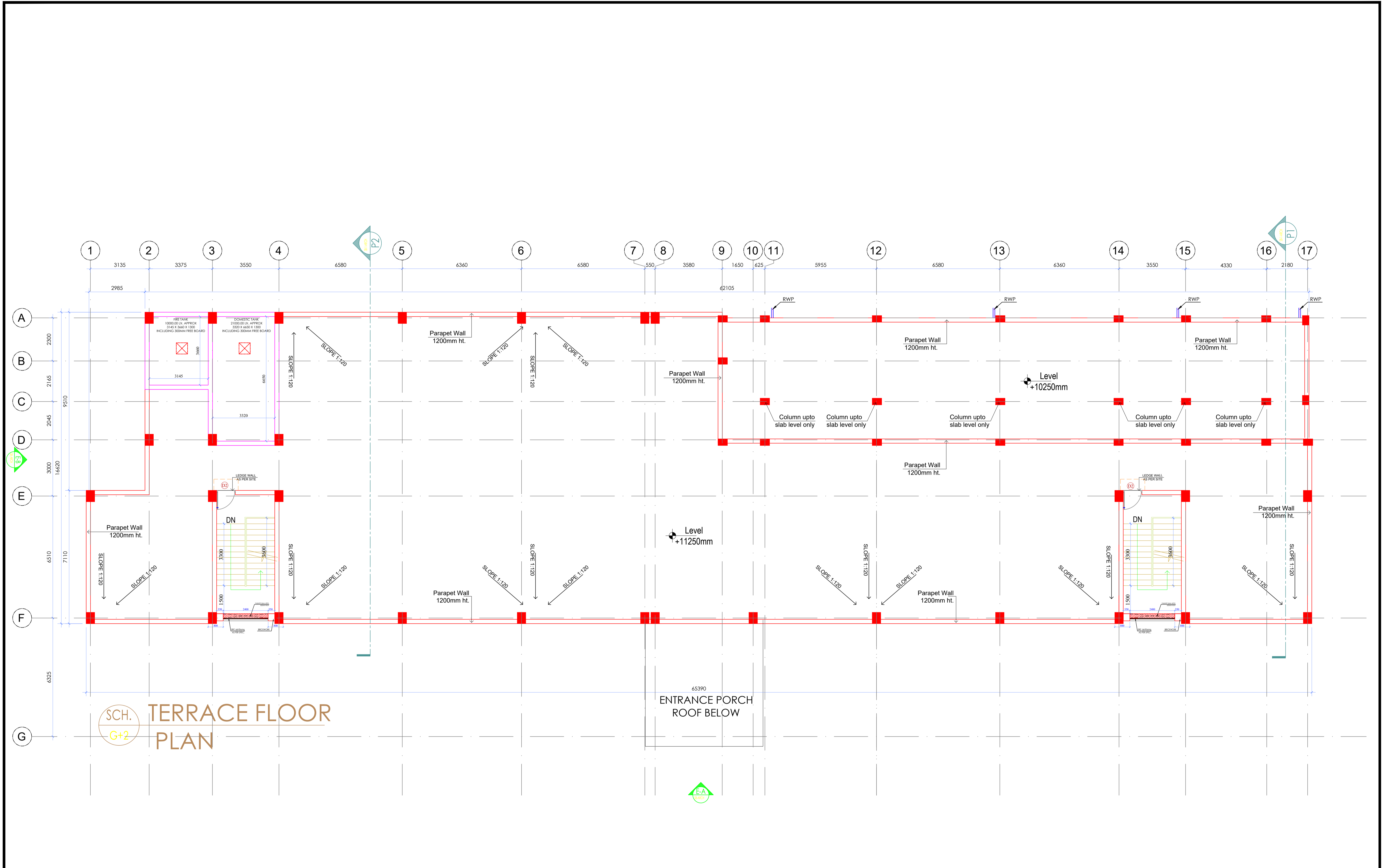

DATE - 09 MARCH 2023

DWG. NO.-
EMRS NAME/SCH/AR_04

SCHOOL
ROOF FLOOR PLAN

SCALE:

MINISTRY OF TRIBAL AFFAIRS
NATIONAL EDUCATION SOCIETY FOR TRIBAL STUDENTS (NESTS)

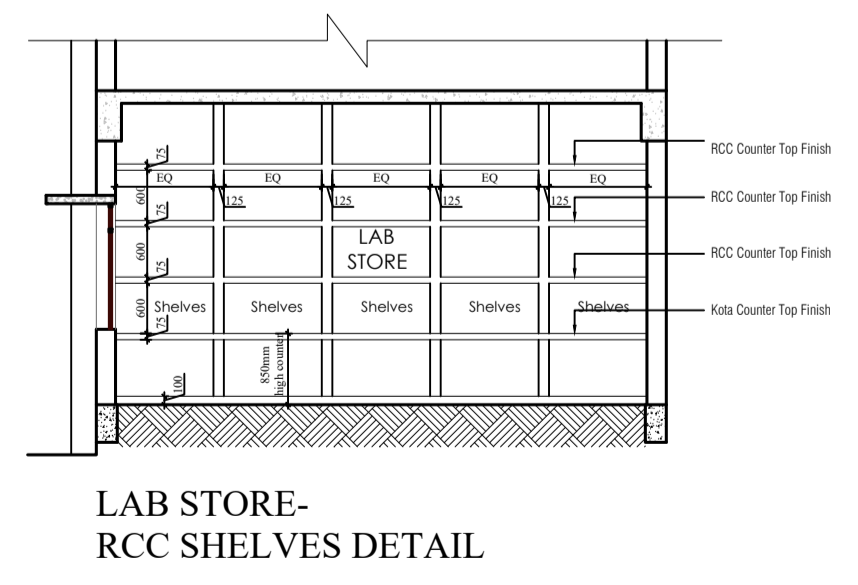
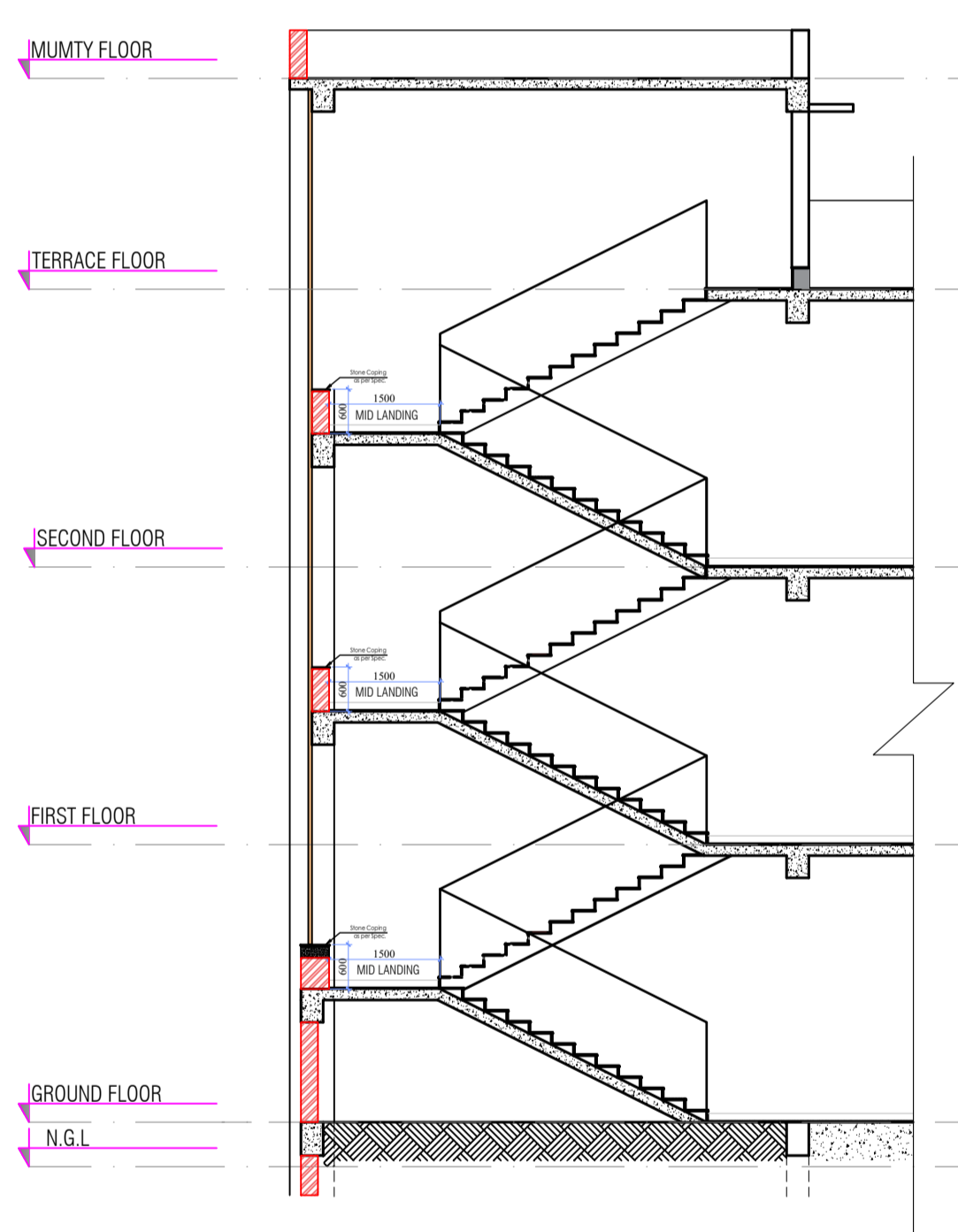
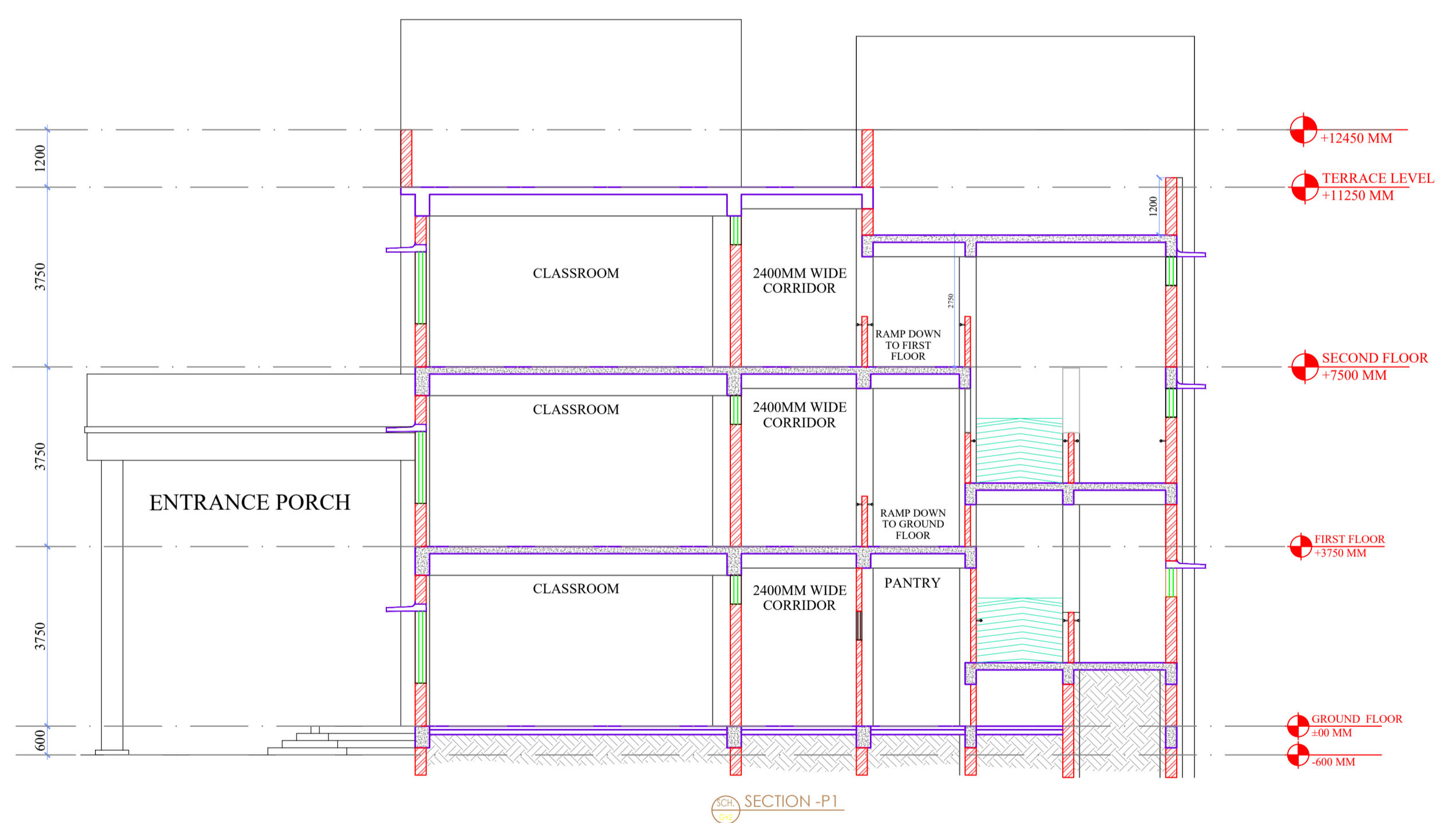
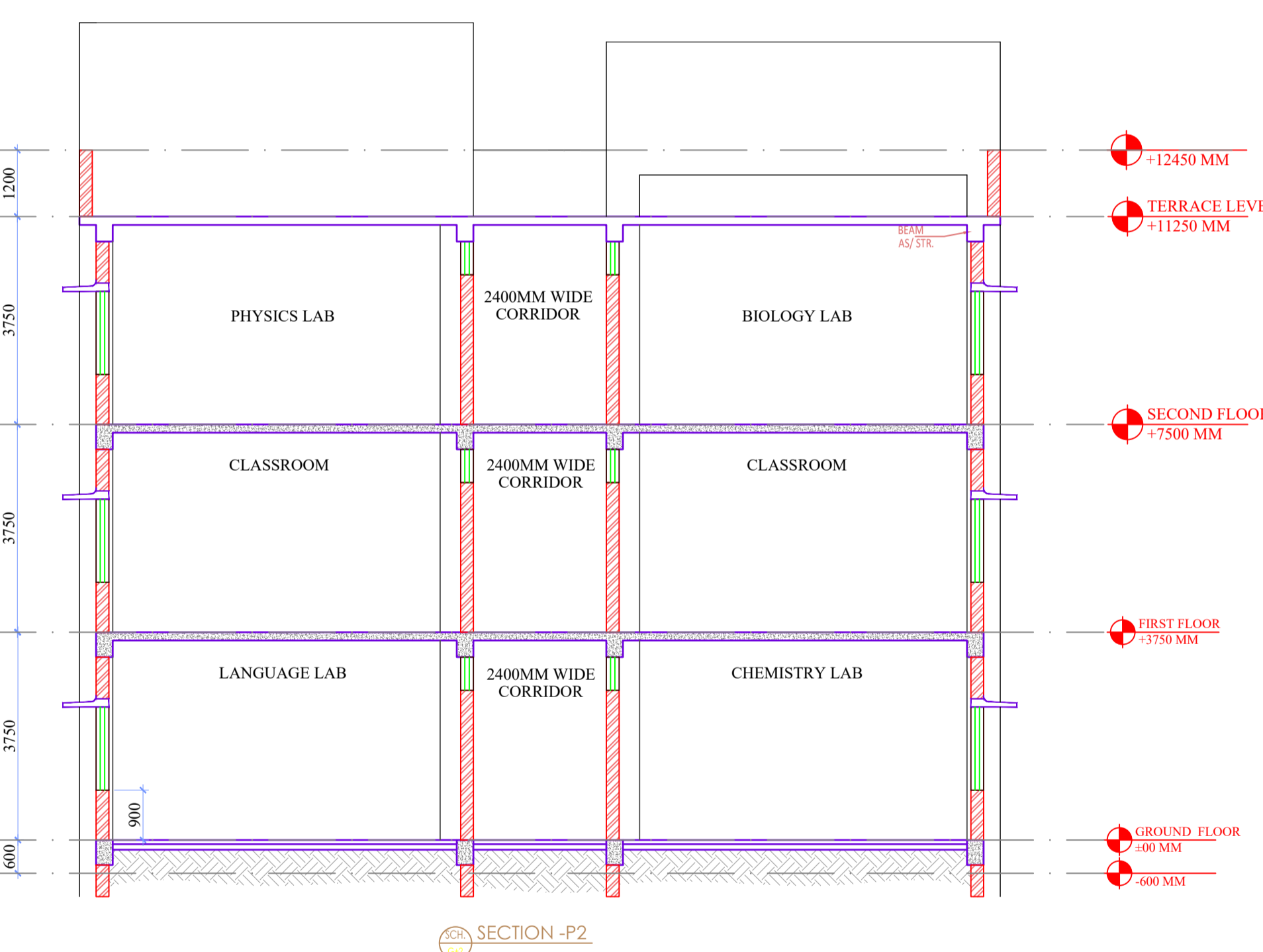
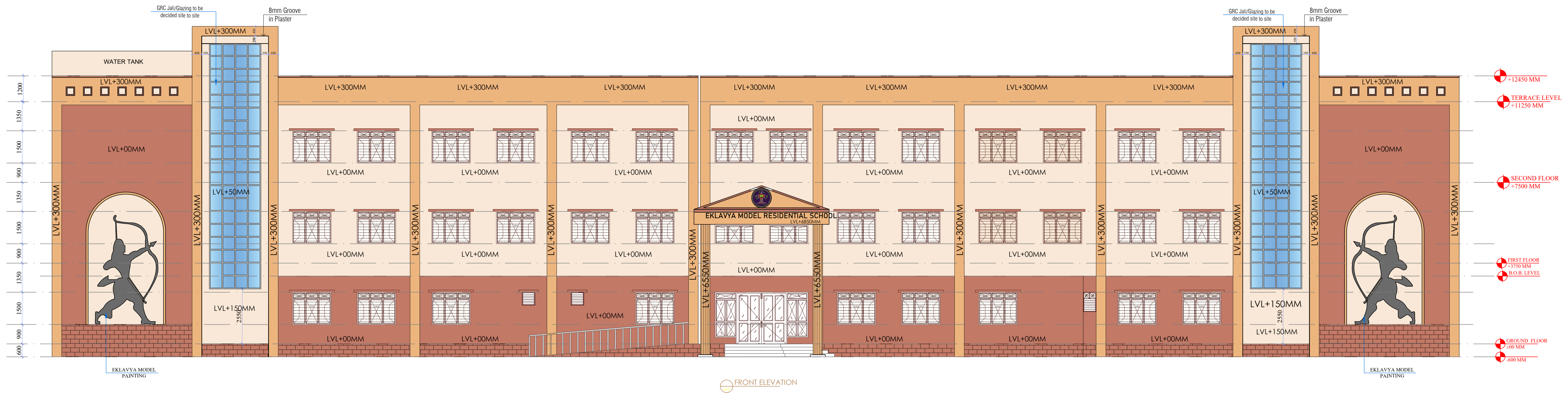

LAB STORE-
RCC SHELVES DETAIL

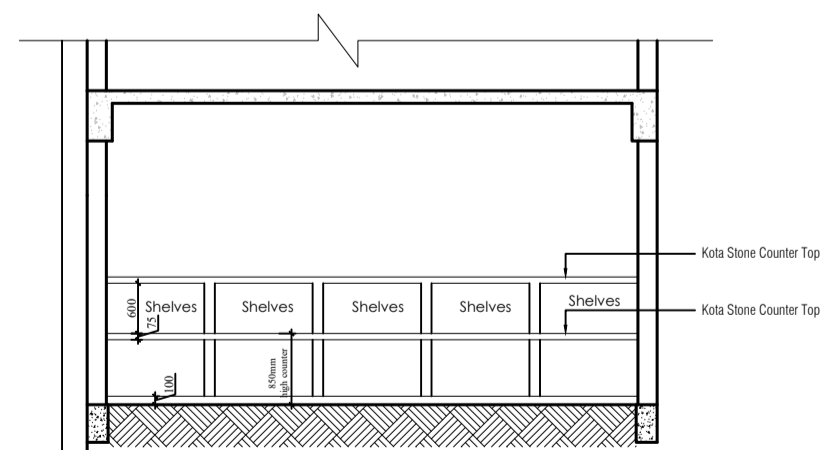

LAB RCC850MM HIGH COUNTER
WITH SHELF ABOVE-
RCC SHELVES DETAIL

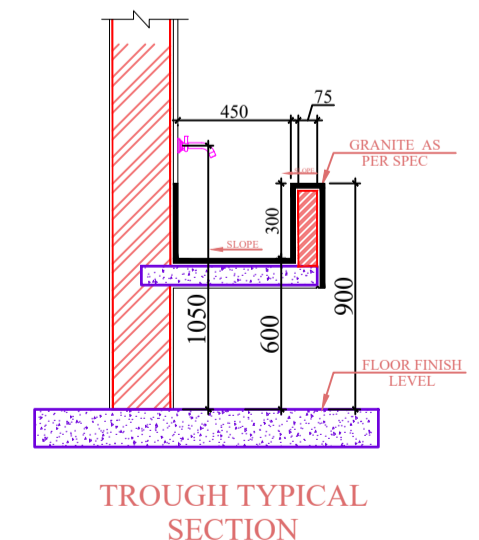

TROUGH TYPICAL
SECTION

DATE - 09 MARCH 2023

DWG. NO.-
EMRS NAME/SCH/AR_05

SCHOOL
ELEVATION, SECTION

SCALE:

MINISTRY OF TRIBAL AFFAIRS
NATIONAL EDUCATION SOCIETY FOR TRIBAL STUDENTS (NESTS)

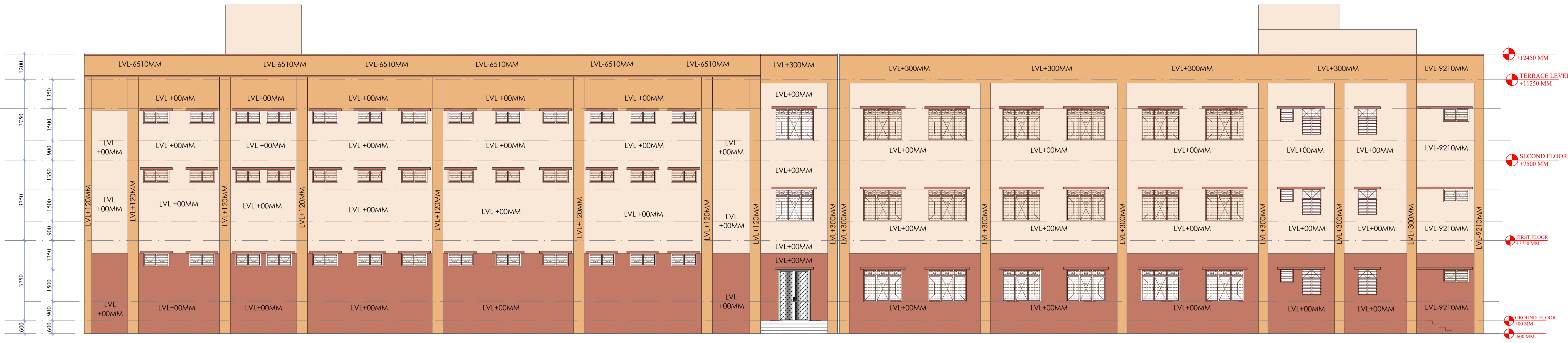

REAR ELEVATION

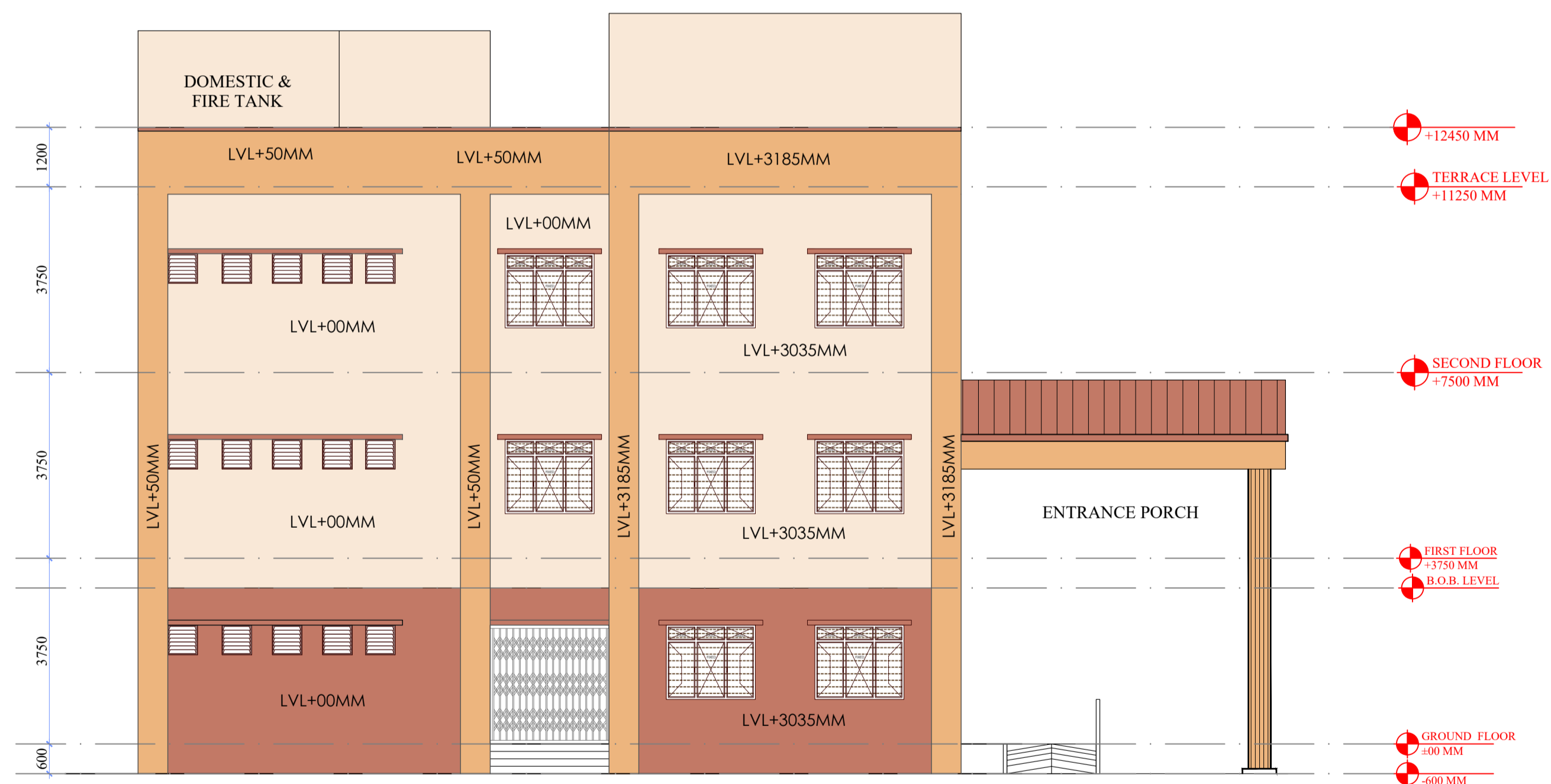

SIDE ELEVATION

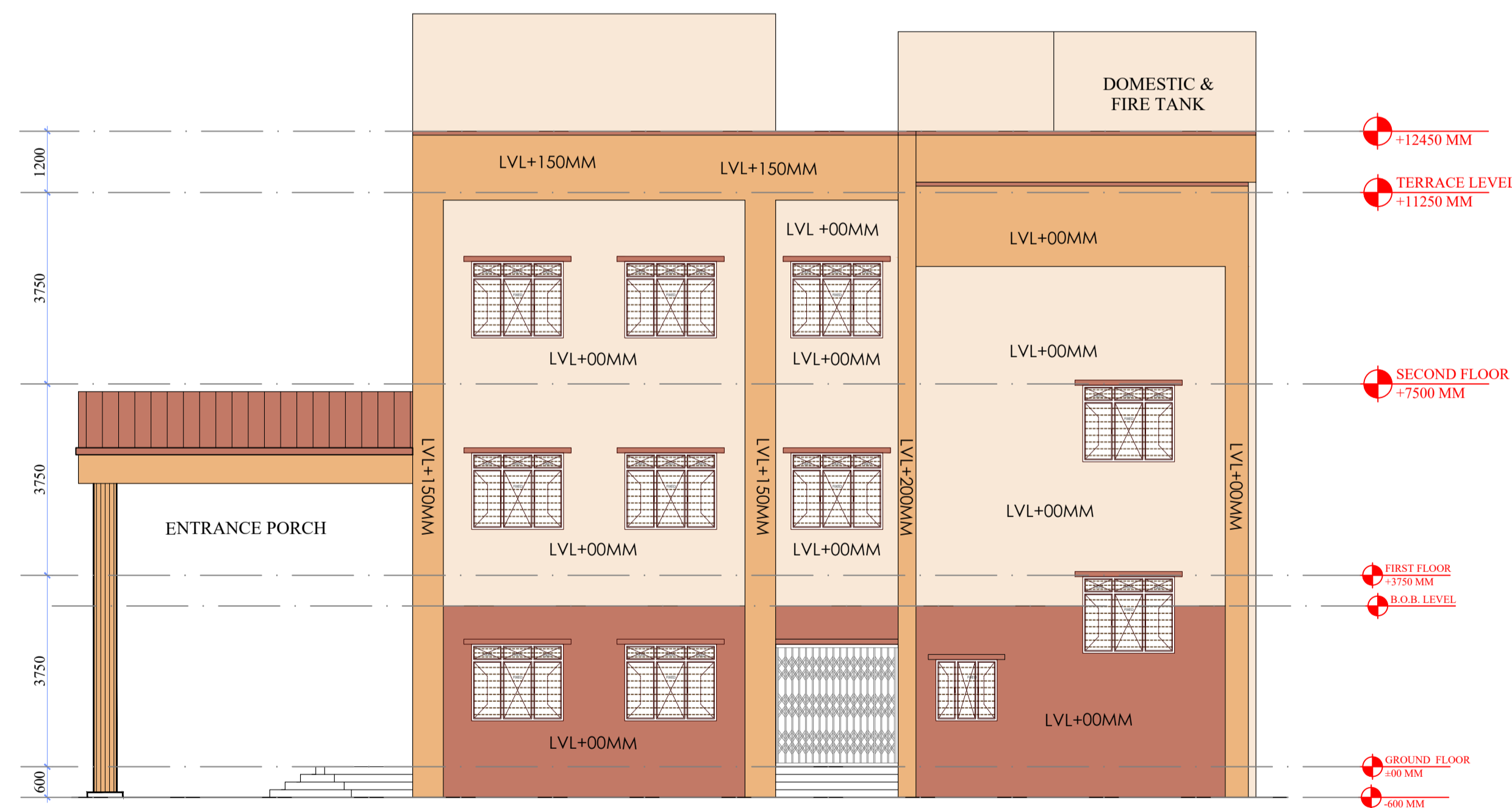

SIDE ELEVATION

DATE - 09 MARCH 2023

DWG. NO.-
EMRS NAME/SCH/AR_06

SCALE:

MINISTRY OF TRIBAL AFFAIRS
NATIONAL EDUCATION SOCIETY FOR TRIBAL STUDENTS (NESTS)

SCHOOL
ELEVATION, SECTION



| AREA STATEMENT | | | |
|--------------------------|---------------------|----------------------|---------------------|
| HOSTEL BUILDING | | | |
| DETAILS | Phase-I (in Sqm) | Phase-II (in Sqm) | TOTAL FLOOR AREA |
| MAIN BUILDING | 583.12 | 584.81 | 1167.93 |
| GROUND FLOOR PLINTH AREA | 574.55 | 574.55 | 1149.10 |
| FIRST FLOOR PLINTH AREA | 574.55 | 574.55 | 1149.10 |
| TOTAL AREA | 1157.67 | 1159.36 | 2317.03 |
| ENTRANCE PORCH AREA | | | |
| AREA / 2 | | | 12.76 |
| Total | | | 2330.00 |

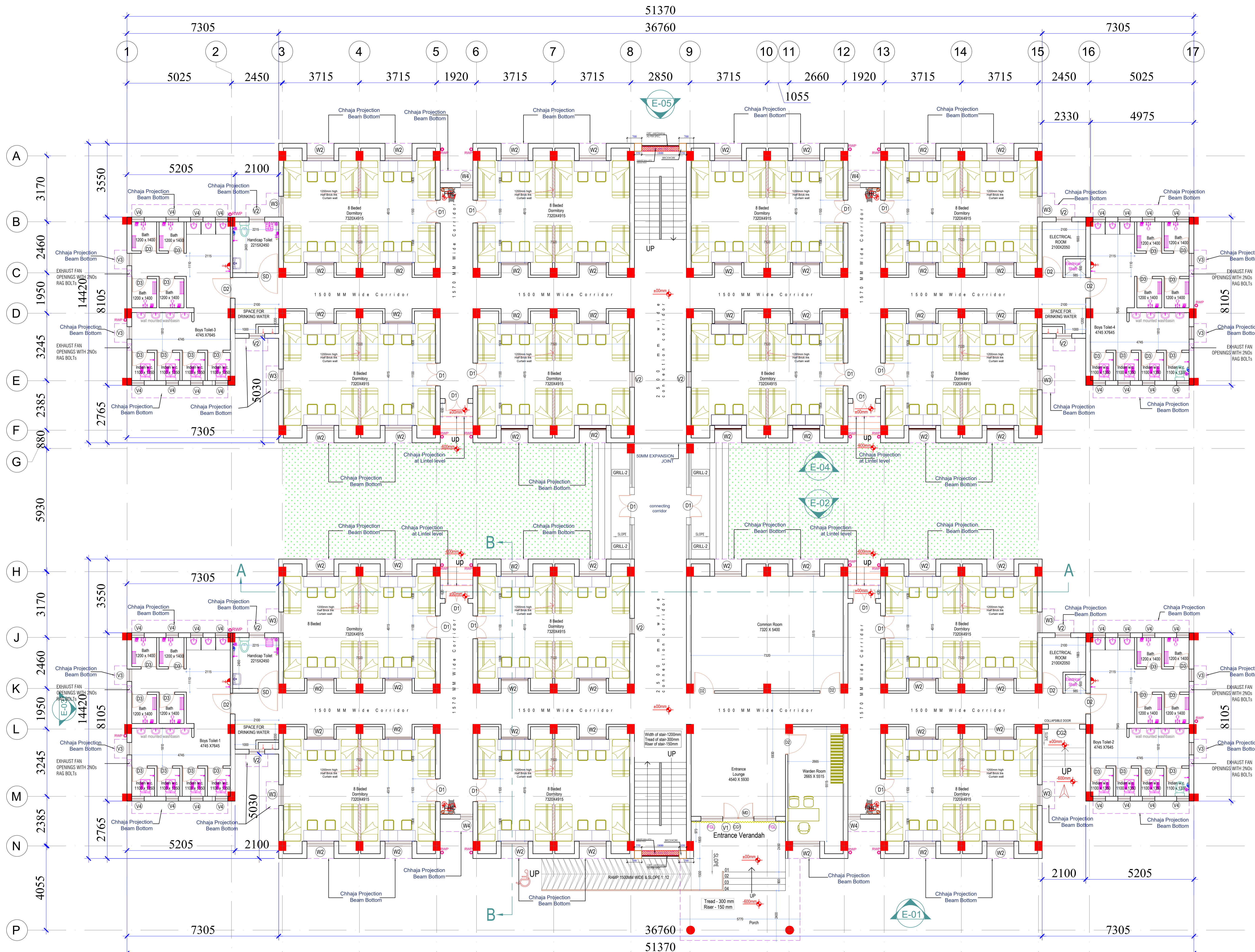

GROUND FLOOR PLAN ±00mm

CATEGORY : BOYS HOSTEL

DRAWING TITLE : GROUND FLOOR PLAN

DWG. NO.-
EMRS NAME/BH/AR_01

DATE - 09 MARCH 2023



51370
36760
51370
FIRST FLOOR PLAN +3300mm

CATEGORY : BOYS HOSTEL

DRAWING TITLE : FIRST FLOOR PLAN

DWG. NO.-
EMRS NAME/BH/AR_02

DATE - 09 MARCH 2023

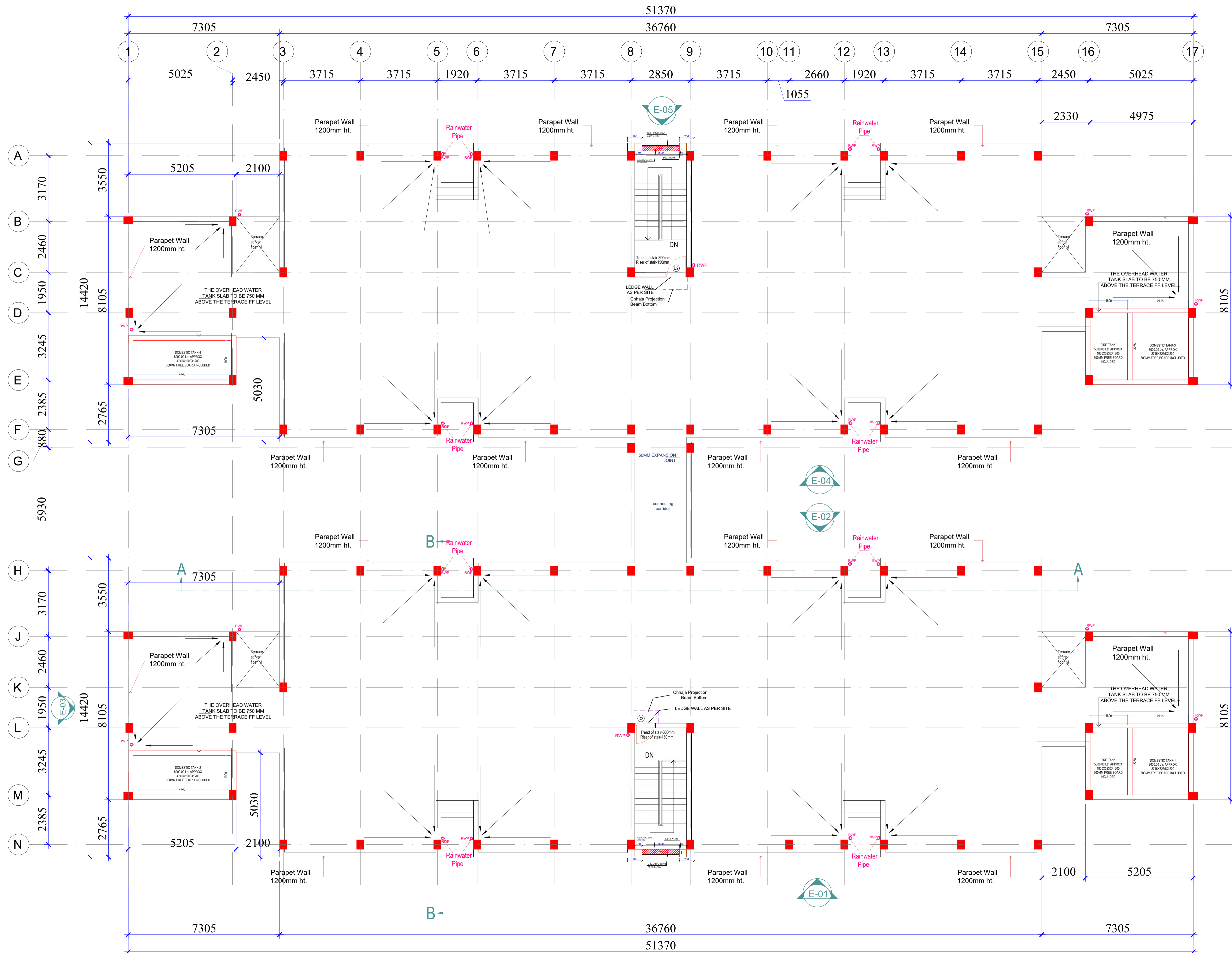
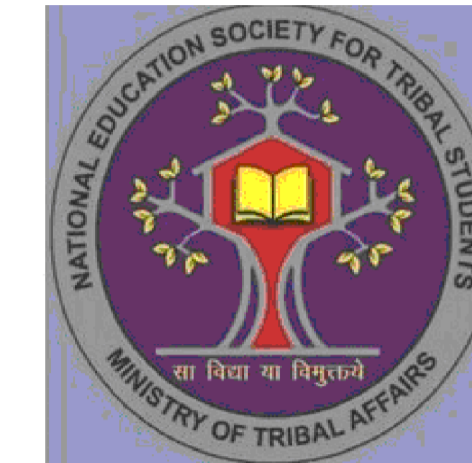

TERRACE FLOOR PLAN +6600 mm

CATEGORY : BOYS HOSTEL

DRAWING TITLE : TERRACE FLOOR PLAN

DWG. NO.-
EMRS NAME/BH/AR_03

DATE - 09 MARCH 2023

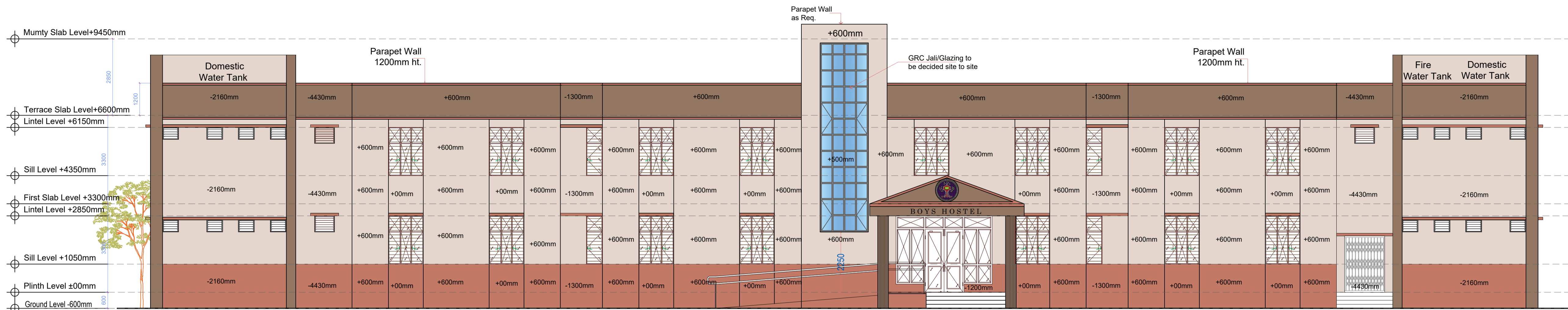

FRONT ELEVATION E-01

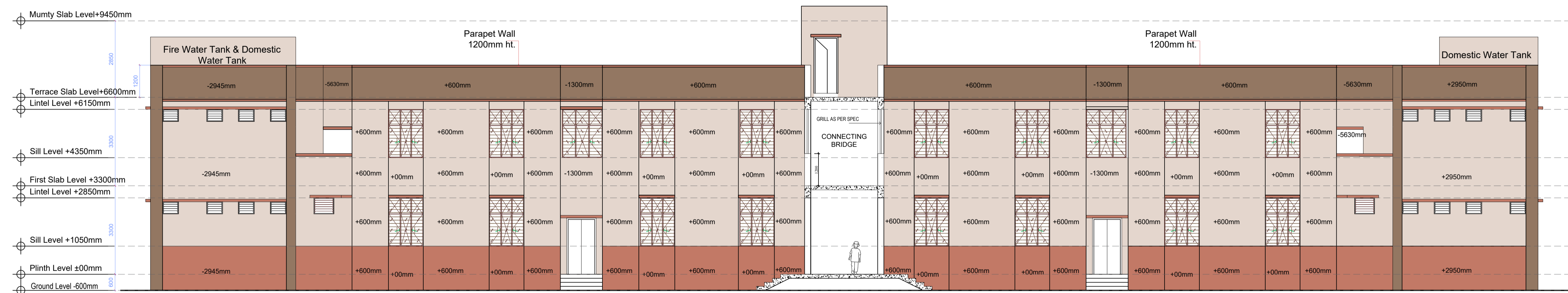

REAR SIDE ELEVATION E-02

| BOYS HOSTEL BUILDING | | | | | | | | | | |
|--|--------------------|------|--------|----|----|-------|-------|---------------------------------------|------------------|--------------------------------|
| DOOR, WINDOW, VENTILATOR, FIXED GLAZING SCHEDULE | | | | | | | | | | |
| TAG | CLEAR OPENING SIZE | SILL | LINTEL | GF | FF | MUMTY | TOTAL | LOCATION | TYPE OF SHUTTERS | MATERIAL |
| MD | 1500X2400 | 0 | 2400 | 1 | | | 1 | MAIN ENTRANCE DOOR | DOUBLE SHUTTER | ALUMINIUM |
| D1 | 1100X2100 | 0 | 2100 | 20 | 16 | | 36 | DORMITORY, CORRIDOR EXITS | DOUBLE SHUTTER | FLUSH DOOR |
| D2 | 1000 X 2100 | 0 | 2100 | 5 | 4 | | 9 | ELECTRICAL ROOM, COMMON ROOM & WARDEN | SINGLE SHUTTER | FLUSH DOOR |
| D2 | 1000 X 2100 | 0 | 2100 | 4 | 4 | | 8 | TOILET MAIN ENTRY | SINGLE SHUTTER | FACTORY PRESSED LAMINATED DOOR |
| D2 | 1000 X 2100 | 0 | 2100 | | | 2 | 2 | TERRACE DOOR | SINGLE SHUTTER | MS SHEET DOOR |
| D3 | 750 X 2100 | 0 | 2100 | 32 | 32 | | 64 | TOILET INTERNAL DOOR | SINGLE SHUTTER | FACTORY PRESSED LAMINATED DOOR |
| SD | 1000 X 2100 | 0 | 2100 | 2 | | | 2 | HANDICAP TOILET | DOUBLE SWING | FACTORY PRESSED LAMINATED DOOR |
| CG1 | 4540X2400 | 0 | 2400 | 1 | | | 1 | MAIN ENTRY | | COLLAPSIBLE GATE |
| CG2 | 2100X2100 | 0 | 2100 | 1 | | | 1 | WARDEN ENTRY | | COLLAPSIBLE GATE |
| W1 | 1500X1800 | 1050 | B.O.B | | 4 | | 4 | CORRIDOR | FIXED & OPENABLE | STEEL GLAZED WINDOW |
| W2 | 1300X1800 | 1050 | B.O.B | 59 | 64 | | 123 | DORMITORY, CORRIDOR, WARDEN ROOM | FIXED & OPENABLE | STEEL GLAZED WINDOW |
| W3 | 1000X1800 | 1050 | B.O.B | 8 | 8 | | 16 | DORMITORY | FIXED & OPENABLE | STEEL GLAZED WINDOW |
| W4 | 600X1800 | 1050 | B.O.B | 4 | 4 | | 8 | VERTICAL CORRIDOR | FIXED & OPENABLE | STEEL GLAZED WINDOW |
| V1 | 1500X450 | 2400 | B.O.B | 1 | | | 1 | MAIN ENTRANCE | | ALUMINIUM FIXED GLAZING |
| V2 | 750X600 | 2250 | B.O.B | 10 | 8 | | 18 | TOILET, DRINKING WATER, SERVICE AREA | | STEEL SECTION |
| V3 | 600X1200 | 1050 | B.O.B | 8 | 8 | | 16 | TOILET | | STEEL SECTION |
| V4 | 600X450 | | B.O.B | 32 | 32 | | 64 | TOILET | | STEEL SECTION |
| GRILL-1 | 5100X1650 | | B.O.B | | 2 | | 2 | CONNECTING CORRIDOR | | |
| GRILL-2 | 1650X1650 | | B.O.B | 4 | | | 4 | CONNECTING CORRIDOR | | |
| FGL | 1050 X 2550 | 300 | B.O.B | 2 | | | 2 | MAIN ENTRANCE | | ALUMINIUM FIXED GLAZING |

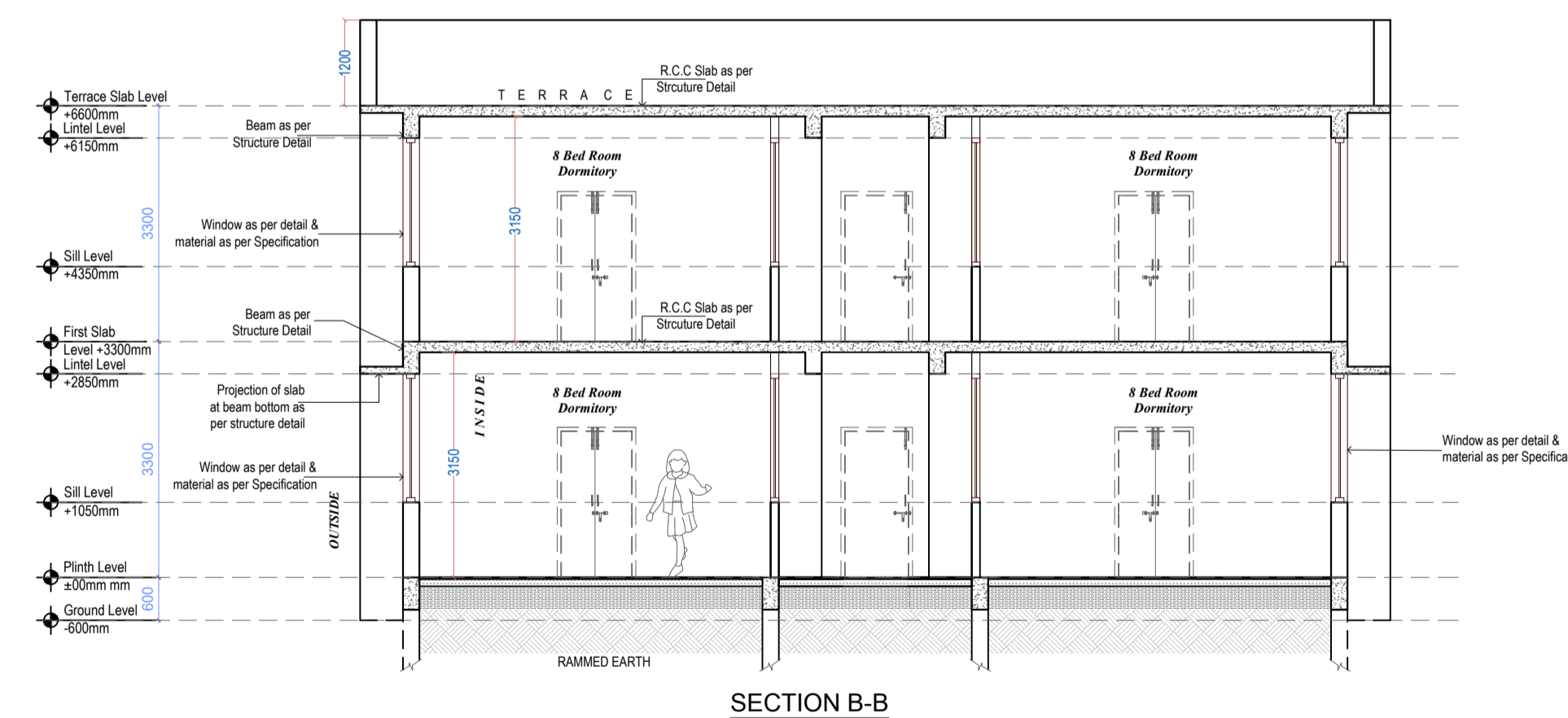

SECTION B-B

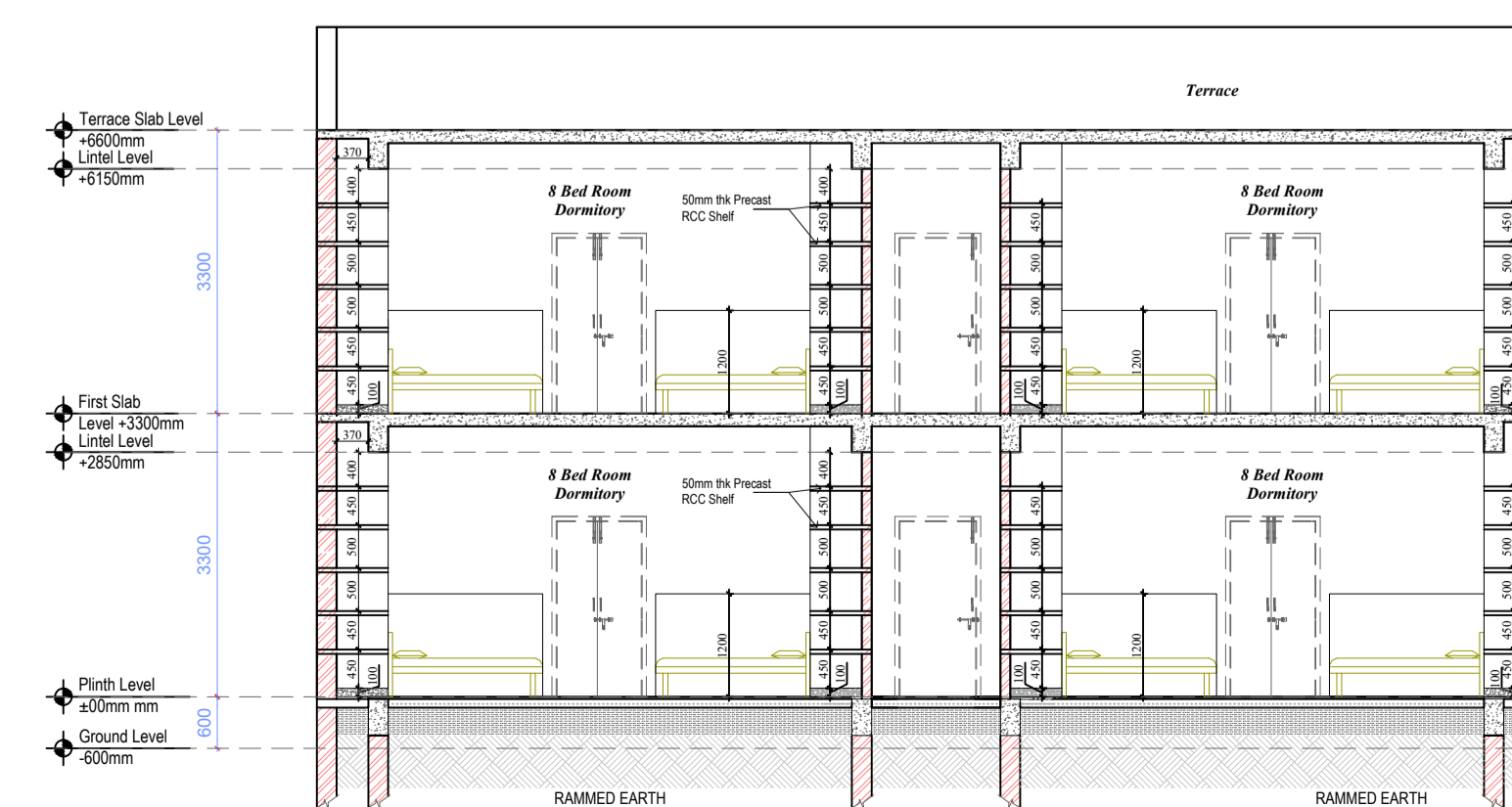

CATEGORY : BOYS HOSTEL

DRAWING TITLE : ELEVATION & SECTION

DWG. NO.- EMRS NAME/BH/AR_04

DATE - 09 MARCH 2023

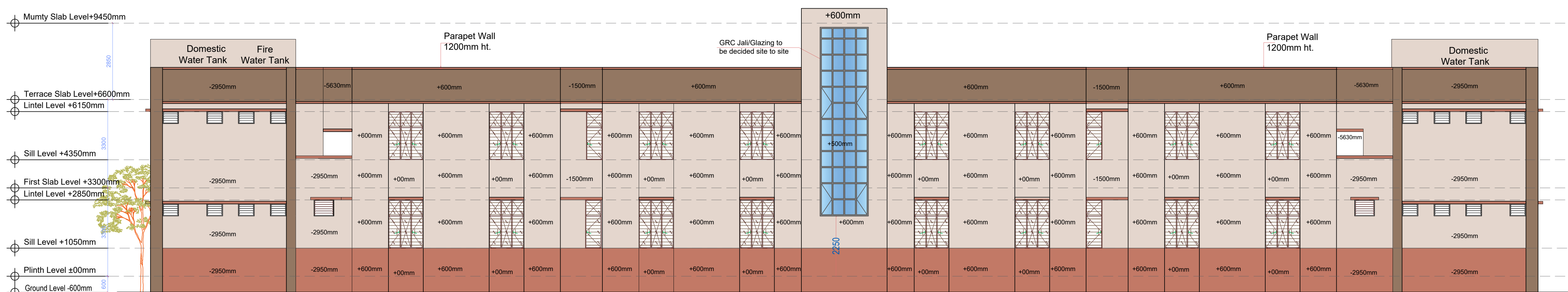

REAR ELEVATION E-05

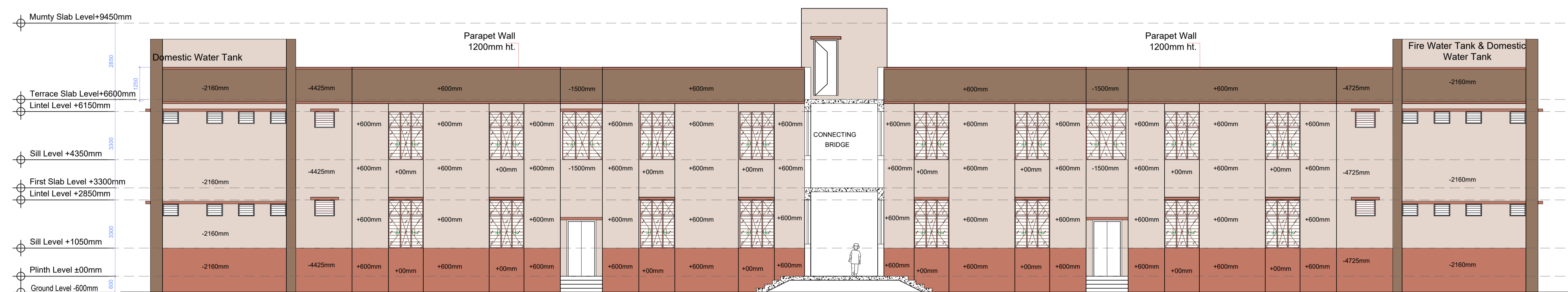

FRONT SIDE ELEVATION E-04

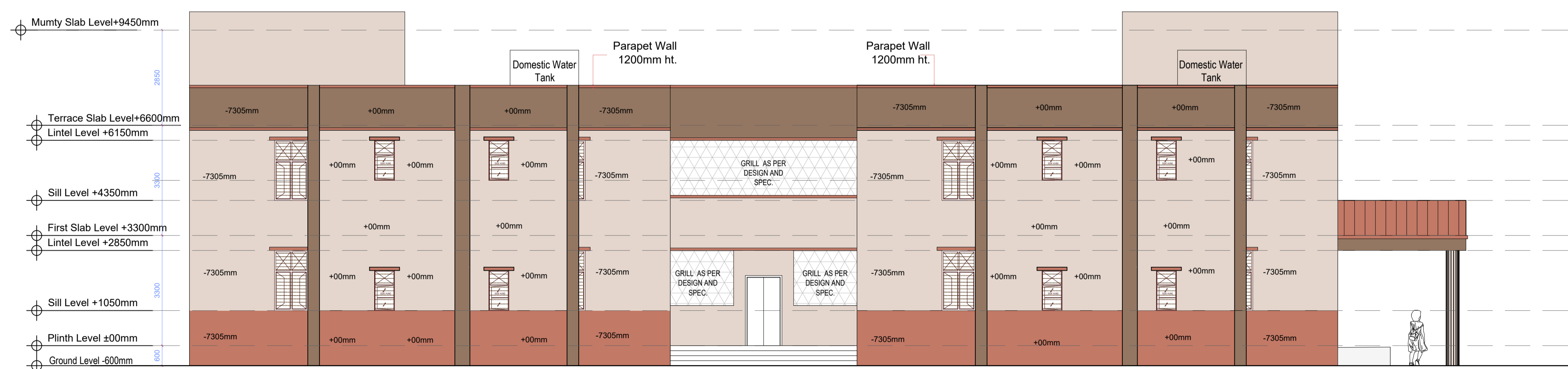

SIDE ELEVATION E-03

CATEGORY : BOYS HOSTEL

DRAWING TITLE : ELEVATION

DWG. NO.-
EMRS NAME/BH/AR_05

DATE - 09 MARCH 2023

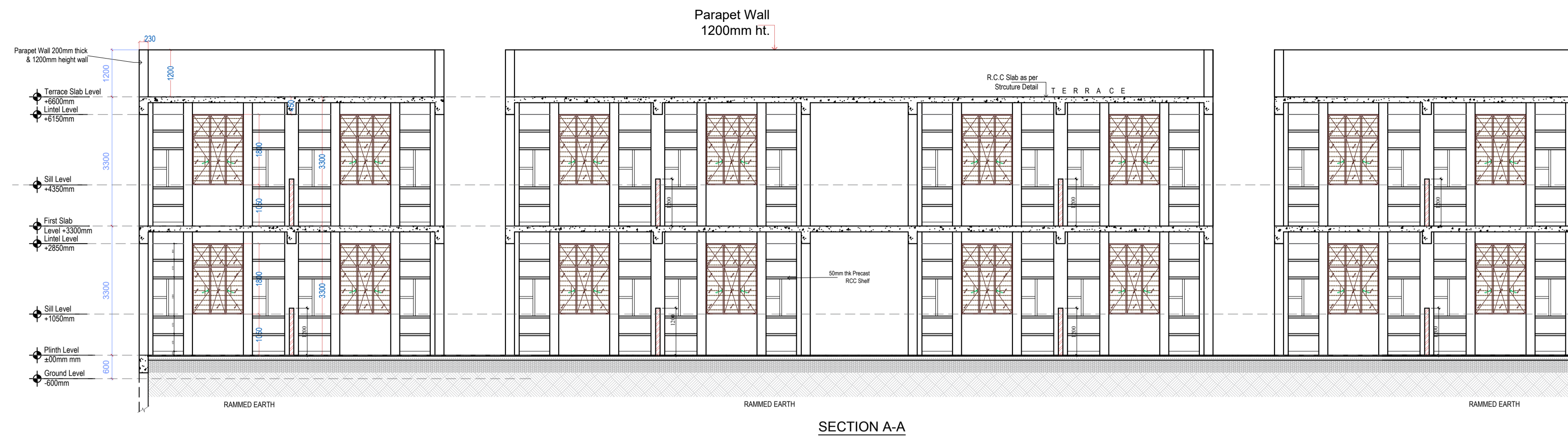

SECTION A-A

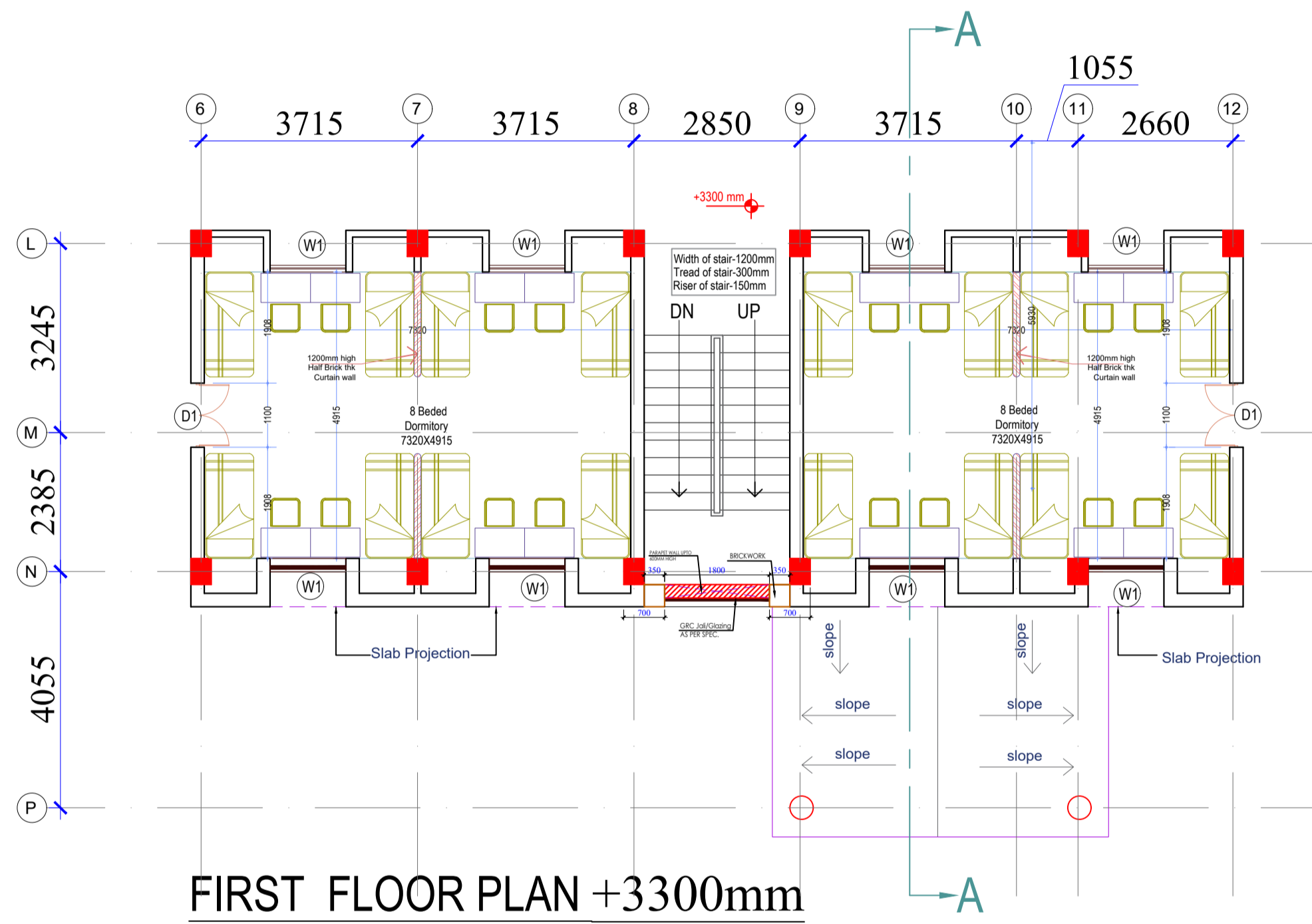

FIRST FLOOR PLAN +3300mm

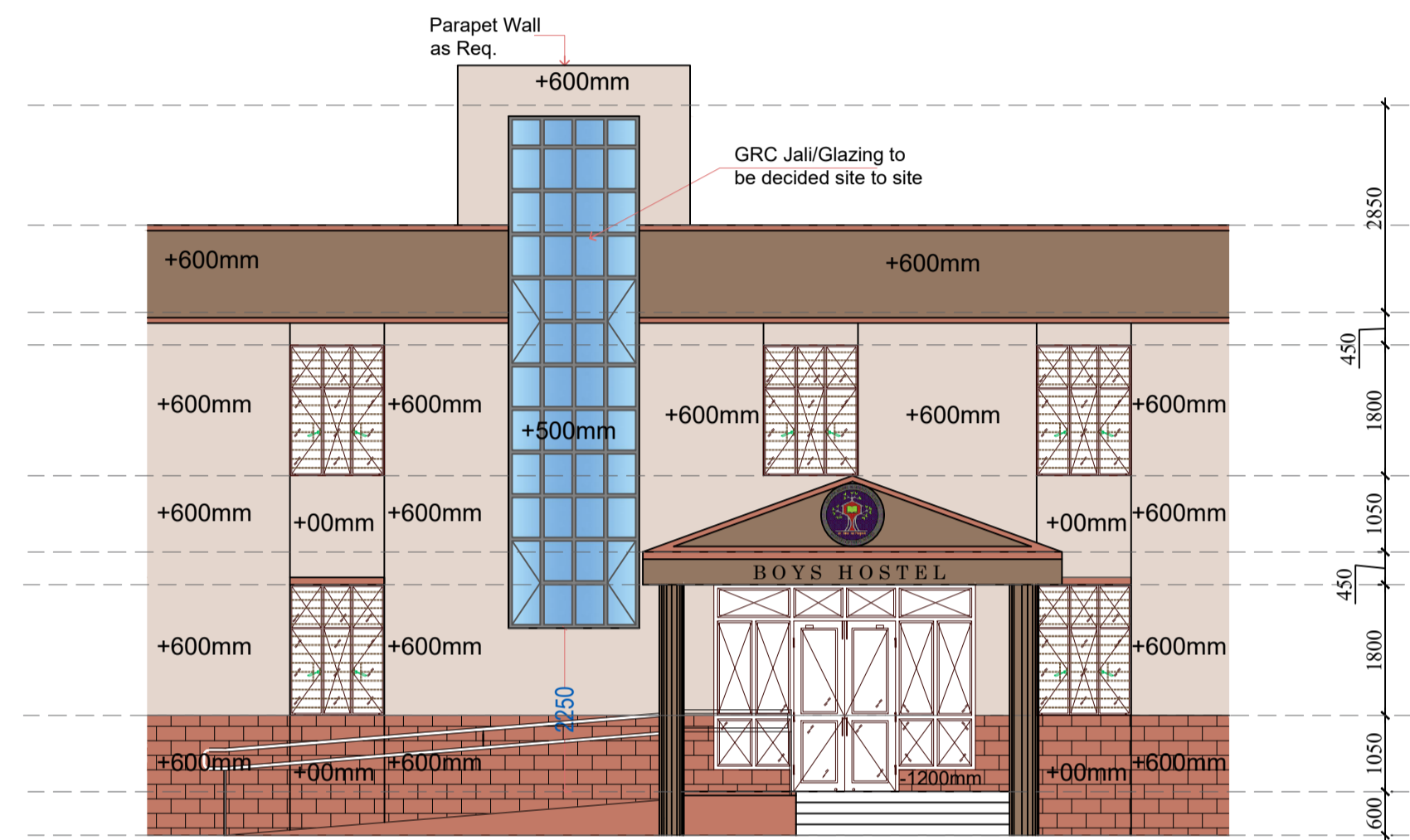
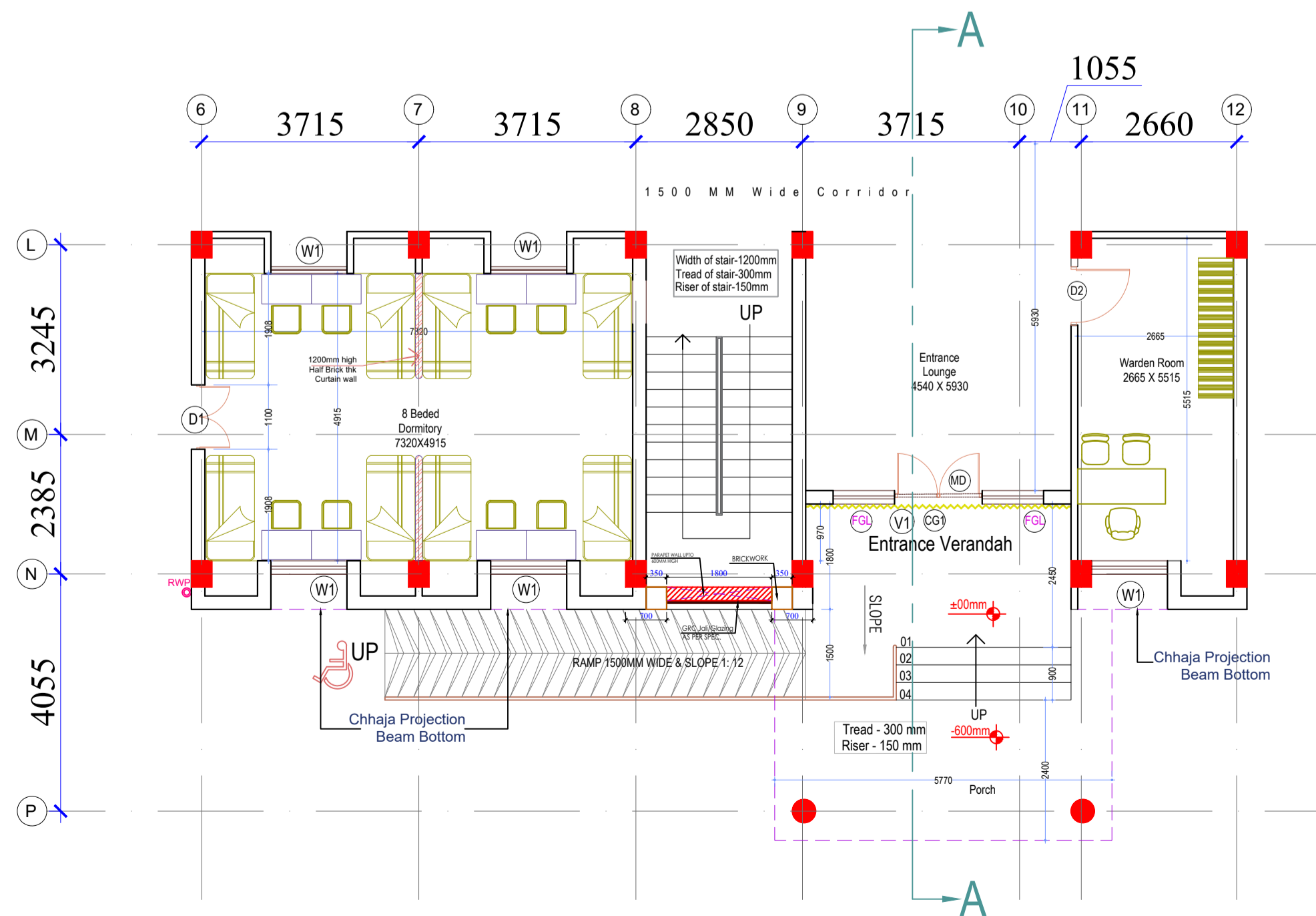

FRONT ELEVATION

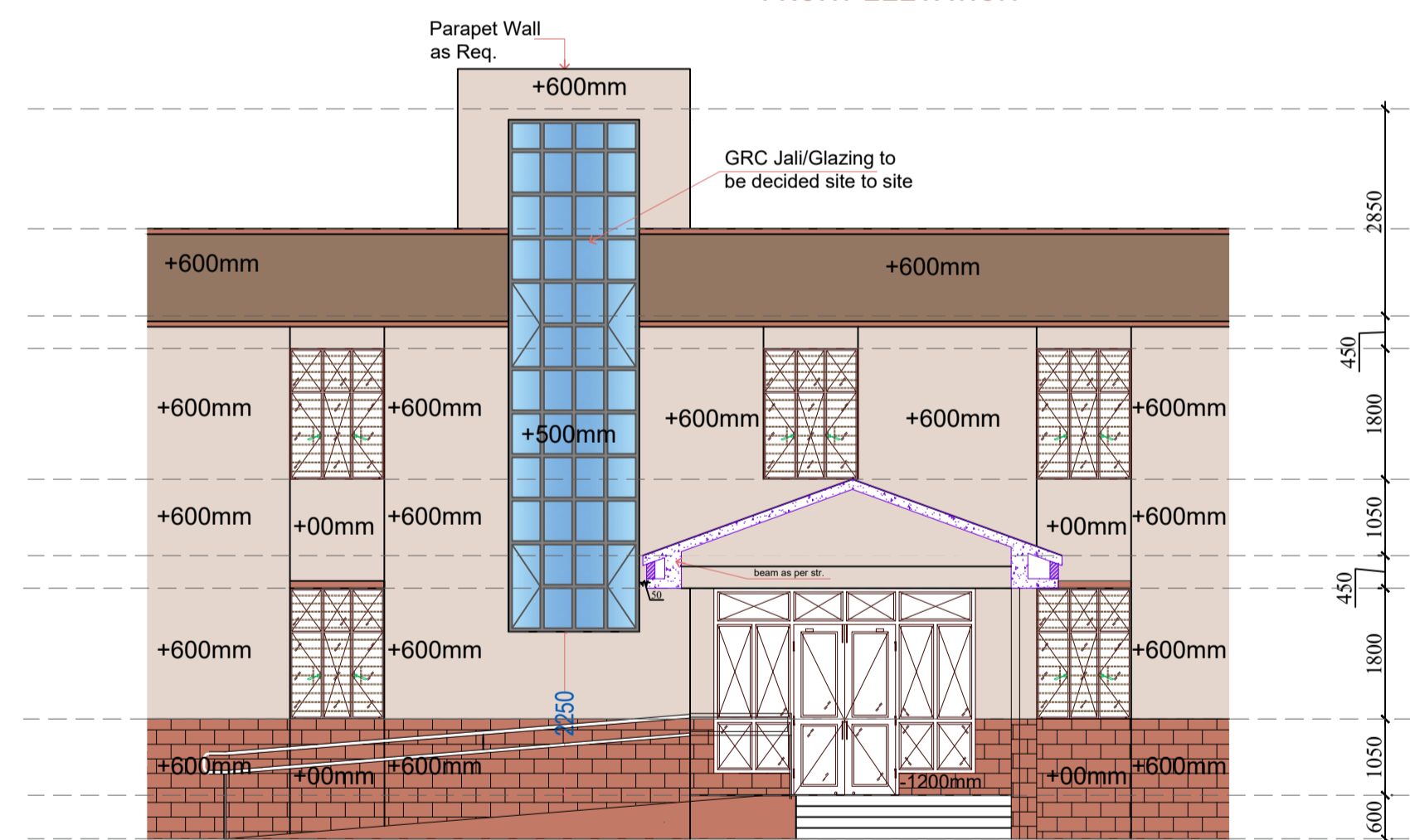

FRONT ELEVATION

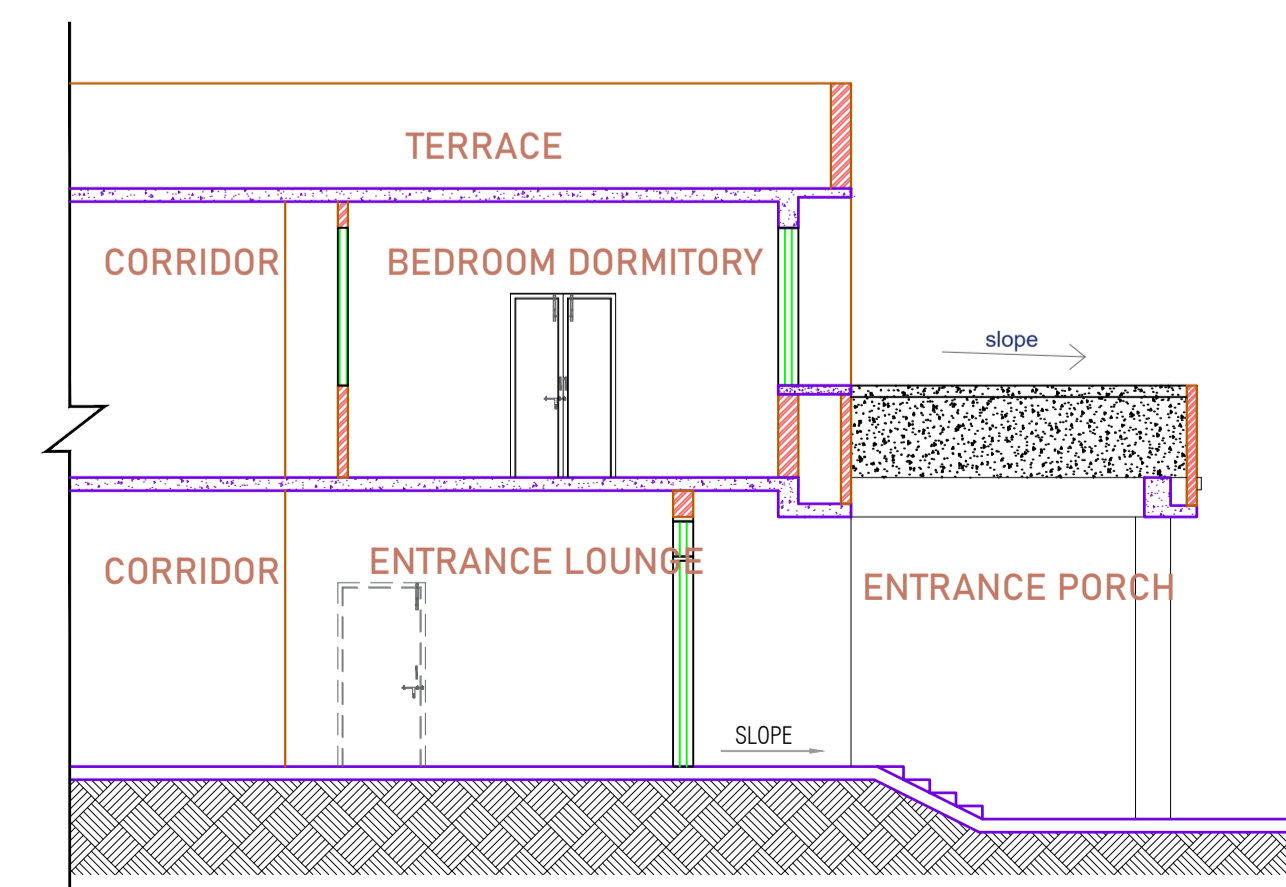

SECTIONAL VIEW A-A

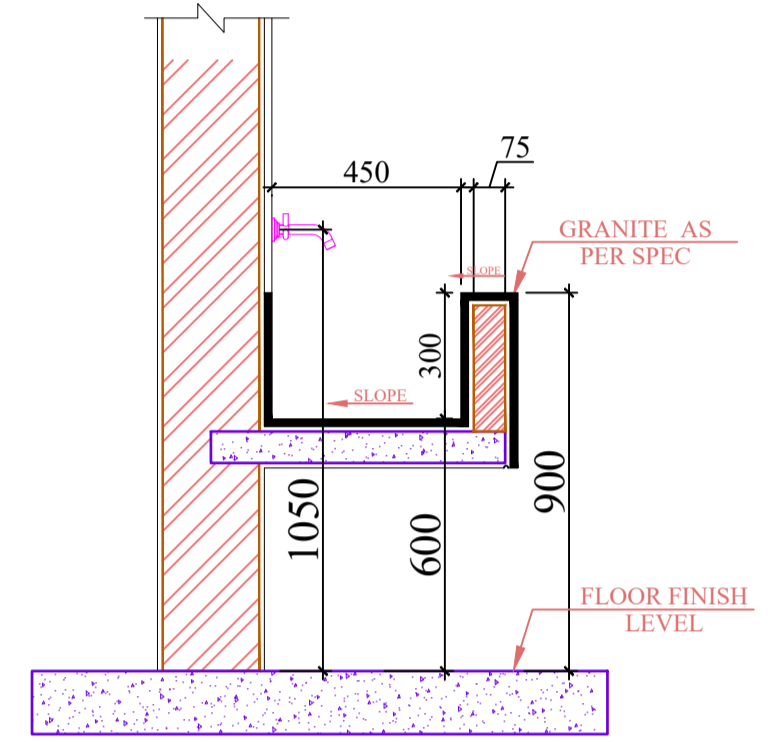

TROUGH TYPICAL SECTION

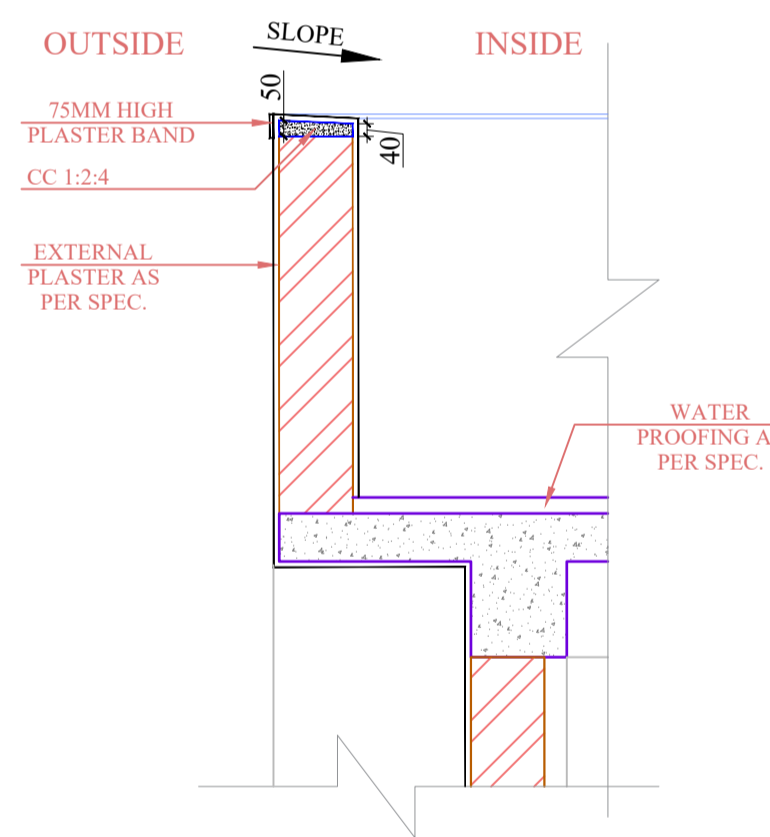

TERRACE PARAPET WALL TYPICAL COPING DETAIL

CATEGORY : BOYS HOSTEL

DRAWING TITLE : SECTION & PORCH DETAIL

DWG. NO.- EMRS NAME/BH/AR_06

DATE - 09 MARCH 2023



| AREA STATEMENT | | | |
|--------------------------|------------------|-------------------|------------------|
| HOSTEL BUILDING | | | |
| DETAILS | Phase-I (in Sqm) | Phase-II (in Sqm) | TOTAL FLOOR AREA |
| MAIN BUILDING | | | |
| GROUND FLOOR PLINTH AREA | 583.12 | 584.81 | 1167.93 |
| FIRST FLOOR PLINTH AREA | 574.55 | 574.55 | 1149.10 |
| TOTAL AREA | 1157.67 | 1159.36 | 2317.03 |
| ENTRANCE PORCH AREA | | | |
| AREA/2 | | | 12.76 |
| Total | | | 2330.00 |

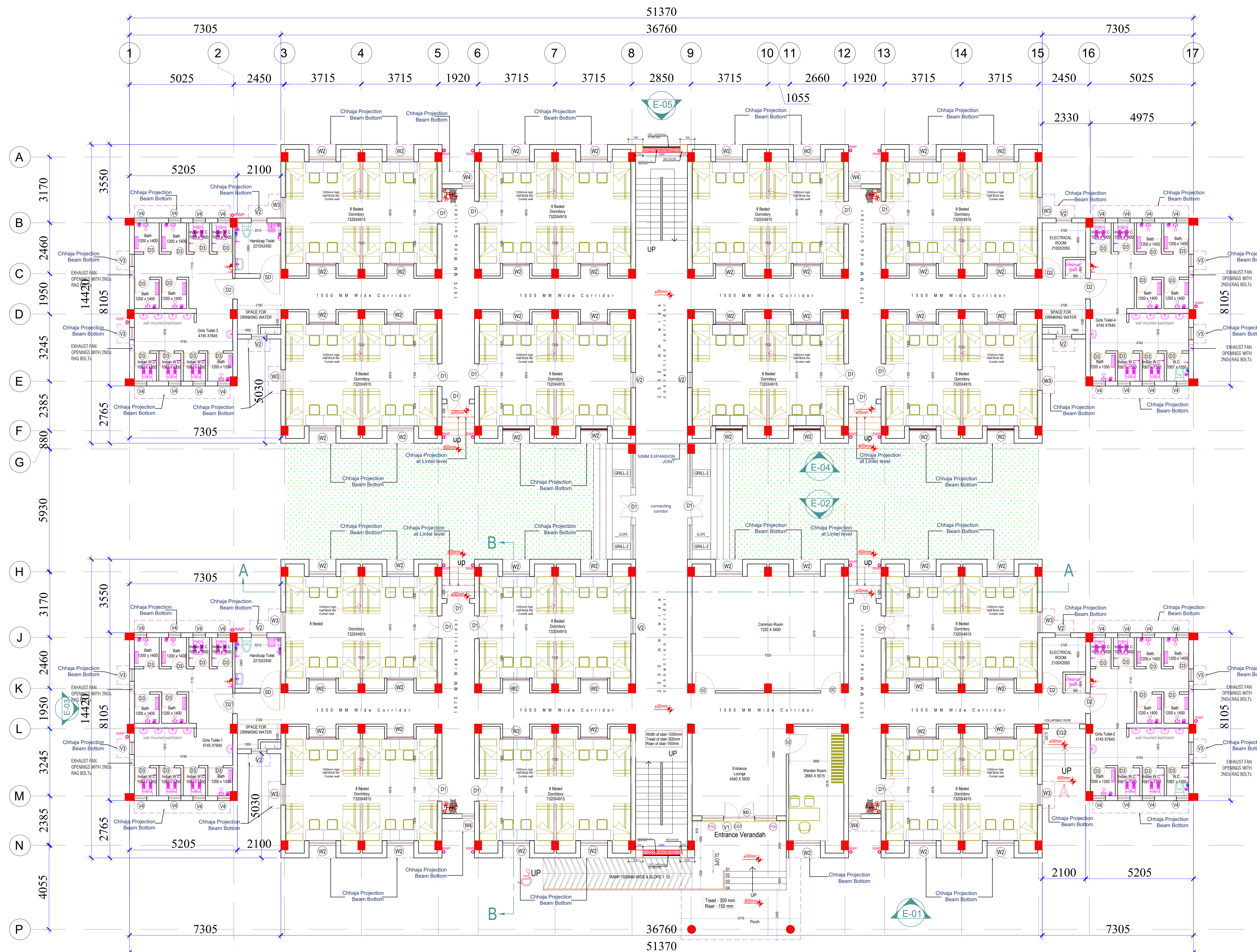

GROUND FLOOR PLAN ±00mm

CATEGORY : GIRLS HOSTEL

DRAWING TITLE : GROUND FLOOR PLAN

DWG. NO.- EMRS NAME/GH/AR_01

DATE - 09 MARCH 2023

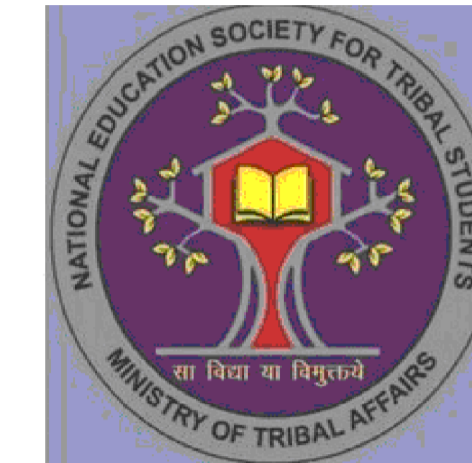

CATEGORY : GIRLS HOSTEL

DRAWING TITLE : FIRST FLOOR PLAN

DWG. NO.-
EMRS NAME/GH/AR_02

DATE - 09 MARCH 2023

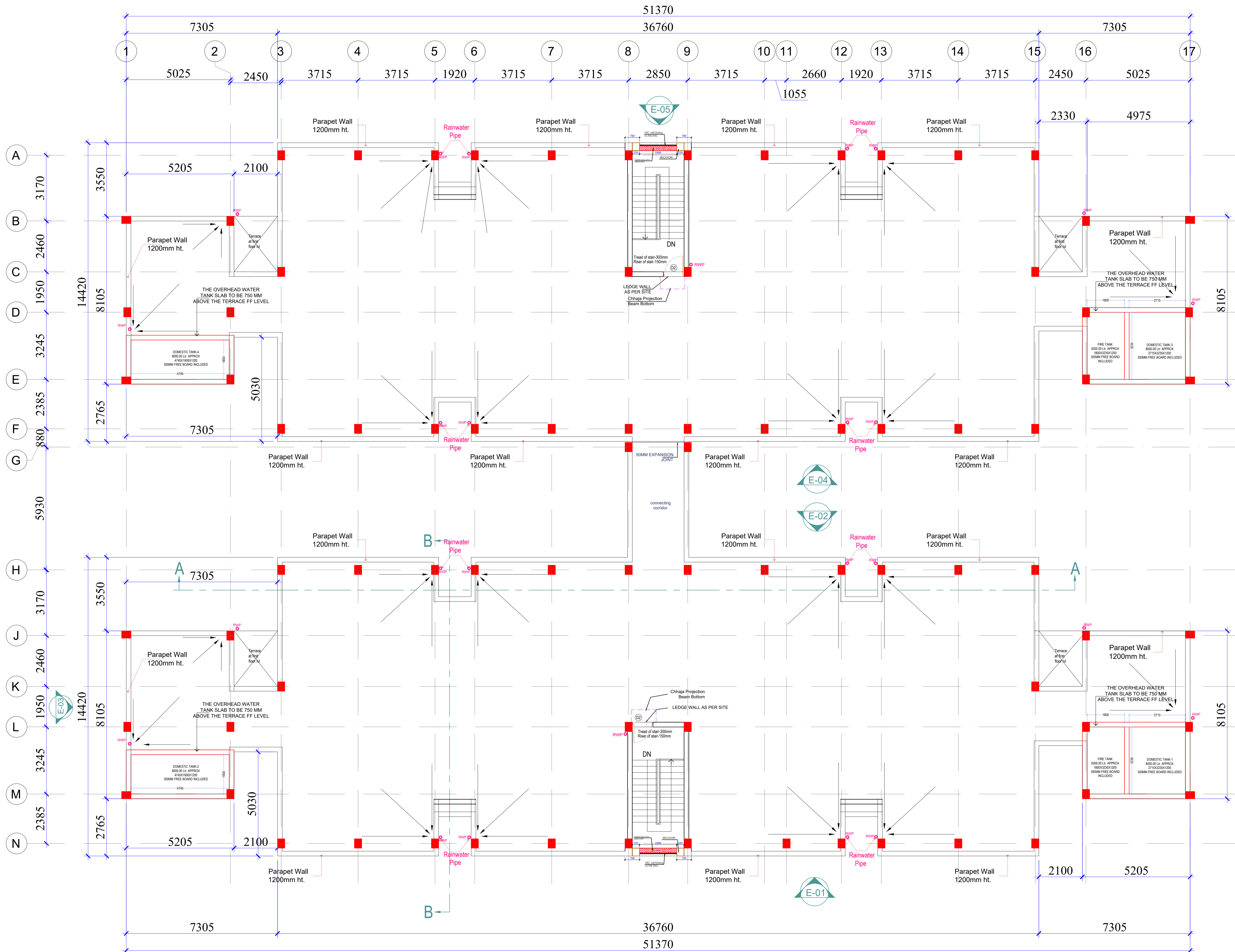

TERRACE FLOOR PLAN +6600 mm

CATEGORY : GIRLS HOSTEL

DRAWING TITLE : TERRACE FLOOR PLAN

DWG. NO.- EMRS NAME/GH/AR_03

DATE - 09 MARCH 2023

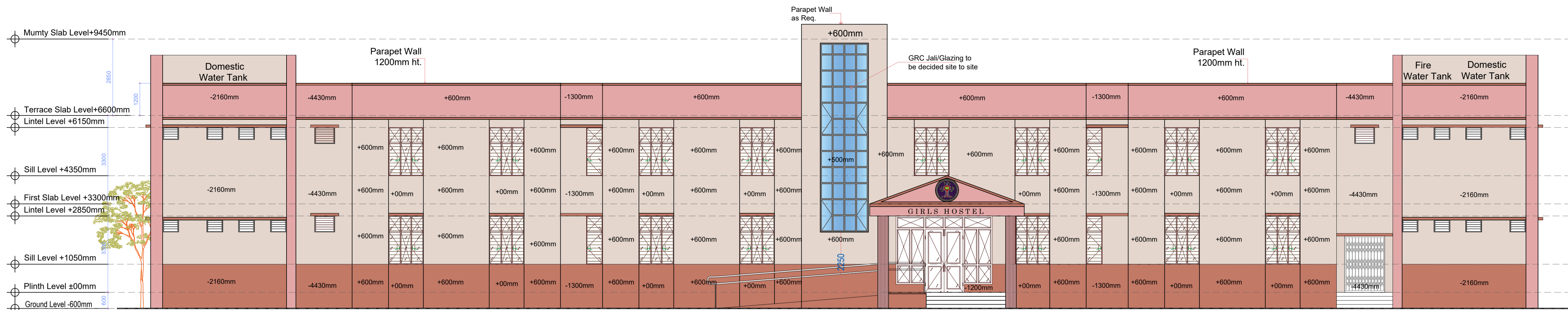

FRONT ELEVATION E-01

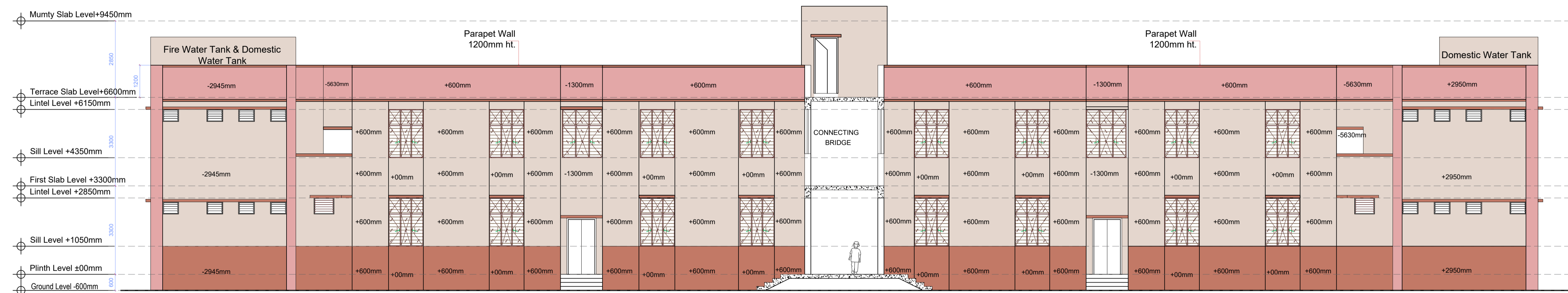

REAR SIDE ELEVATION E-02

| GIRLS HOSTEL BUILDING | | | | | | | | | | |
|--|--------------------|------|--------|----|----|-------|-------|---------------------------------------|------------------|--------------------------------|
| DOOR, WINDOW, VENTILATOR, FIXED GLAZING SCHEDULE | | | | | | | | | | |
| TAG | CLEAR OPENING SIZE | SILL | LINTEL | GF | FF | MUMTY | TOTAL | LOCATION | TYPE OF SHUTTERS | MATERIAL |
| MD | 1500X2400 | 0 | 2400 | 1 | | | 1 | MAIN ENTRANCE DOOR | DOUBLE SHUTTER | ALUMINIUM |
| D1 | 1100X2100 | 0 | 2100 | 20 | 16 | | 36 | DORMITORY, CORRIDOR EXITS | DOUBLE SHUTTER | FLUSH DOOR |
| D2 | 1000 X 2100 | 0 | 2100 | 5 | 4 | | 9 | ELECTRICAL ROOM, COMMON ROOM & WARDEN | SINGLE SHUTTER | FLUSH DOOR |
| D2 | 1000 X 2100 | 0 | 2100 | 4 | 4 | | 8 | TOILET MAIN ENTRY | SINGLE SHUTTER | FACTORY PRESSED LAMINATED DOOR |
| D2 | 1000 X 2100 | 0 | 2100 | | | 2 | 2 | TERRACE DOOR | SINGLE SHUTTER | MS SHEET DOOR |
| D3 | 750 X 2100 | 0 | 2100 | 40 | 40 | | 80 | TOILET INTERNAL DOOR | SINGLE SHUTTER | FACTORY PRESSED LAMINATED DOOR |
| SD | 1000 X 2100 | 0 | 2100 | 2 | | | 2 | HANDICAP TOILET | DOUBLE SWING | FACTORY PRESSED LAMINATED DOOR |
| CG1 | 4540X2400 | 0 | 2400 | 1 | | | 1 | MAIN ENTRY | | COLLAPSIBLE GATE |
| CG2 | 2100X2100 | 0 | 2100 | 1 | | | 1 | WARDEN ENTRY | | COLLAPSIBLE GATE |
| W1 | 1500X1800 | 1050 | B.O.B | | 4 | | 4 | CORRIDOR | FIXED & OPENABLE | STEEL GLAZED WINDOW |
| W2 | 1300X1800 | 1050 | B.O.B | 59 | 64 | | 123 | DORMITORY, CORRIDOR, WARDEN ROOM | FIXED & OPENABLE | STEEL GLAZED WINDOW |
| W3 | 1000X1800 | 1050 | B.O.B | 8 | 8 | | 16 | DORMITORY | FIXED & OPENABLE | STEEL GLAZED WINDOW |
| W4 | 600X1800 | 1050 | B.O.B | 4 | 4 | | 8 | DORMITORY | FIXED & OPENABLE | STEEL GLAZED WINDOW |
| V1 | 1500X450 | 2400 | B.O.B | 1 | | | 1 | MAIN ENTRANCE | | ALUMINIUM FIXED GLAZING |
| V2 | 750X600 | 2250 | B.O.B | 10 | 8 | | 18 | TOILET, DRINKING WATER, SERVICE AREA | | STEEL SECTION |
| V3 | 600X1200 | 1050 | B.O.B | 8 | 8 | | 16 | TOILET, VERTICAL CORRIDOR | | STEEL SECTION |
| V4 | 600X450 | | B.O.B | 32 | 32 | | 64 | TOILET | | STEEL SECTION |
| GRILL-1 | 5100X1650 | | B.O.B | | 2 | | 2 | CONNECTING CORRIDOR | | |
| GRILL-2 | 1650X1650 | | B.O.B | 4 | | | 4 | CONNECTING CORRIDOR | | |
| FGL | 1050 X 2550 | 300 | B.O.B | 2 | | | 2 | MAIN ENTRANCE | | ALUMINIUM FIXED GLAZING |

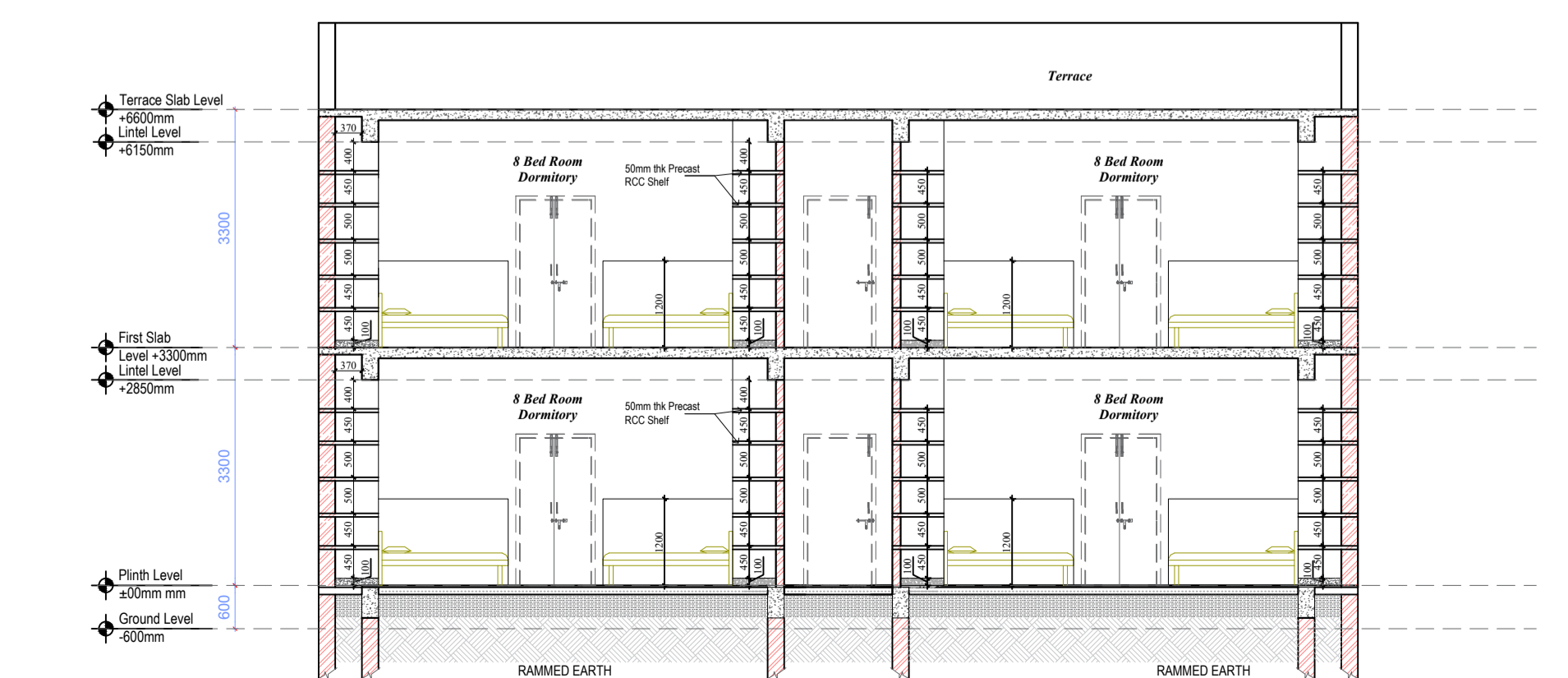
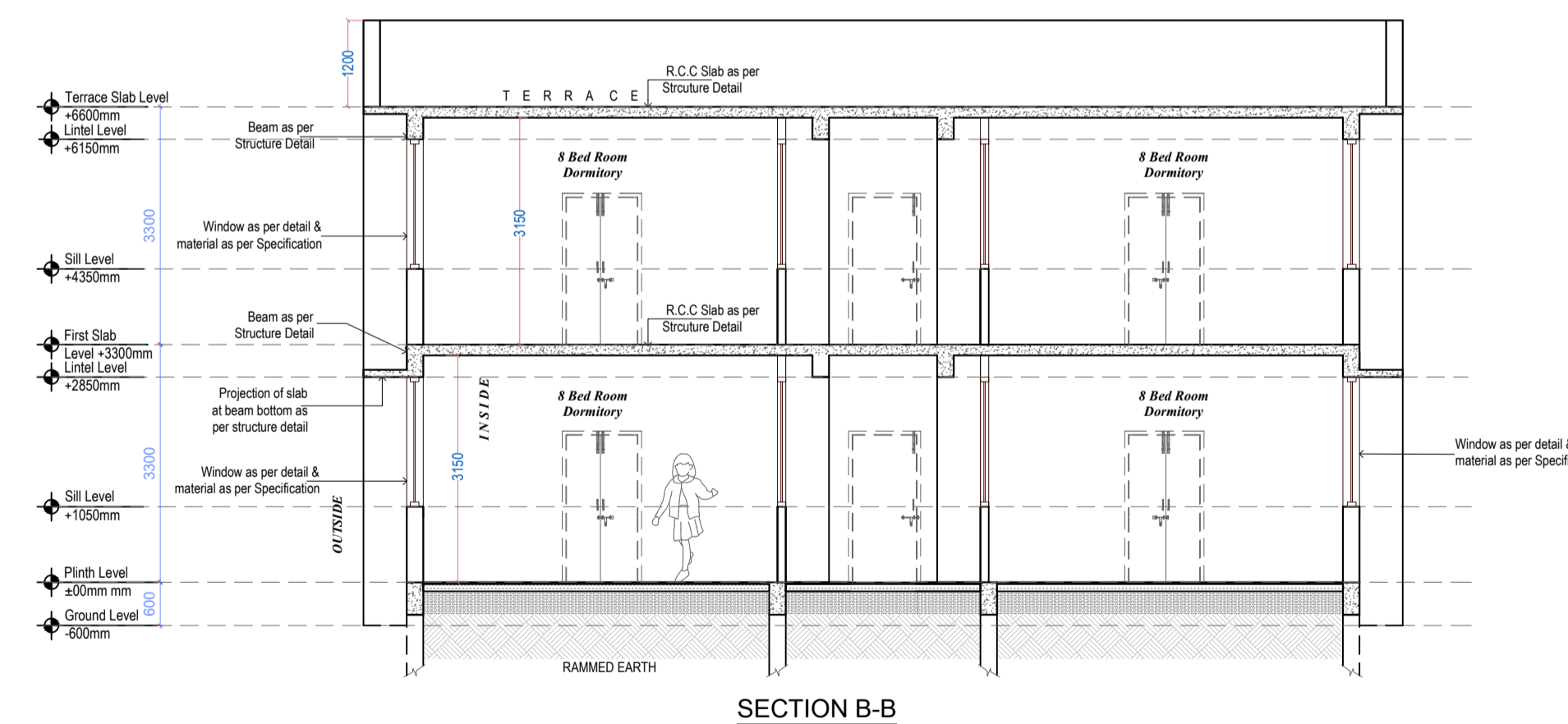

CATEGORY : GIRLS HOSTEL

DRAWING TITLE : ELEVATION & SECTION

DWG. NO.- EMRS NAME/GH/AR_04

DATE - 09 MARCH 2023

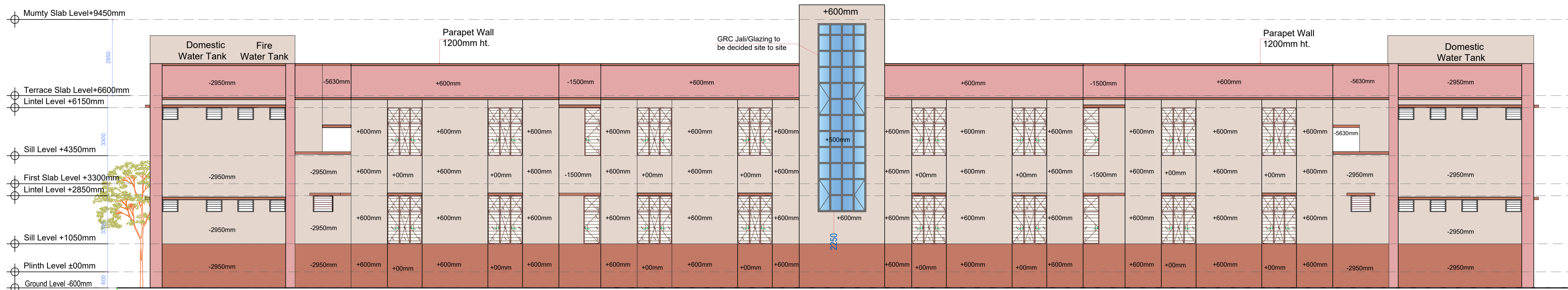

REAR ELEVATION E-05

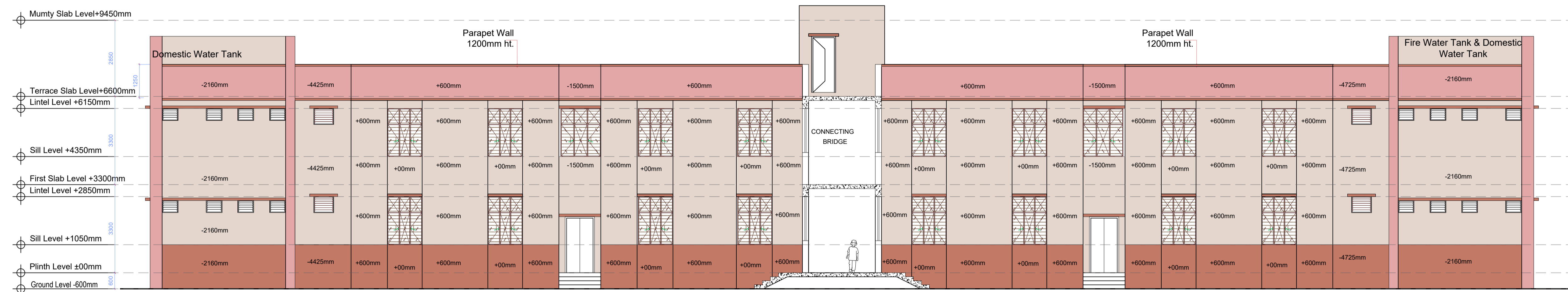

FRONT SIDE ELEVATION E-04

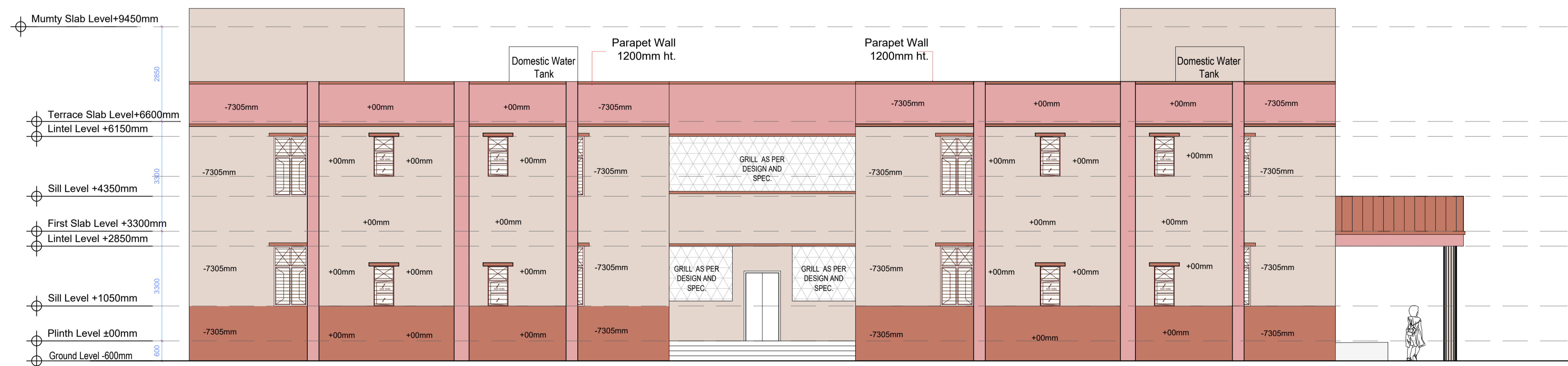

SIDE ELEVATION E-03

CATEGORY : GIRLS HOSTEL

DRAWING TITLE : ELEVATION

DWG. NO.- EMRS NAME/GH/AR_05

DATE - 09 MARCH 2023

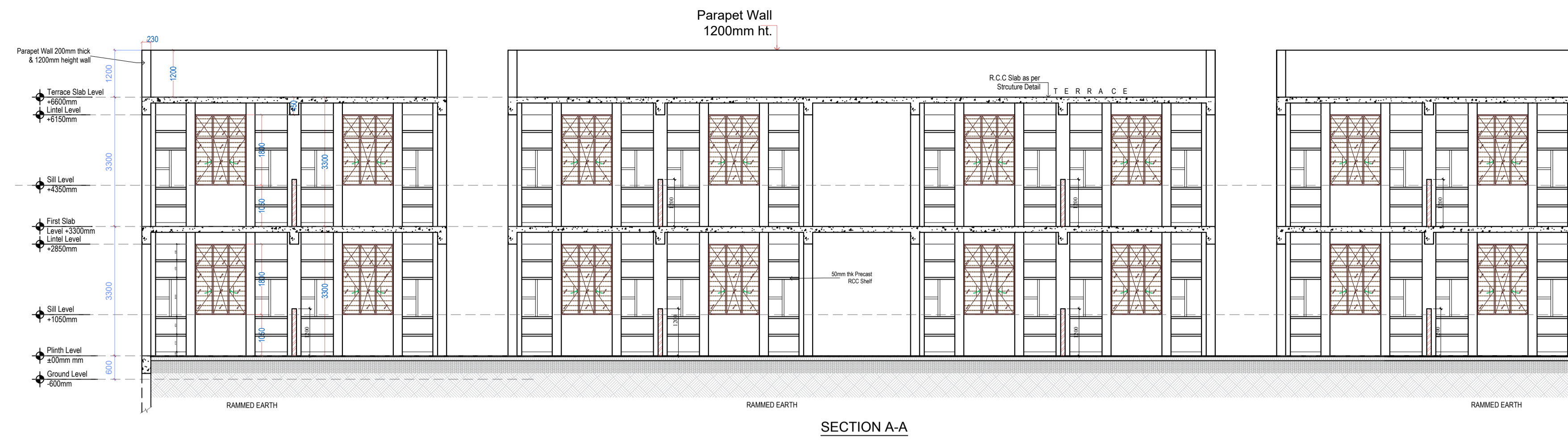

SECTION A-A

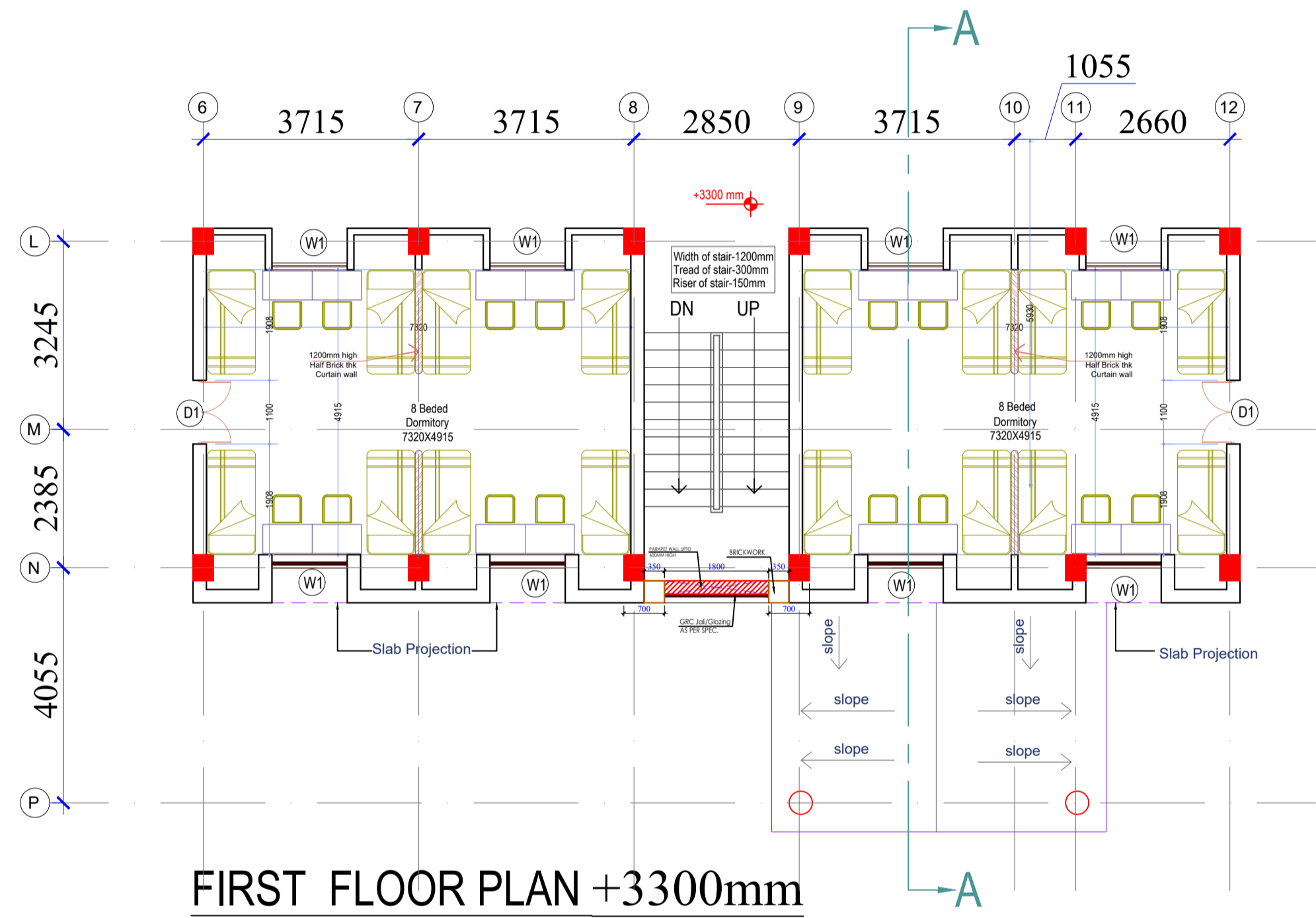

FIRST FLOOR PLAN +3300mm

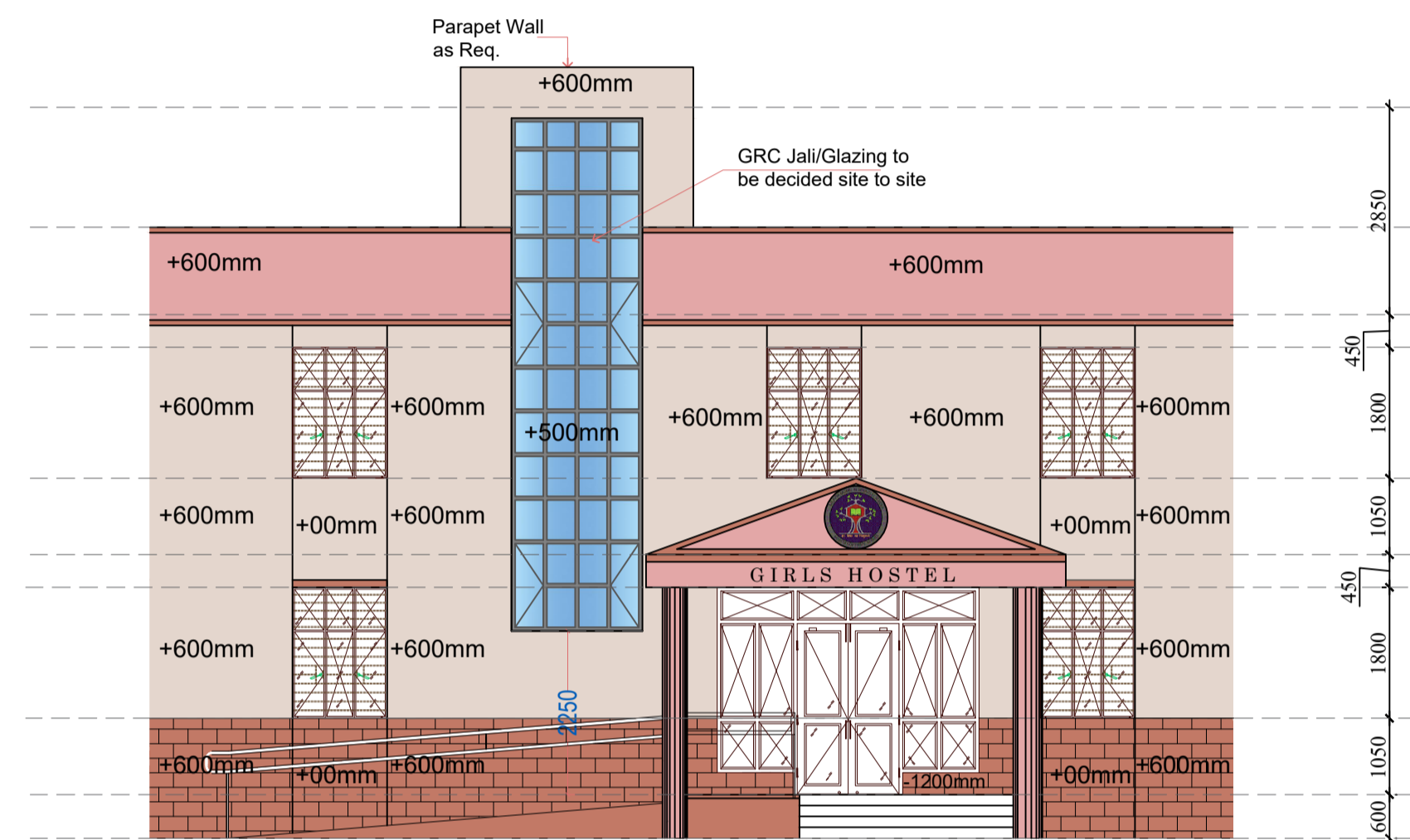
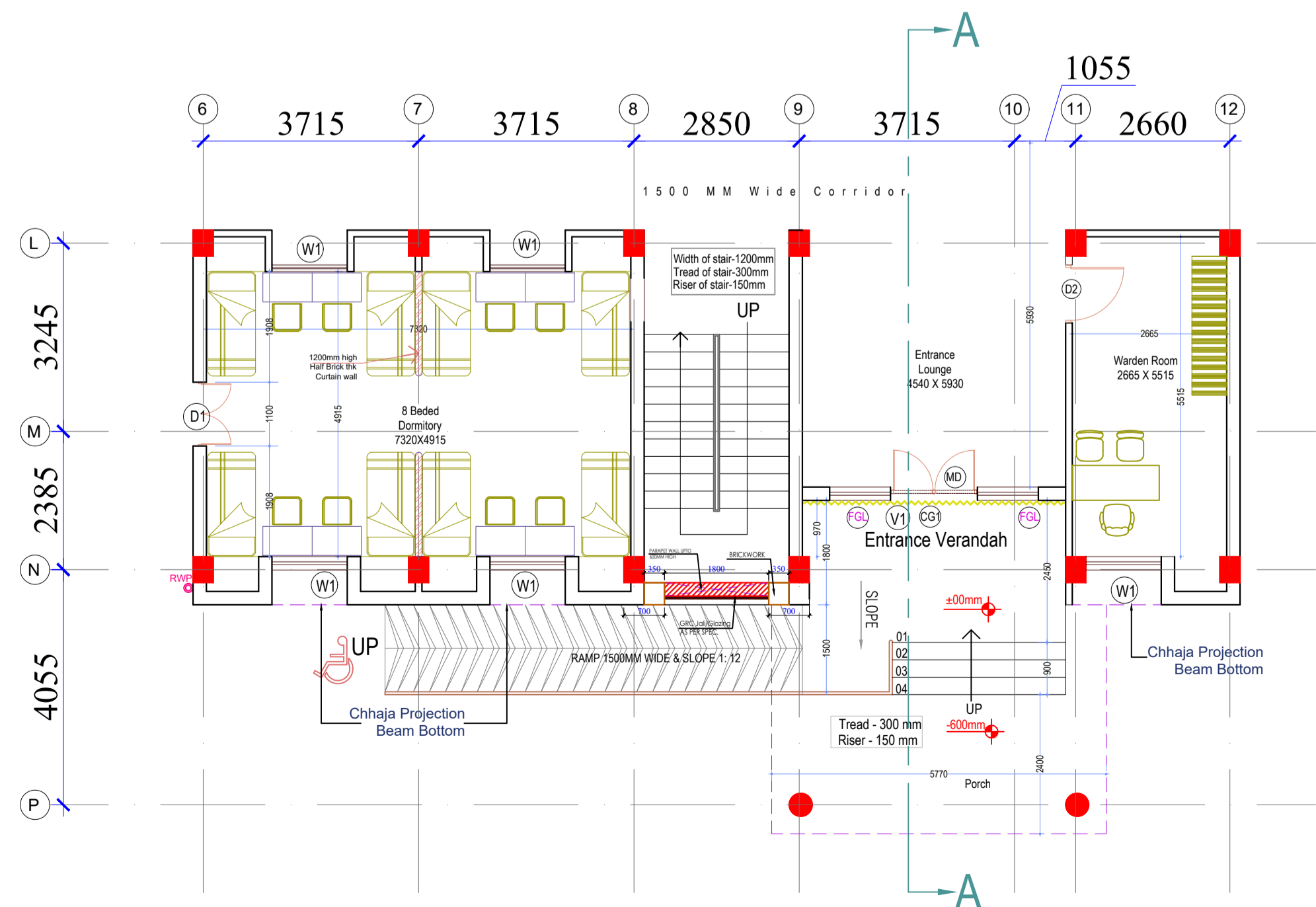

FRONT ELEVATION

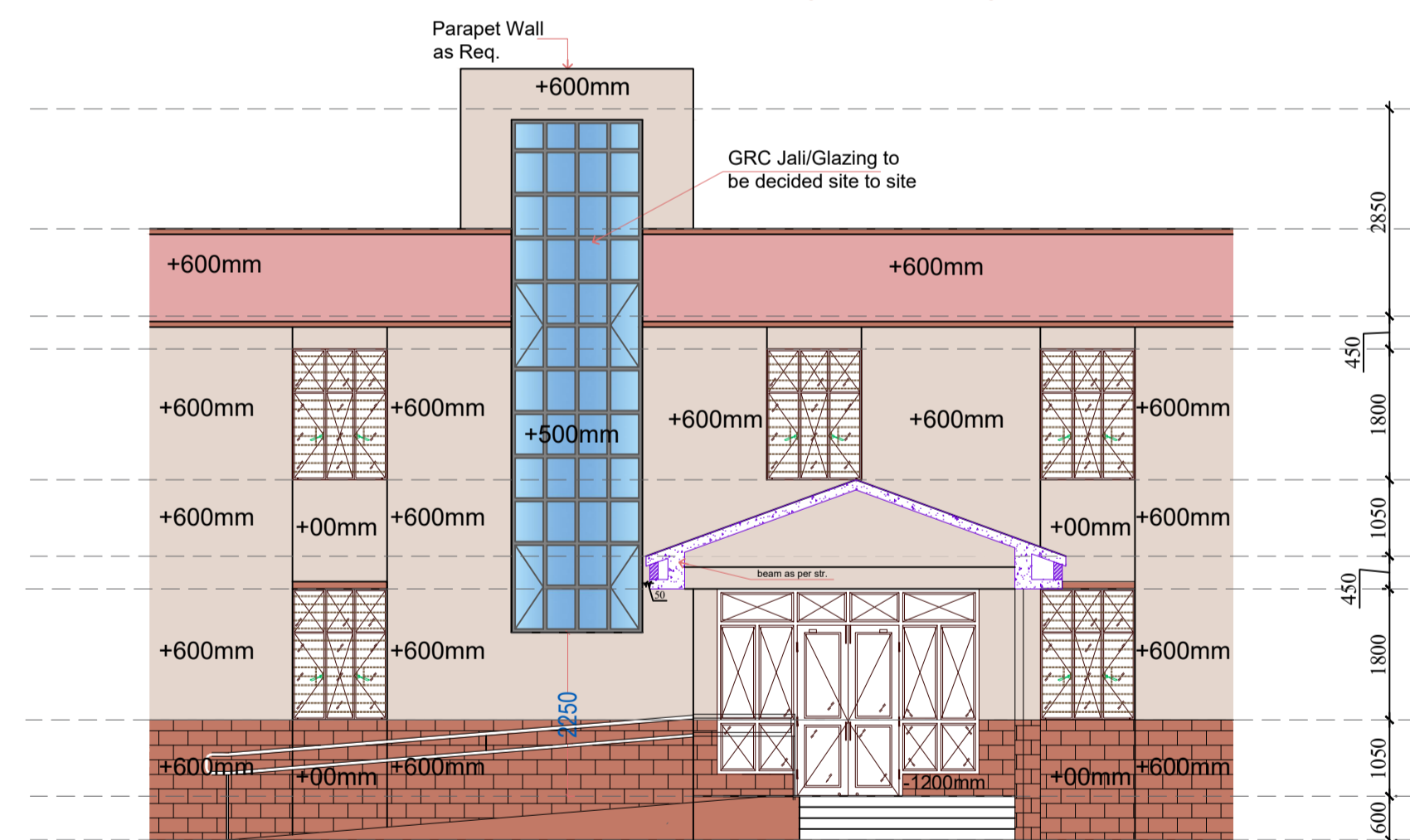

FRONT ELEVATION

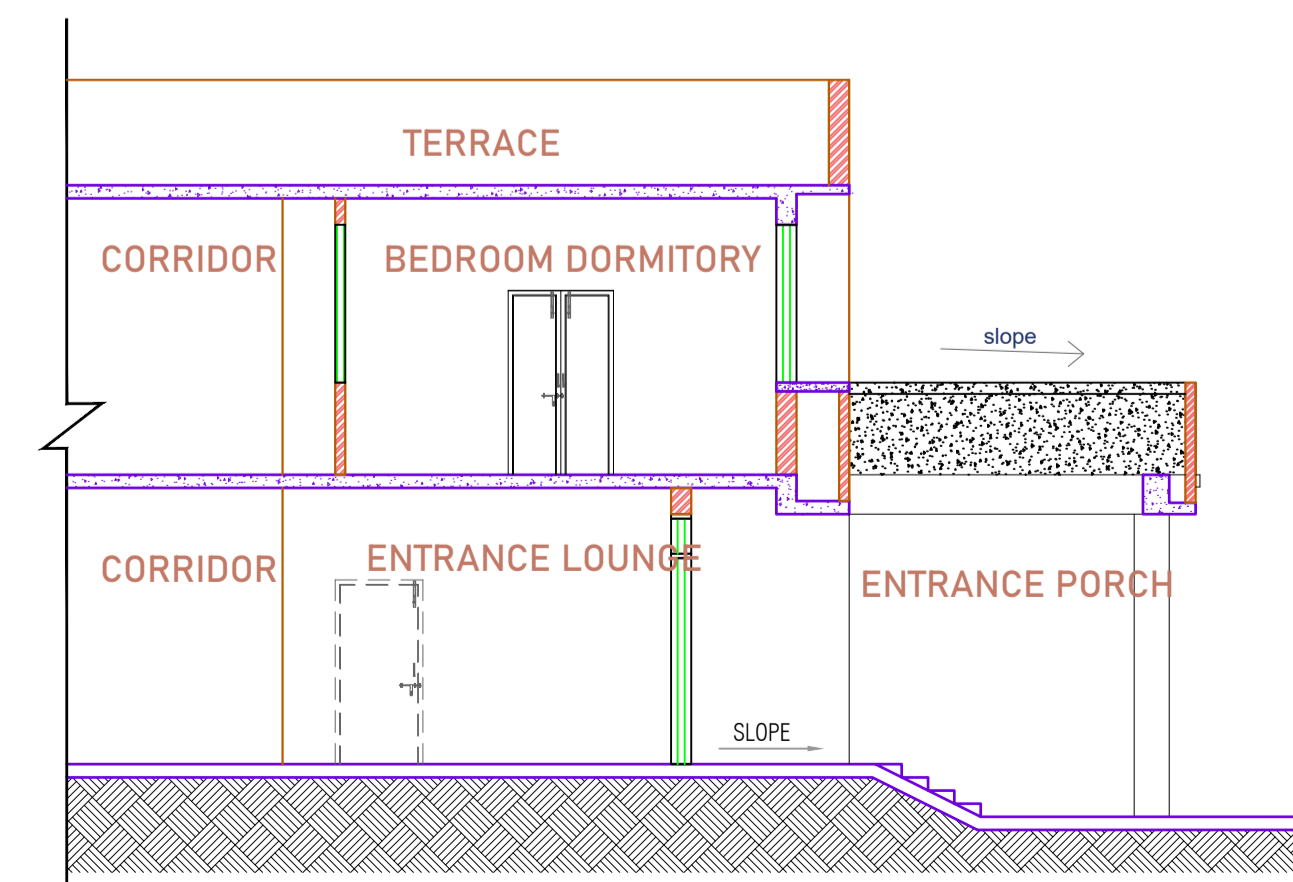

SECTIONAL VIEW A-A

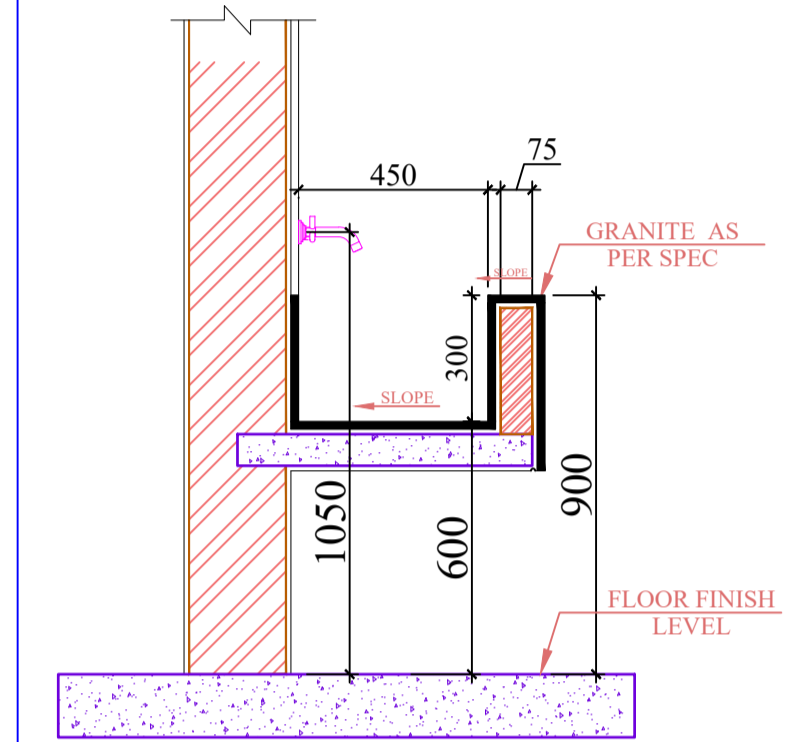

TROUGH TYPICAL SECTION

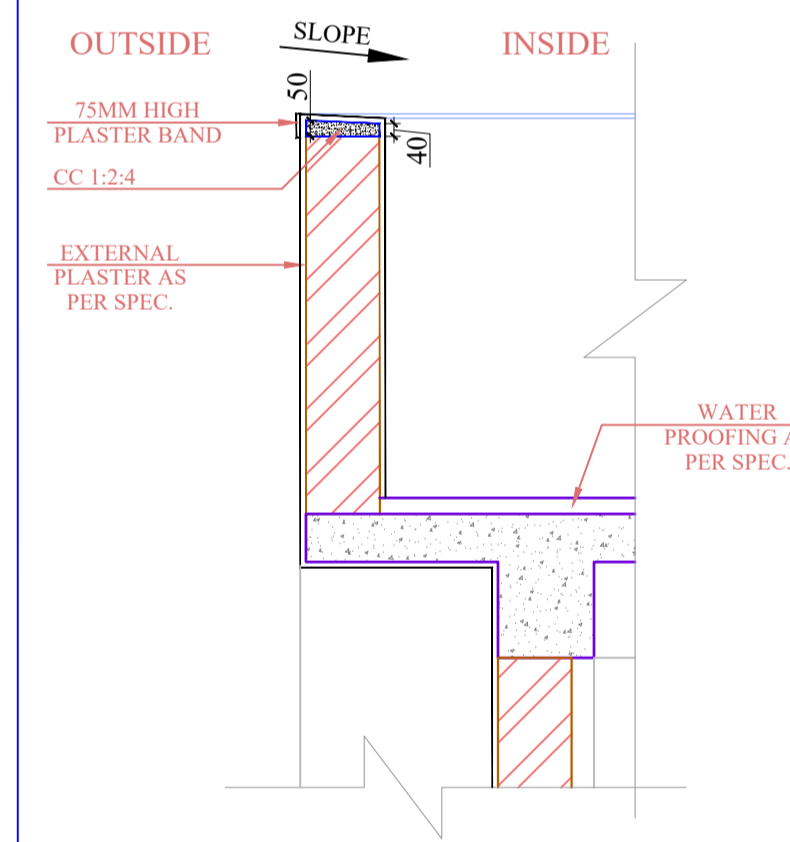

TERRACE PARAPET WALL TYPICAL COPING DETAIL

CATEGORY : GIRLS HOSTEL

DRAWING TITLE : SECTION & PORCH DETAIL

DWG. NO.-
EMRS NAME/GH/AR_06

DATE - 09 MARCH 2023



NOTES -

FRONT ENTRANCE RAMP SHALL BE AS PER SITE

EXHAUST FAN OPENINGS WITH 2NOs RAG BOLTS

Area - 550 Sq. Mt.

| KITCHEN AND DINING BLOCK CLEAR OPENING SCHEDULE | | | | | | | |
|---|--------------|------|--------|----|-------------------------------|--------------------------------|------------------|
| TAG | OPENING SIZE | SILL | LINTEL | GF | LOCATION | MATERIAL | COMMENTS |
| MD | 1800 X 2100 | 0 | 2100 | 2 | MAIN ENTRANCE | ALUMINIUM | DOUBLE SHUTTER |
| D1 | 1500 X 2100 | 0 | 2100 | 1 | PANTRY | FLUSH DOOR | DOUBLE SHUTTER |
| D2 | 1200 X 2100 | 0 | 2100 | 2 | FRONT UTENSILS WASH AREA | FACTORY PRESSED LAMINATED DOOR | DOUBLE SHUTTER |
| D2 | 1200 X 2100 | 0 | 2100 | 1 | REAR KITCHEN COURTYARD | GRILL DOOR | DOUBLE SHUTTER |
| D2 | 1200 X 2100 | 0 | 2100 | 4 | KITCHEN, DINING HALL | FLUSH DOOR | SINGLE SHUTTER |
| D3 | 1000 X 2100 | 0 | 2100 | 3 | STORE ROOM | FLUSH DOOR | SINGLE SHUTTER |
| D4 | 750 X 2100 | 0 | 2100 | 3 | WC DOOR | PRELAMINATED DOOR | SINGLE SHUTTER |
| D4 | 750 X 2100 | 0 | 2100 | 1 | GAS BANK | GRILL DOOR | SINGLE SHUTTER |
| CG1 | 3760 X 2100 | 0 | 2100 | 2 | MAIN ENTRANCE | | COLLAPSIBLE GATE |
| W1 | 1500 X 1800 | 750 | 2550 | 6 | DINING HALL | STEEL GLAZED WINDOW | |
| W2 | 1000 X 1800 | 750 | 2550 | 16 | ENTRANCE LOBBY, PANTRY, STORE | STEEL GLAZED WINDOW | |
| W3 | 1800 X 1650 | 900 | 2550 | 2 | KITCHEN | STEEL GLAZED WINDOW | |
| GL1 | 750 X 2250 | 300 | 2550 | 4 | MAIN ENTRANCE | ALUMINIUM | FIXED GLAZING |
| V1 | 600 X 900 | 1650 | 2550 | 6 | TOILET | STEEL SECTION | |
| V2 | 1800 X 450 | 2100 | 2550 | 2 | MAIN ENTRANCE | ALUMINIUM | |
| V3 | 1000 X 900 | 2100 | BOB | 6 | KITCHEN | STEEL SECTION | FIXED GLAZING |

CATEGORY : KITCHEN & DINING BLOCK

DRAWING TITLE : GROUND FLOOR PLAN

DWG. NO.- EMRS NAME/K&D/AR_01

DATE - 09 MARCH 2023

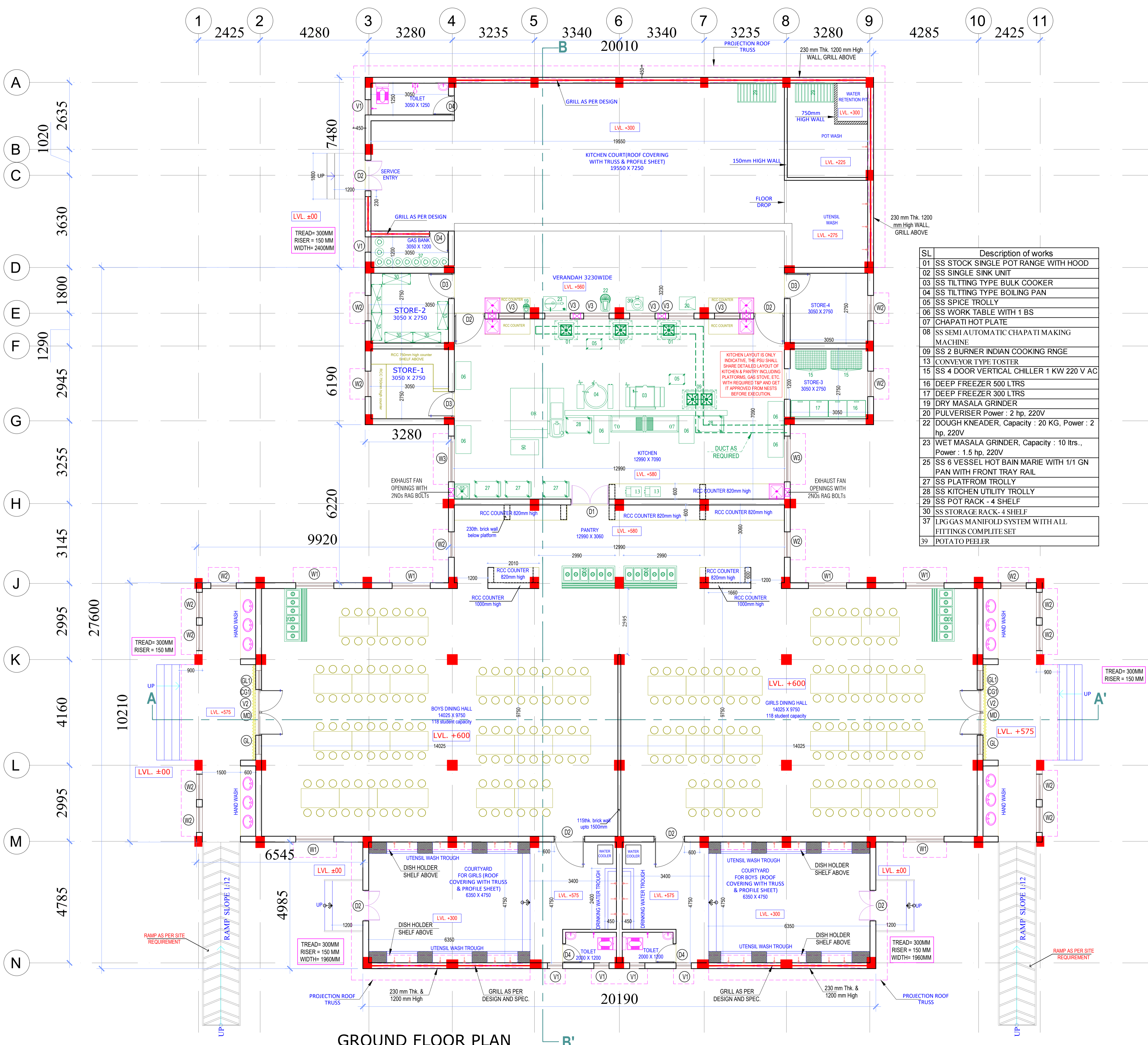

| SL | Description of works |
|----|---|
| 01 | SS STOCK SINGLE POT RANGE WITH HOOD |
| 02 | SS SINGLE SINK UNIT |
| 03 | SS TILTING TYPE BULK COOKER |
| 04 | SS TILTING TYPE BOILING PAN |
| 05 | SS SPICE TROLLEY |
| 06 | SS WORK TABLE WITH 1 BS |
| 07 | CHAPATI HOT PLATE |
| 08 | SS SEMI AUTOMATIC CHAPATI MAKING MACHINE |
| 09 | SS 2 BURNER INDIAN COOKING RNGE |
| 13 | CONVEYOR TYPE TOSTER |
| 15 | SS 4 DOOR VERTICAL CHILLER 1 KW 220 V AC |
| 16 | DEEP FREEZER 500 LTRS |
| 17 | DEEP FREEZER 300 LTRS |
| 19 | DRY MASALA GRINDER |
| 20 | PULVERISER Power : 2 hp, 220V |
| 22 | DOUGH KNEADER, Capacity : 20 KG, Power : 2 hp, 220V |
| 23 | WET MASALA GRINDER, Capacity : 10 ltrs., Power : 1.5 hp, 220V |
| 25 | SS 6 VESSEL HOT BAIN MARIE WITH 1/1 GN PAN WITH FRONT TRAY RAIL |
| 27 | SS PLATFORM TROLLEY |
| 28 | SS KITCHEN UTILITY TROLLEY |
| 29 | SS POT RACK - 4 SHELF |
| 30 | SS STORAGE RACK - 4 SHELF |
| 37 | LPG GAS MANIFOLD SYSTEM WITH ALL FITTINGS COMPLETE SET |
| 39 | POTATO PEELER |

GROUND FLOOR PLAN

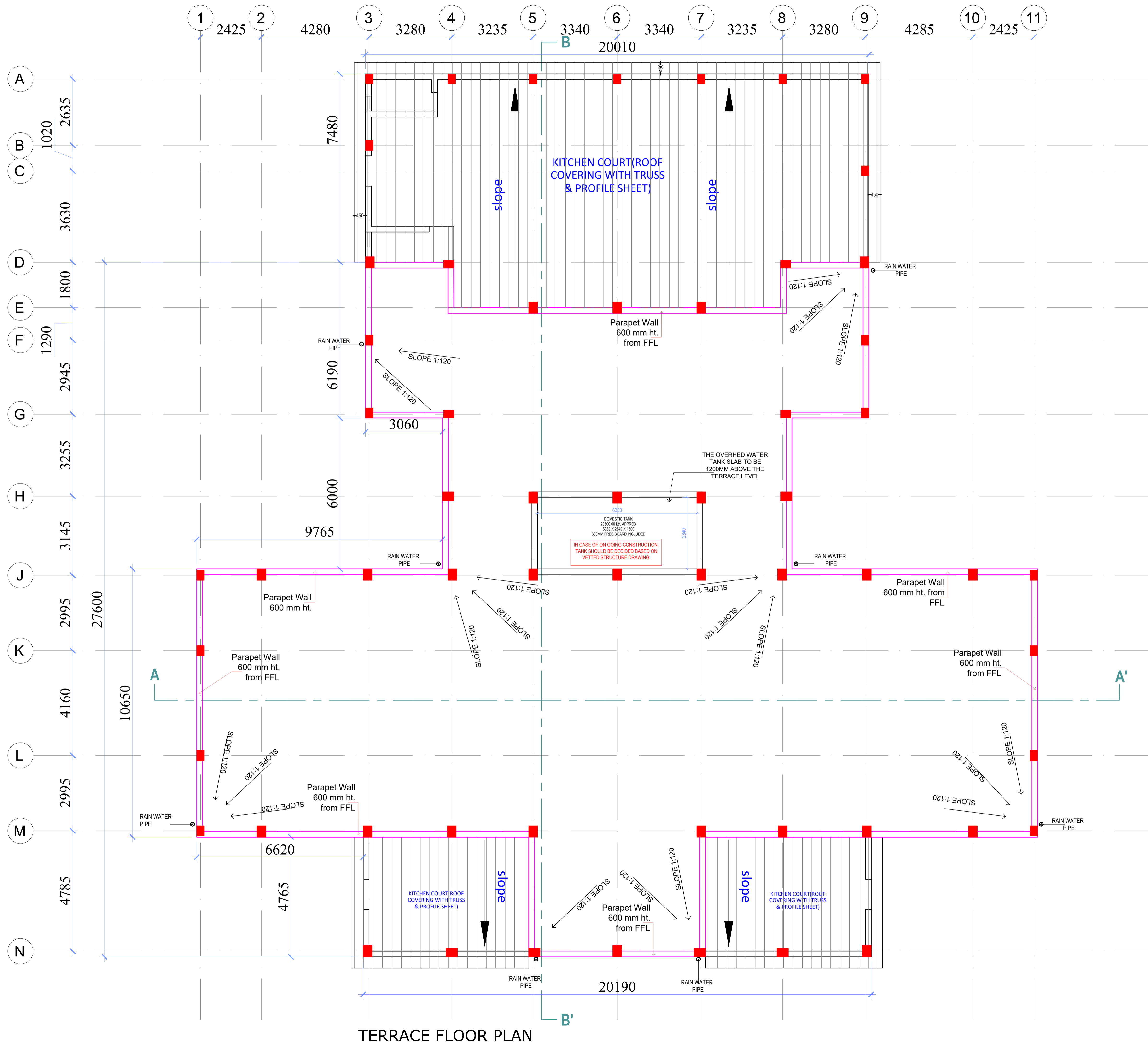

TERRACE FLOOR PLAN

CATEGORY : KITCHEN & DINING BLOCK

DRAWING TITLE : TERRACE FLOOR PLAN

DWG. NO.-
EMRS NAME/K&D/AR_02

DATE - 09 MARCH 2023

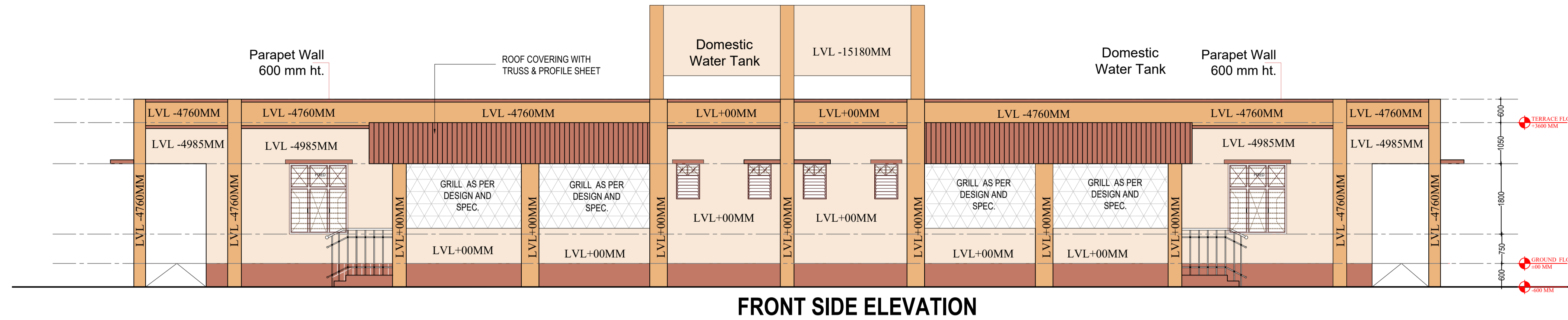

FRONT SIDE ELEVATION

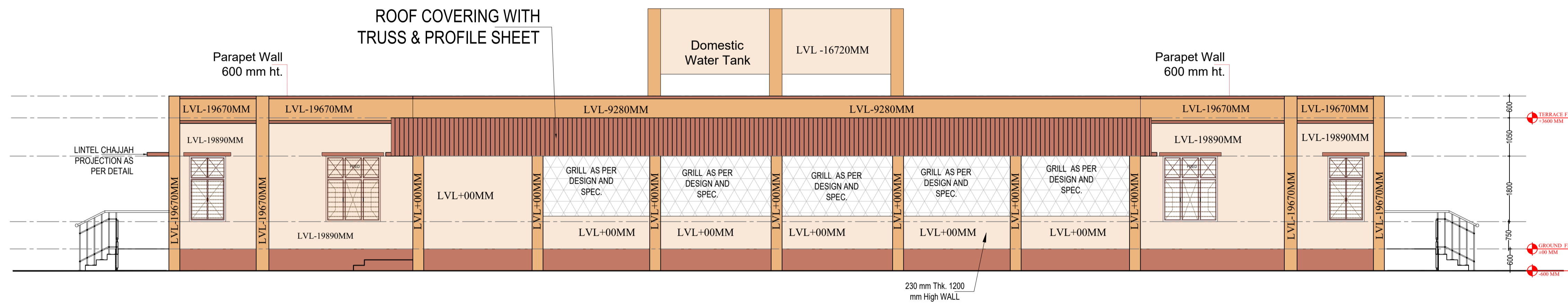

REAR SIDE ELEVATION

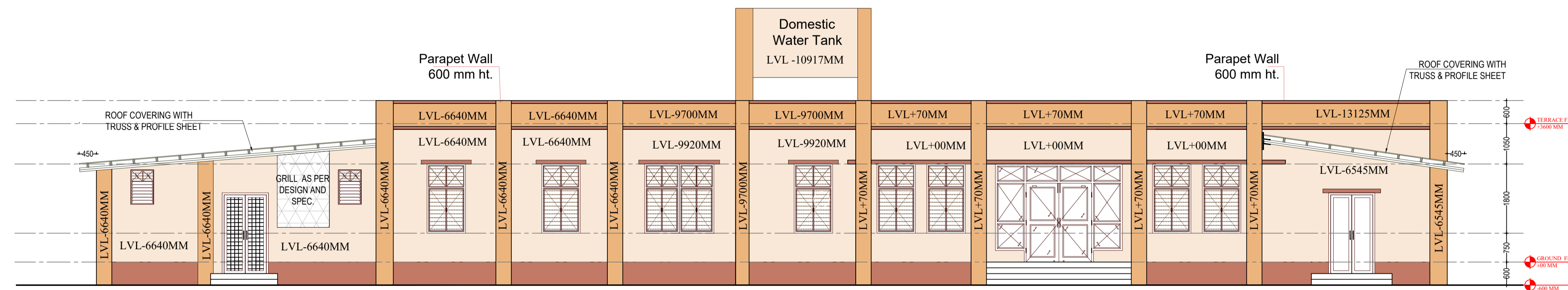

GIRLS ENTRY SIDE ELEVATION

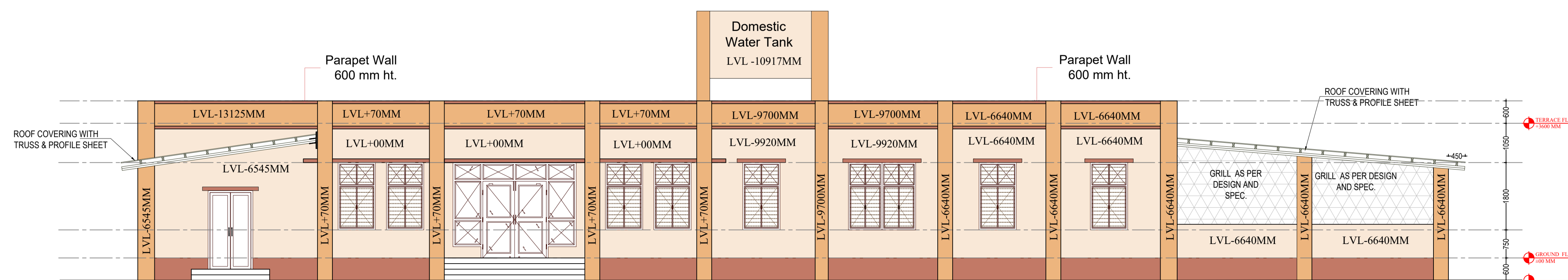

BOYS ENTRY SIDE ELEVATION

CATEGORY : KITCHEN & DINING BLOCK

DRAWING TITLE : ELEVATION AA/BB/CC/DD

DWG. NO.-
EMRS NAME/K&D/AR_03

DATE - 09 MARCH 2023

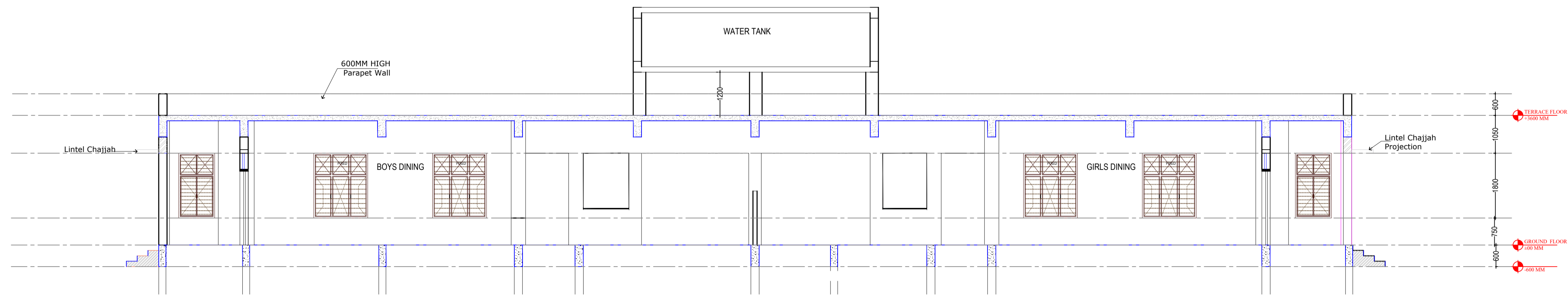

SECTION - AA

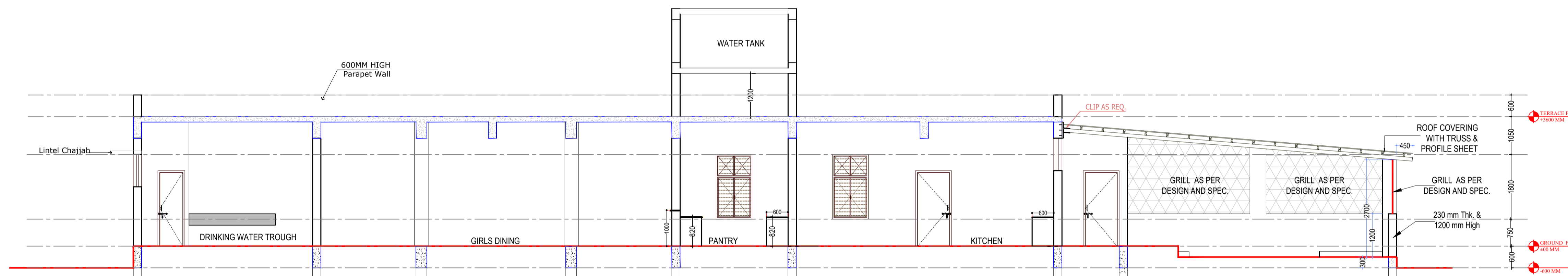

SECTION - BB

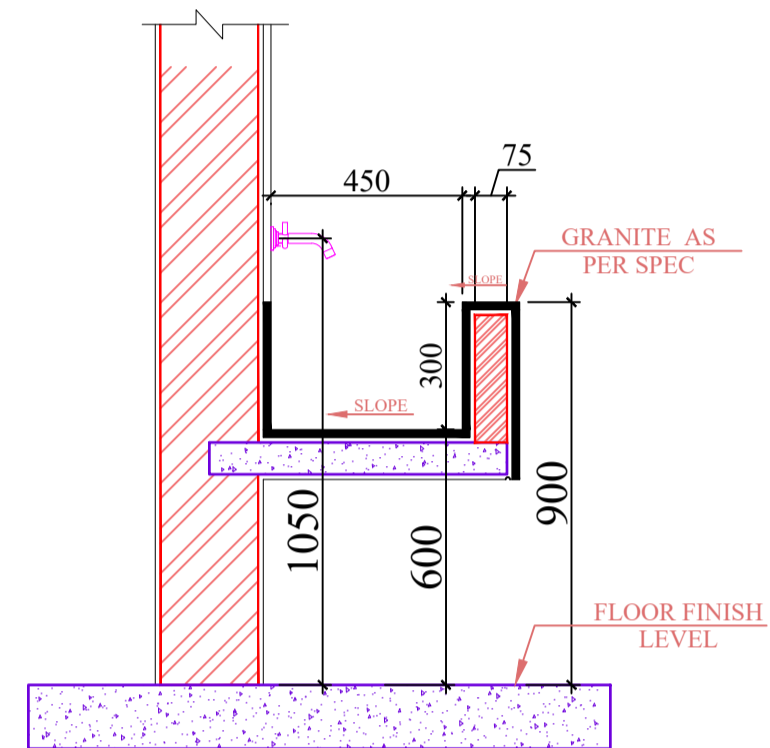

TROUGH TYPICAL SECTION

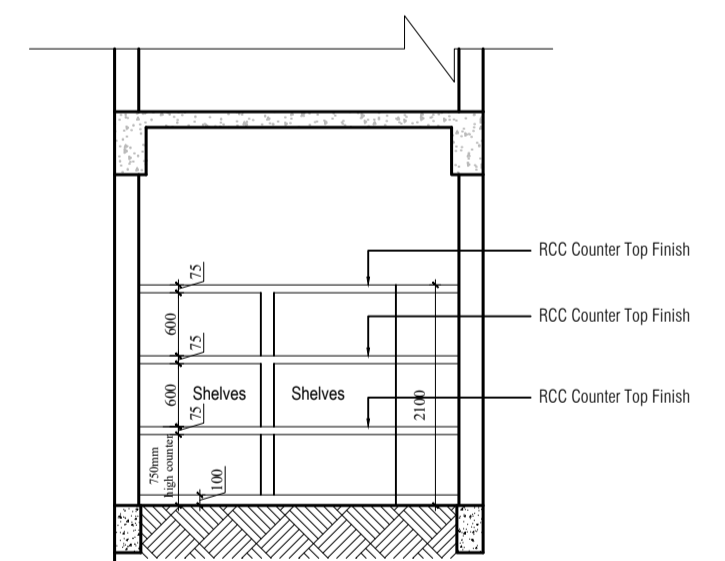

Store RCC 850mm high counter SHELF ABOVE

CATEGORY : KITCHEN & DINING BLOCK

DRAWING TITLE : SECTION AA/BB

DWG. NO.- EMRS NAME/K&D/AR_04

DATE - 09 MARCH 2023

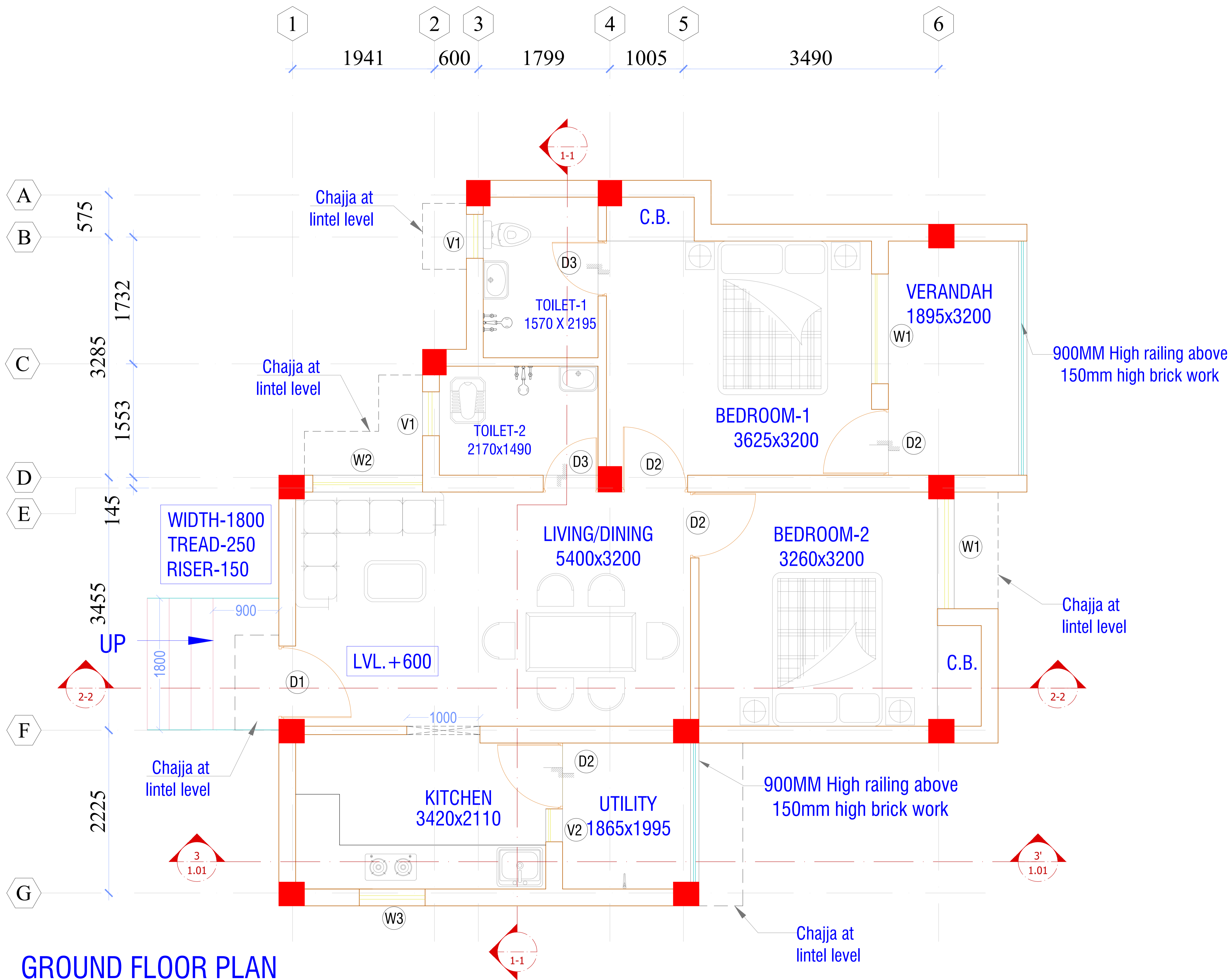

GROUND FLOOR PLAN

PROJECT - EMRS
 CONSTRUCTION OF SCHOOL BUILDING
 FOR EKLAVYA MODEL RESIDENTIAL
 SCHOOL (EMRS)
 CLIENT -
GOVERNMENT OF INDIA
MINISTRY OF TRIBAL AFFAIRS
NATIONAL EDUCATION
SOCIETY FOR TRIBAL STUDENTS



| WARDEN RESIDENCE | | | | | | | |
|--|--------------------|------|--------|----|---------------------------|--------------------------------|-------------|
| DOOR, WINDOW, VENTILATOR, FIXED GLAZING, GRILL | SCHEDULE | | | | | | |
| TAG | CLEAR OPENING SIZE | SILL | LINTEL | GF | LOCATION | MATERIAL | COMMENTS |
| D1 | 1000 X 2100 | 0 | 2100 | 1 | MAIN ENTRANCE | FLUSH DOOR | SINGLE LEAF |
| D2 | 900 X 2100 | 0 | 2100 | 4 | BEDROOM, BALCONY, UTILITY | FLUSH DOOR | SINGLE LEAF |
| D3 | 750 X 2100 | 0 | 2100 | 2 | TOILET | FACTORY PRESSED LAMINATED DOOR | SINGLE LEAF |
| W1 | 1500 X 1350 | 750 | 2100 | 2 | BEDROOM | STEEL GLAZED WINDOW | |
| W2 | 1500 X 1200 | 900 | 2100 | 1 | LIVING ROOM | STEEL GLAZED WINDOW | |
| W3 | 900 X 1050 | 1050 | 2100 | 1 | KITCHEN | STEEL GLAZED WINDOW | |
| V1 | 600 X 750 | 1350 | 2100 | 2 | TOILET | STANDARD STEEL SECTION | |
| V2 | 450 X 1050 | 1050 | 2100 | 1 | KITCHEN | STEEL GLAZED WINDOW | |

UNIT AREA - 77.25 Sq. Mt.

CATEGORY : WARDEN RESIDENCE

DRAWING TITLE : GROUND FLOOR PLAN

DWG. NO.- EMRS NAME/WR/AR_01

DATE - 09 MARCH 2023

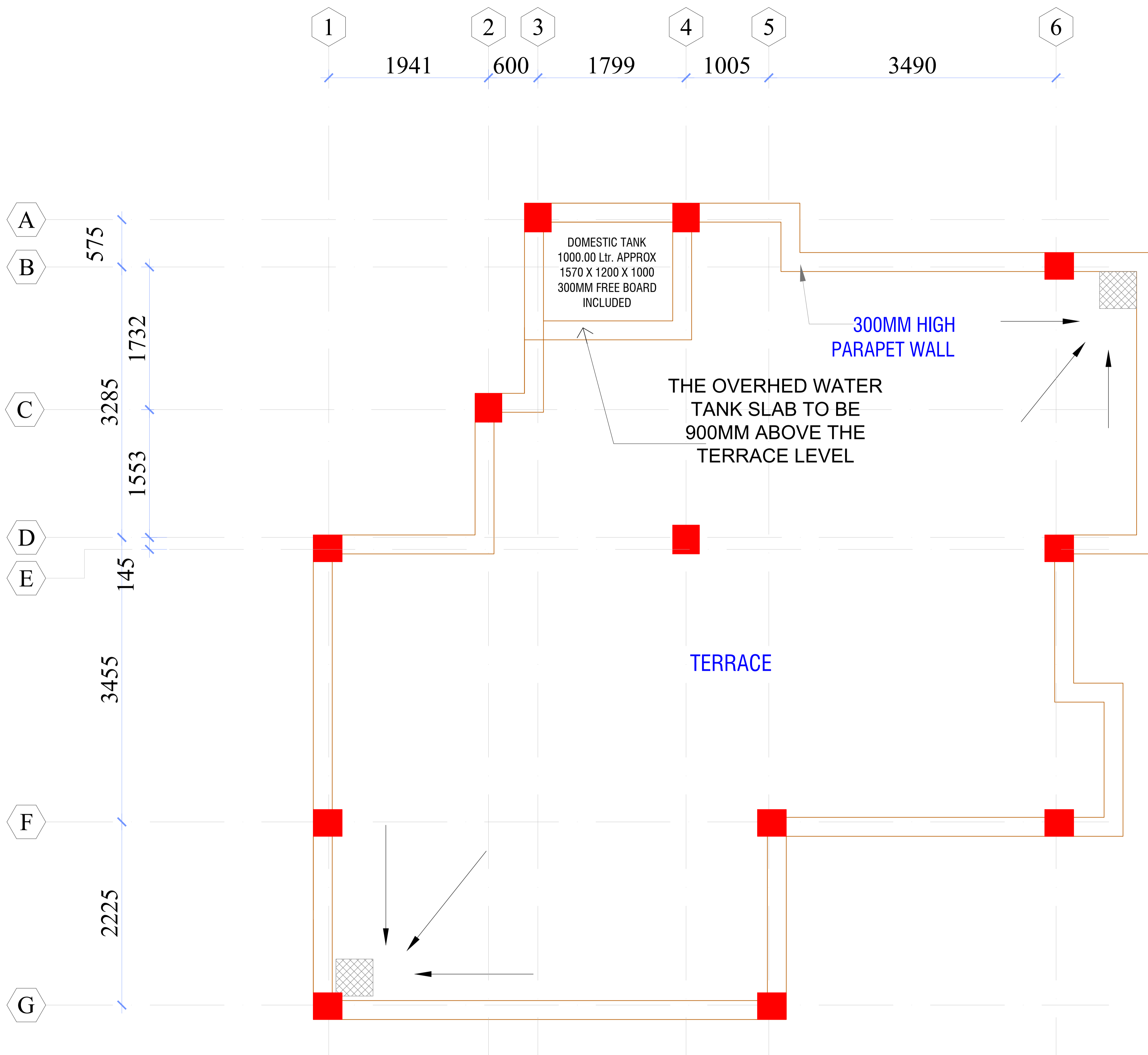

TERRACE FLOOR PLAN

CATEGORY : WARDEN RESIDENCE

DRAWING TITLE : TERRACE FLOOR PLAN

DWG. NO.-
EMRS NAME/WR/AR_02

DATE - 09 MARCH 2023

**GOVERNMENT OF INDIA
MINISTRY OF TRIBAL AFFAIRS
NATIONAL EDUCATION
SOCIETY FOR TRIBAL STUDENTS**

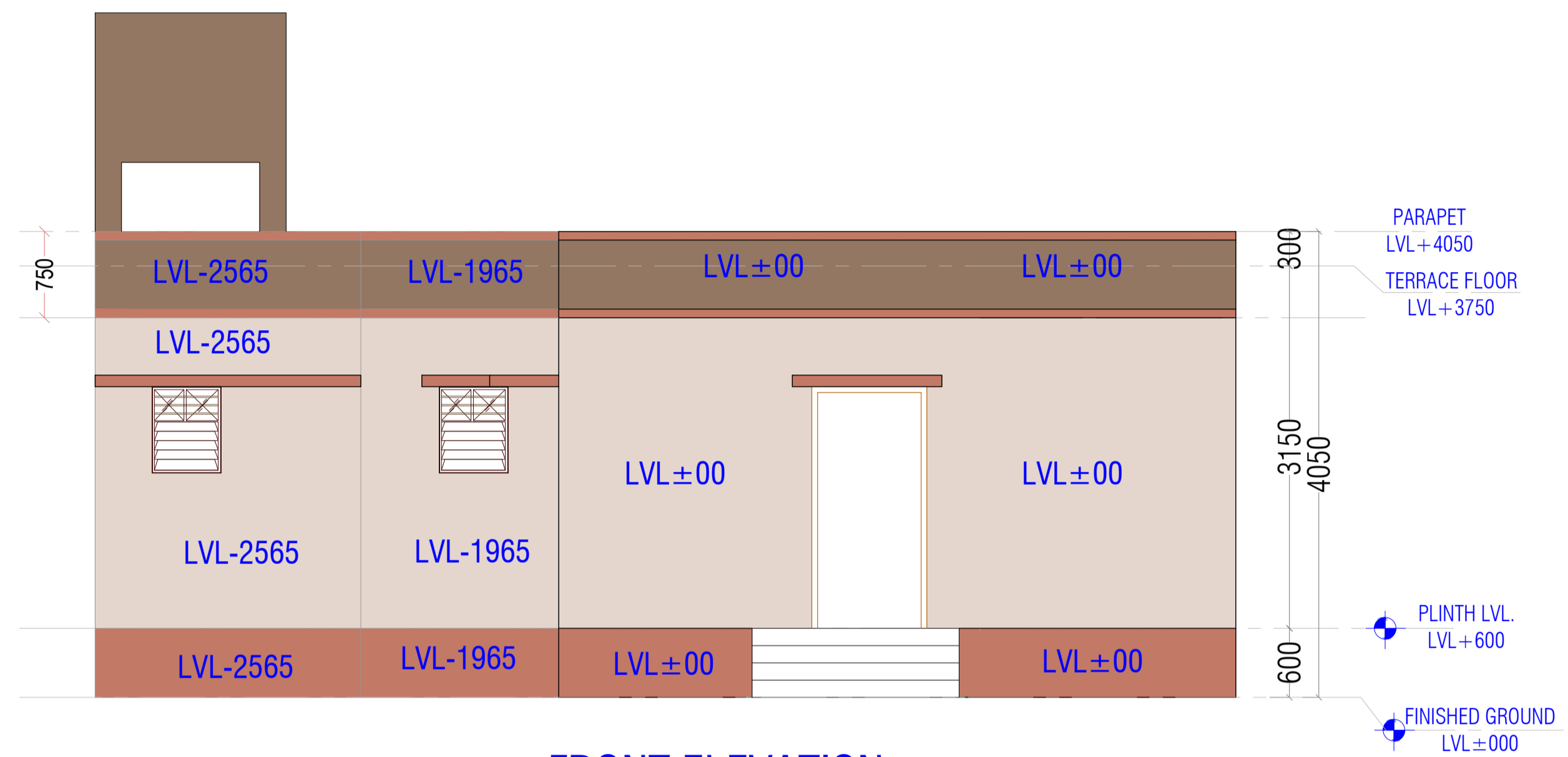

FRONT ELEVATION

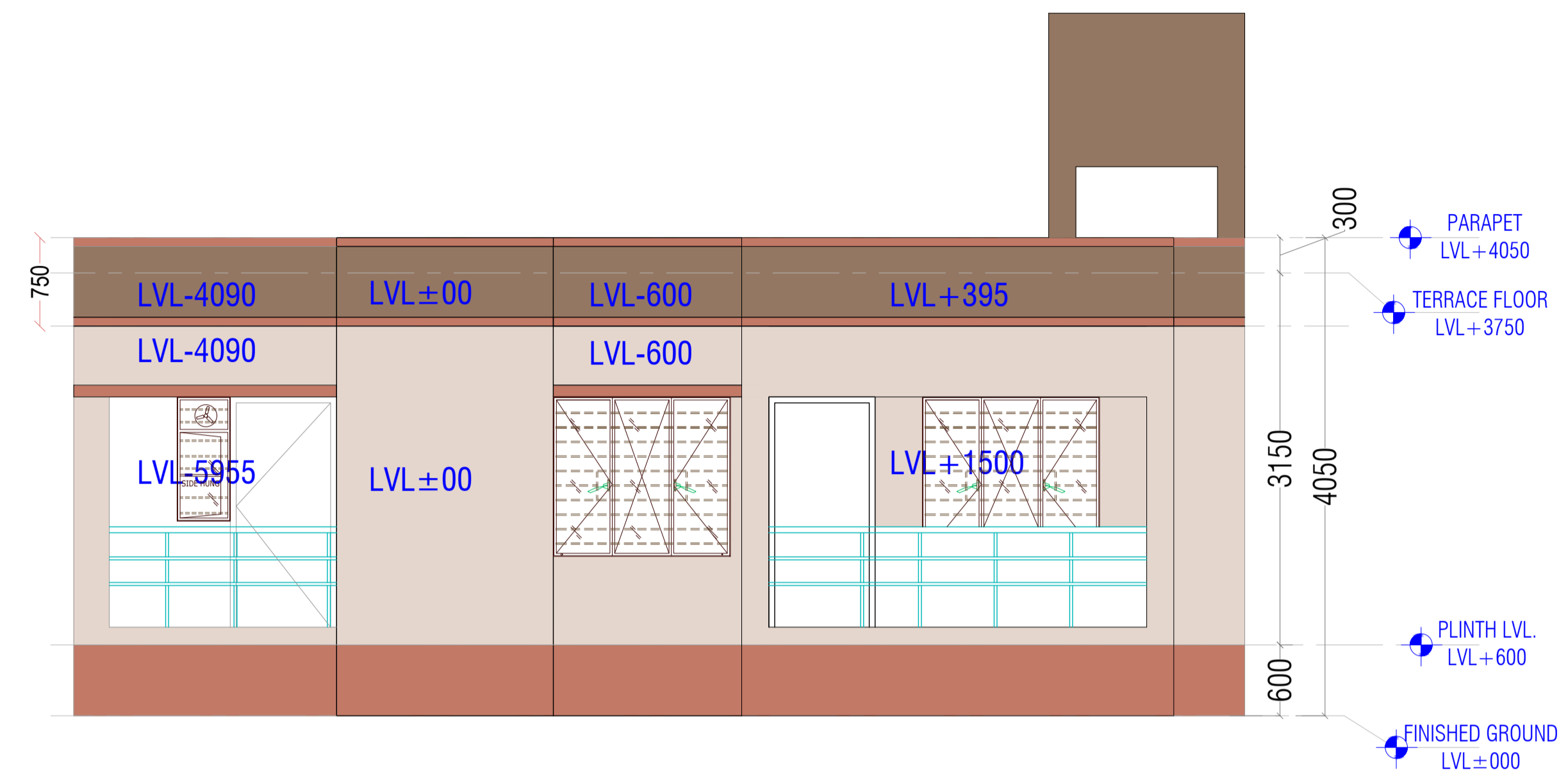

BACKSIDE ELEVATION

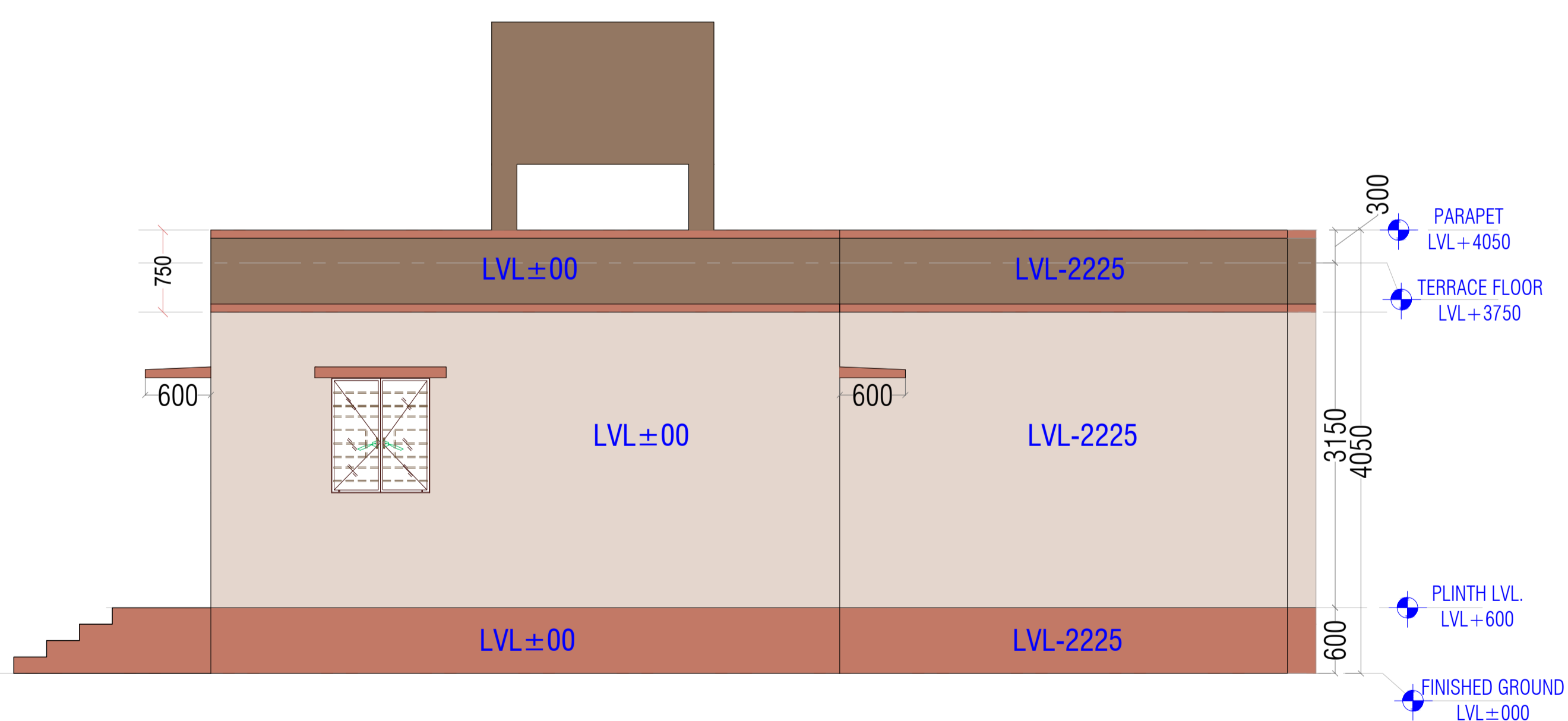

KITCHEN AND UTILITY SIDE ELEVATION

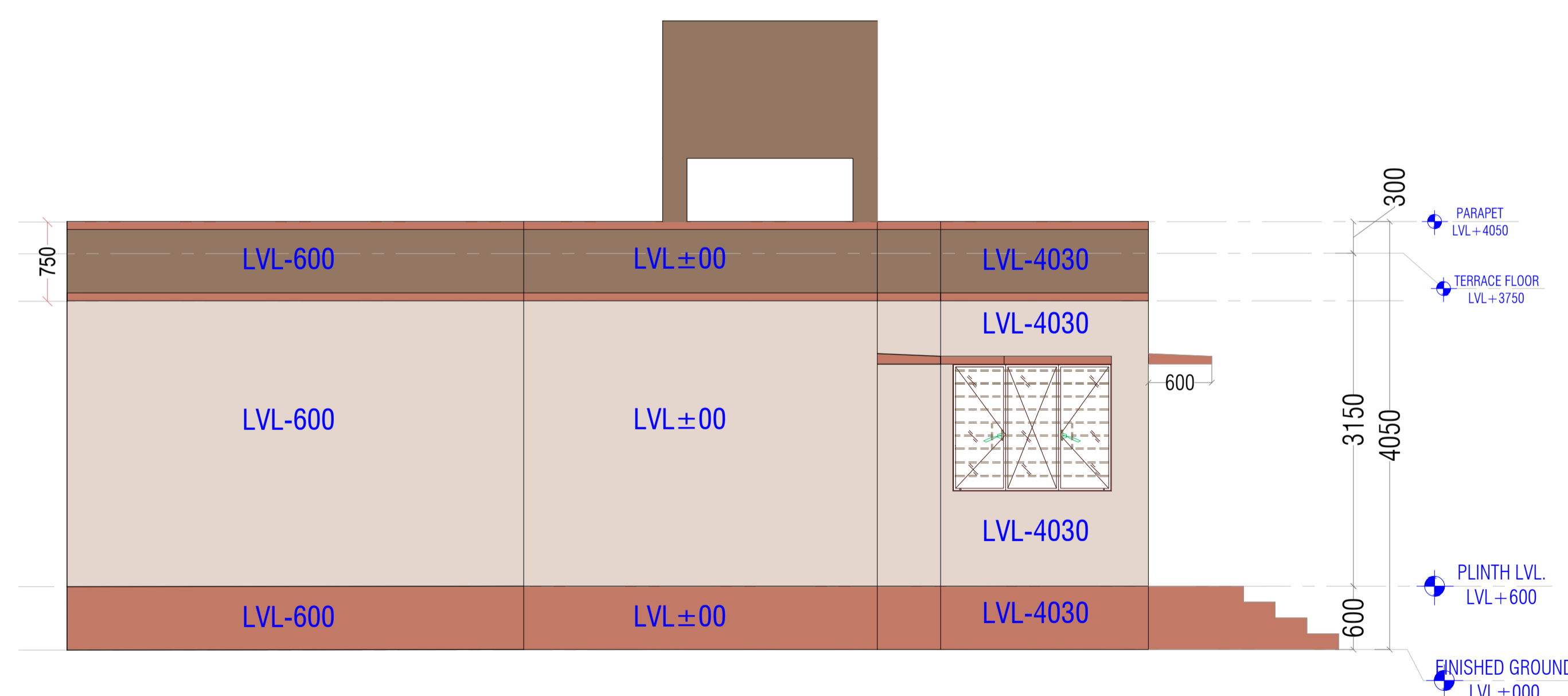

BEDROOM SIDE ELEVATION

CATEGORY : BOYS WARDEN RESIDENCE

DRAWING TITLE : ELEVATIONS

DWG. NO.-
EMRS NAME/BWR/AR_03

DATE - 09 MARCH 2023

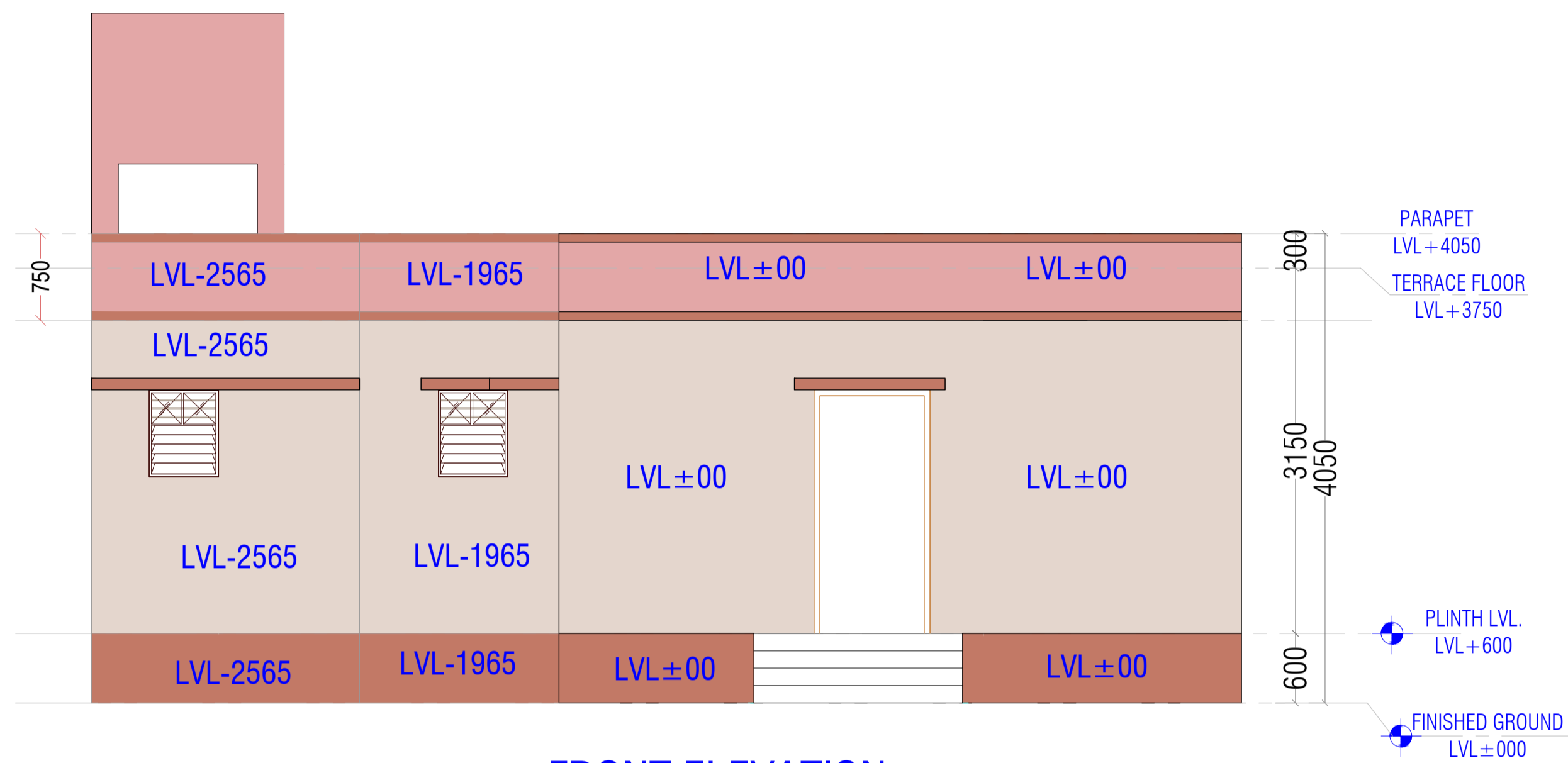

FRONT ELEVATION

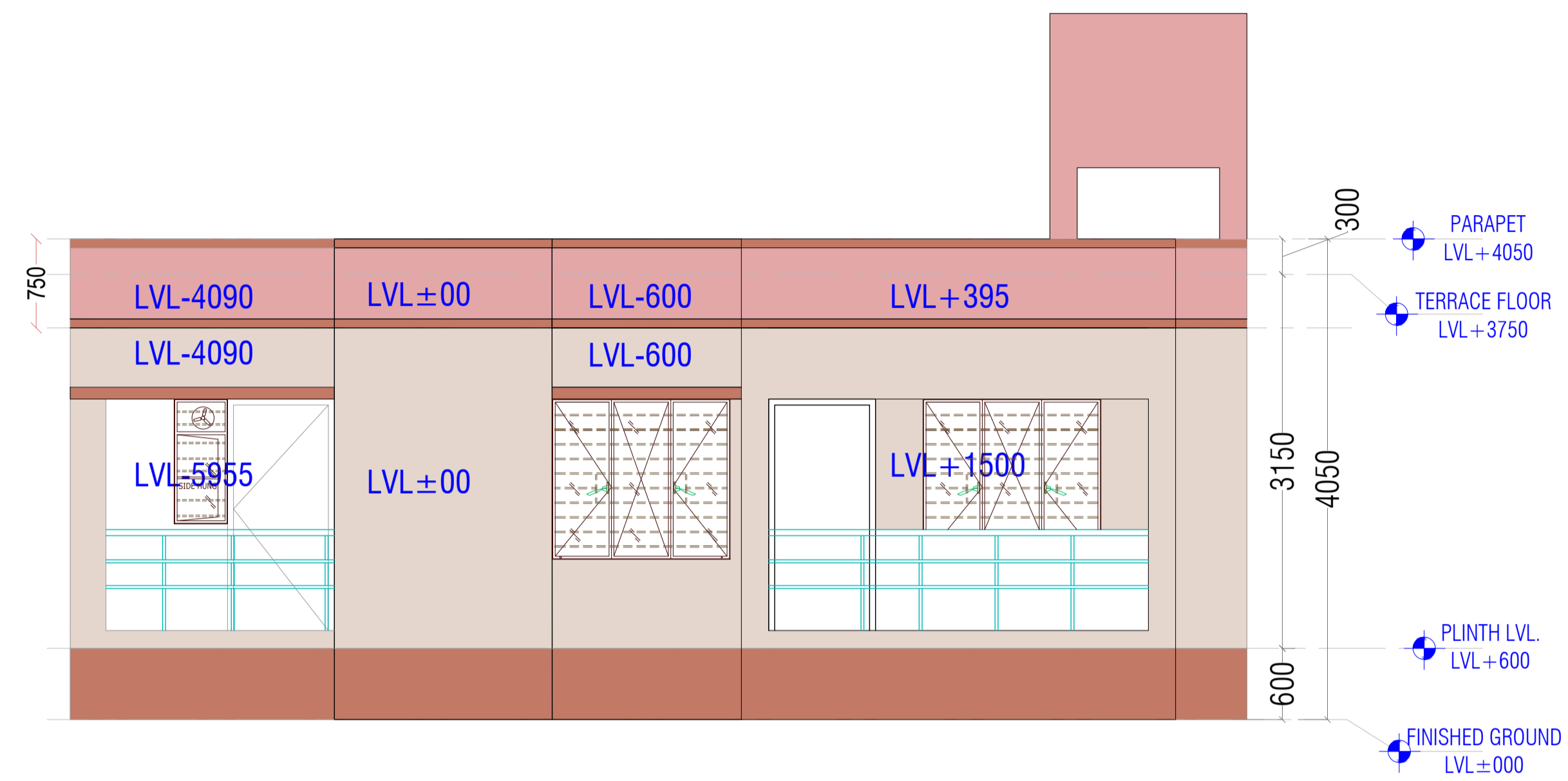

BACKSIDE ELEVATION

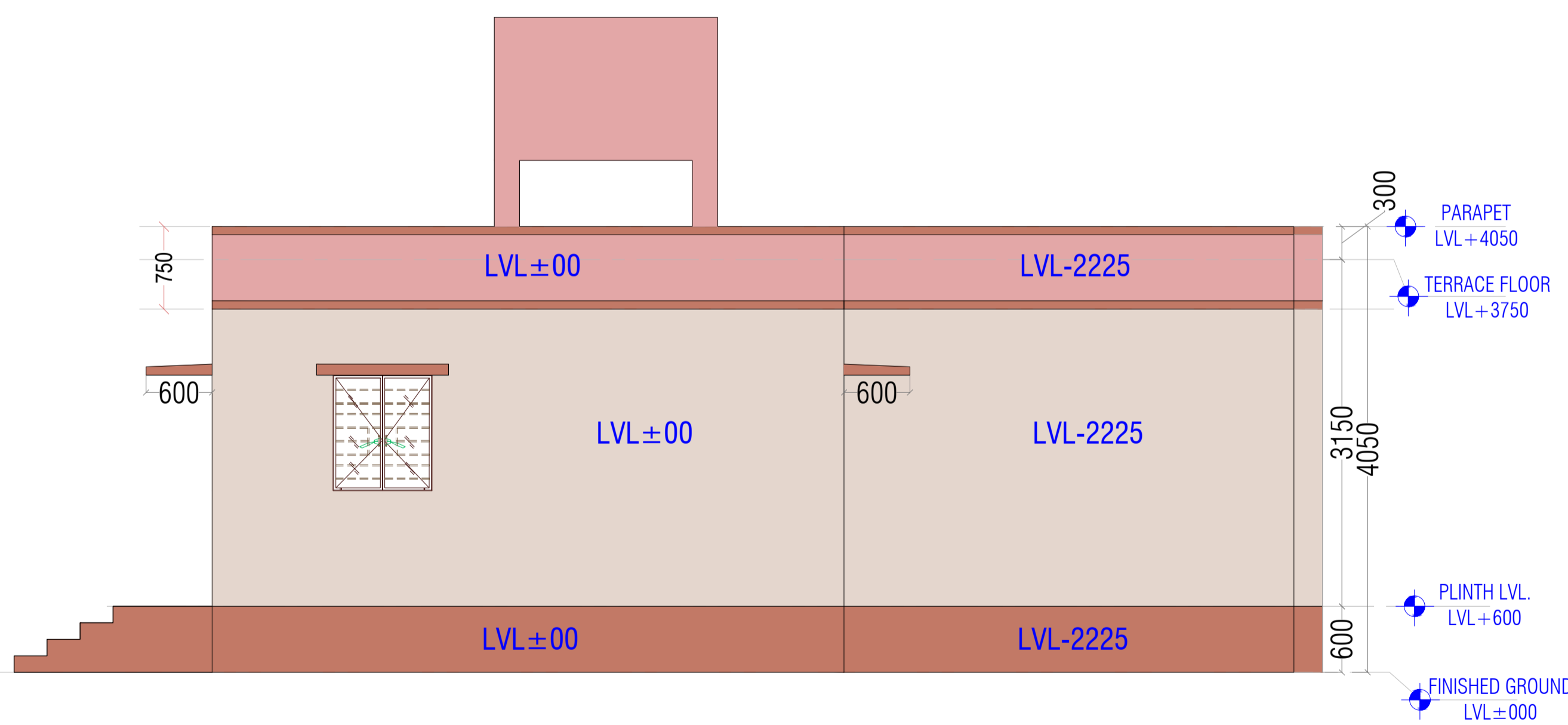

KITCHEN AND UTILITY SIDE ELEVATION

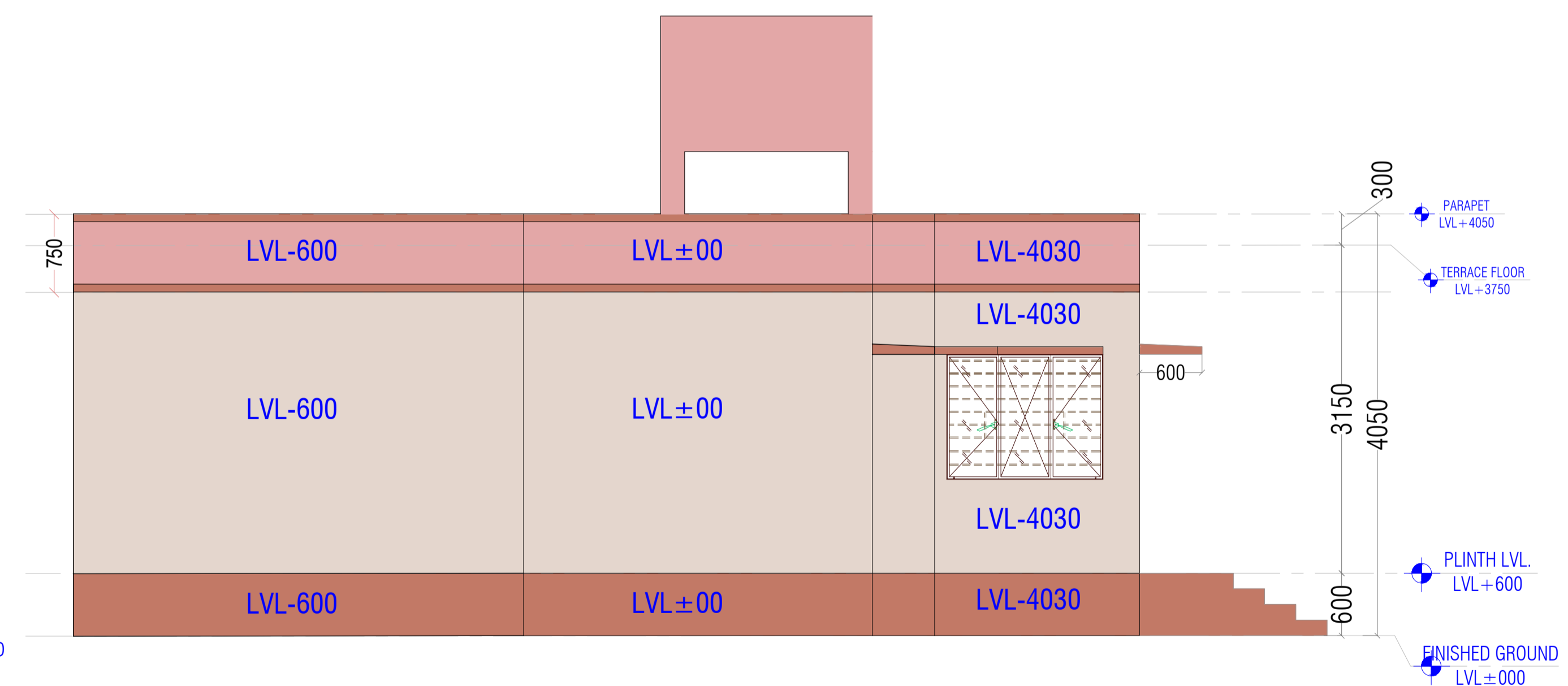

BEDROOM SIDE ELEVATION

CATEGORY : GIRLS WARDEN RESIDENCE

DRAWING TITLE : ELEVATIONS

DWG. NO.-
EMRS NAME/GWR/AR_03

DATE - 09 MARCH 2023

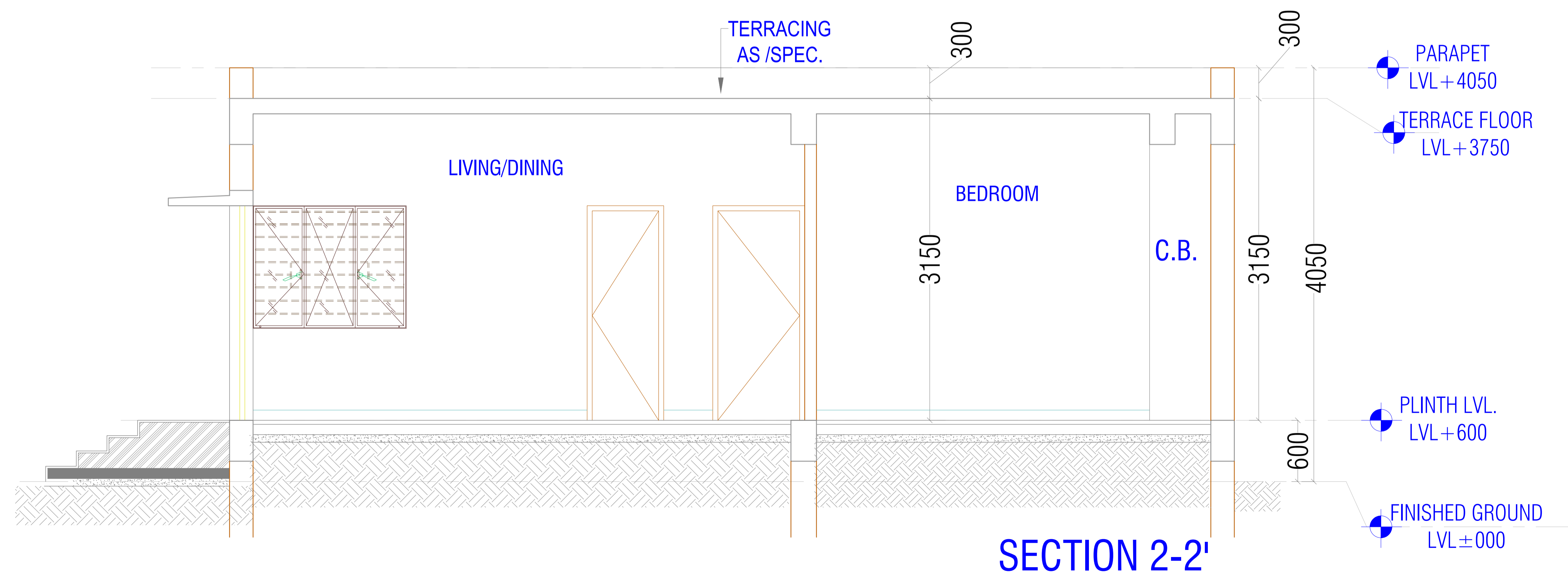
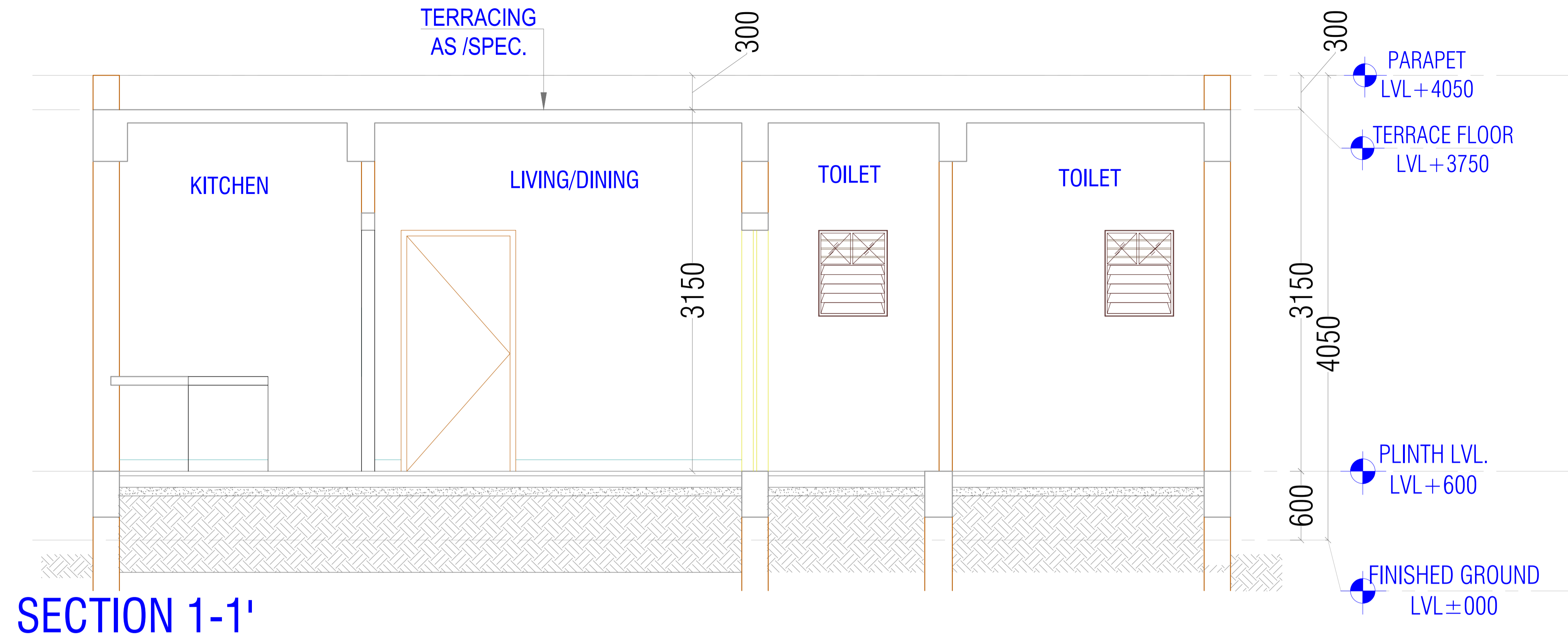

CATEGORY : WARDEN RESIDENCE

DRAWING TITLE : SECTION

DWG. NO.-
EMRS NAME/WR/AR_04

DATE - 09 MARCH 2023

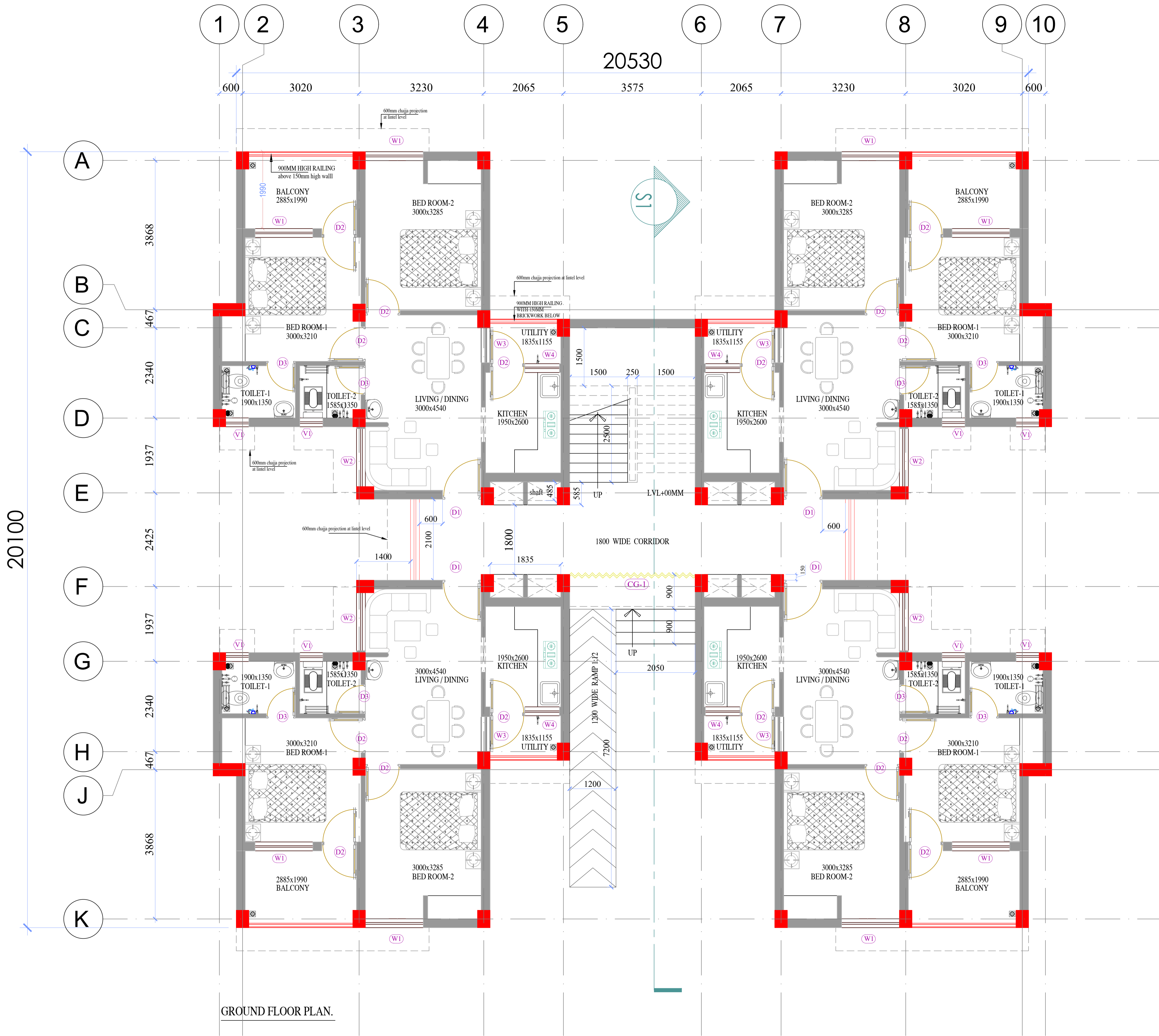

GROUND FLOOR PLAN.

PROJECT - EMRS
 CONSTRUCTION OF SCHOOL BUILDING FOR EKLAVYA MODEL RESIDENTIAL SCHOOL (EMRS)
 CLIENT -
GOVERNMENT OF INDIA
MINISTRY OF TRIBAL AFFAIRS
NATIONAL EDUCATION SOCIETY FOR TRIBAL STUDENTS



PER UNIT AREA INCLUDING CORRIDOR - 70 SQMT

| TYPE 2 | | | | | | | | | |
|--------|--------------------|------------|---------------|-------------|-----------------------------|----------|------------------------|-------------------------------|------------------|
| DOOR | WINDOW | VENTILATOR | FIXED GLAZING | GRILL | SCHEDULE FOR TYPE I QUARTER | | | | |
| TAG | CLEAR OPENING SIZE | SILL | INTEL | No. of nos. | Total area (sq. m) | LOCATION | MATERIAL | COMMENTS | |
| D1 | 1000 X 2100 | 0 | 2100 | 1 | 10 | 10 | MAIN ENTRANCE DOOR | FLUSH DOOR | SINGLE LEAF |
| D1 | 1000 X 2100 | 0 | 2100 | 4 | 4 | 4 | TERRACE DOOR | MS SHEET DOOR | SINGLE LEAF |
| D2 | 900 X 2100 | 0 | 2100 | 2 | 10 | 20 | BEDROOM | FLUSH DOOR | SINGLE LEAF |
| D2 | 900 X 2100 | 0 | 2100 | 2 | 10 | 20 | BALCONY, UTILITY | LAMINATED DOOR WITH WIRE MESH | SINGLE LEAF |
| D3 | 750 X 2100 | 0 | 2100 | 2 | 10 | 20 | TOILET DOOR | PRESSED LAMINATED DOOR | SINGLE LEAF |
| W1 | 1500 X 1350 | 750 | 2100 | 2 | 10 | 20 | BEDROOM-1, BEDROOM-2 | STEEL GLAZED WINDOW | |
| W2 | 1500 X 1200 | 900 | 2100 | 1 | 10 | 10 | LIVING / DINING HALL | STEEL GLAZED WINDOW | |
| W3 | 900 X 1200 | 900 | 2100 | 1 | 10 | 10 | LIVING / DINING HALL | STEEL GLAZED WINDOW | |
| W4 | 900 X 1050 | 1050 | 2100 | 1 | 10 | 10 | KITCHEN | STEEL GLAZED WINDOW | |
| V1 | 600 X 600 | 1500 | 2100 | 2 | 10 | 20 | TOILET | STANDARD STEEL SECTION | |
| CG-1 | 3250 X 2100 | 0 | 2100 | 1 | 1 | 1 | BLOCK FRONT ENTRY GATE | STANDARD STEEL SECTION | COLLAPSIBLE GATE |

CATEGORY : TYPE II QUARTER

DRAWING TITLE : GROUND FLOOR PLAN

DWG. NO.- EMRS NAME/TYPE-II/AR_01

DATE - 09 MARCH 2023

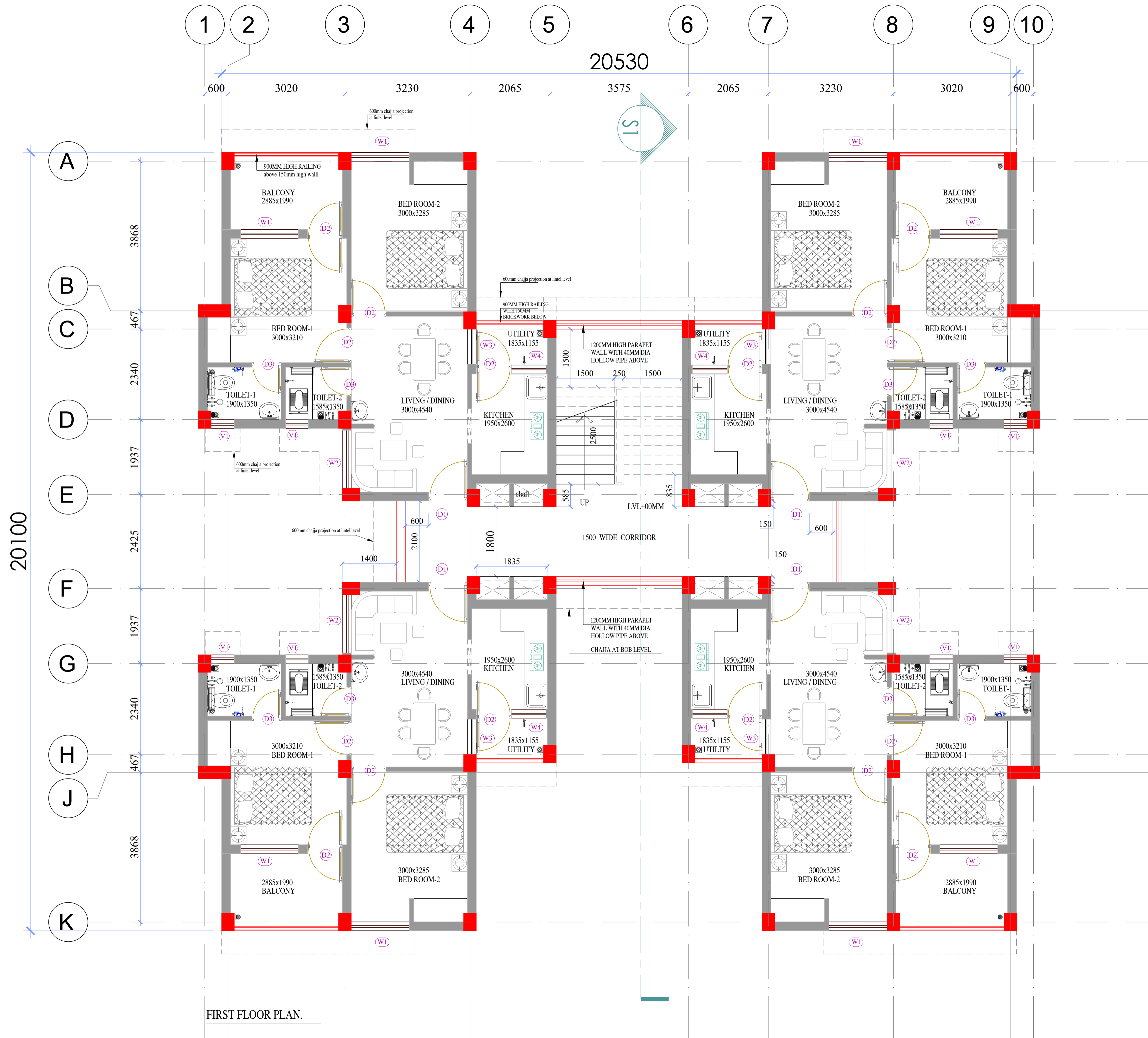

FIRST FLOOR PLAN.

CATEGORY : TYPE II QUARTER

DRAWING TITLE : FIRST FLOOR PLAN

DWG. NO.- EMRS NAME/TYPE-II/AR_02

DATE - 09 MARCH 2023

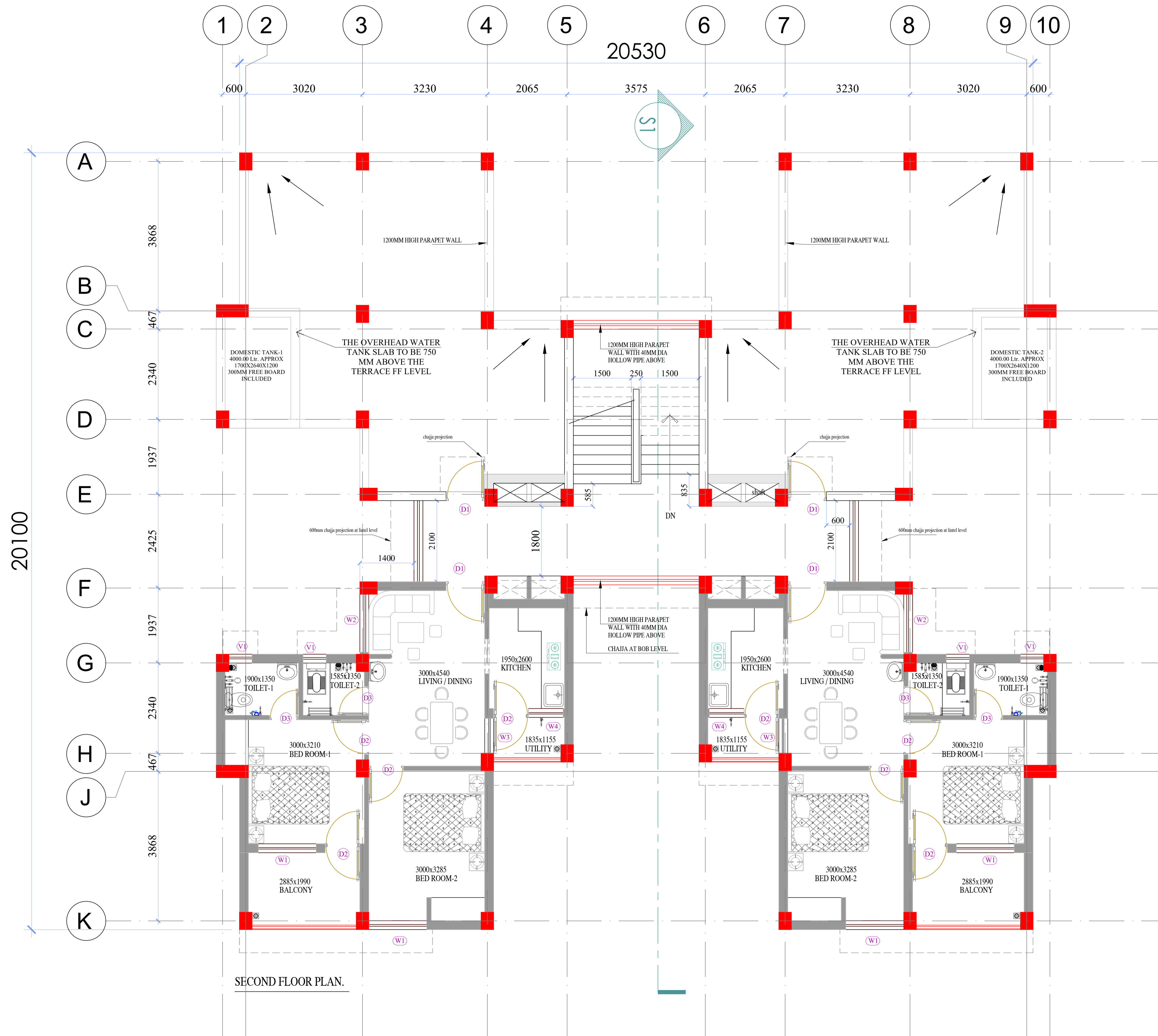

CATEGORY : TYPE II QUARTER

DRAWING TITLE : SECOND FLOOR PLAN

DWG. NO.- EMRS NAME/TYPE-II/AR_03

DATE - 09 MARCH 2023

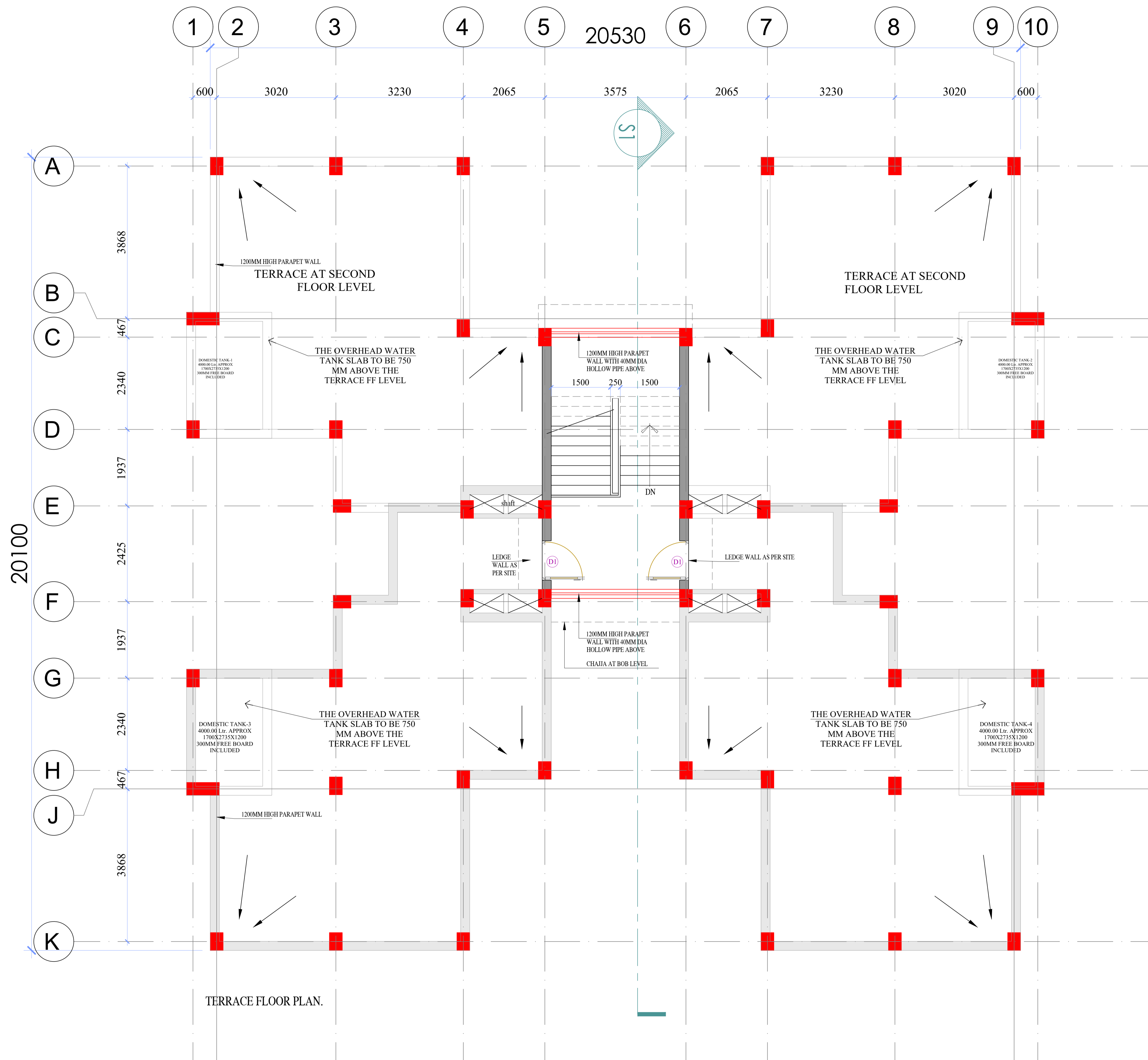
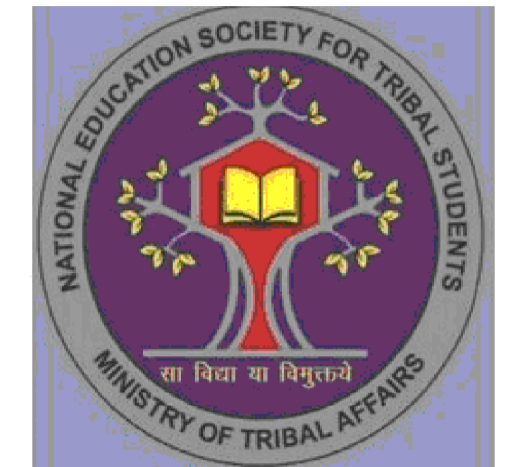

CATEGORY : TYPE II QUARTER

DRAWING TITLE : TERRACE FLOOR PLAN

DWG. NO.- EMRS NAME/TYPE-II/AR_04

DATE - 09 MARCH 2023



FRONT ELVATION

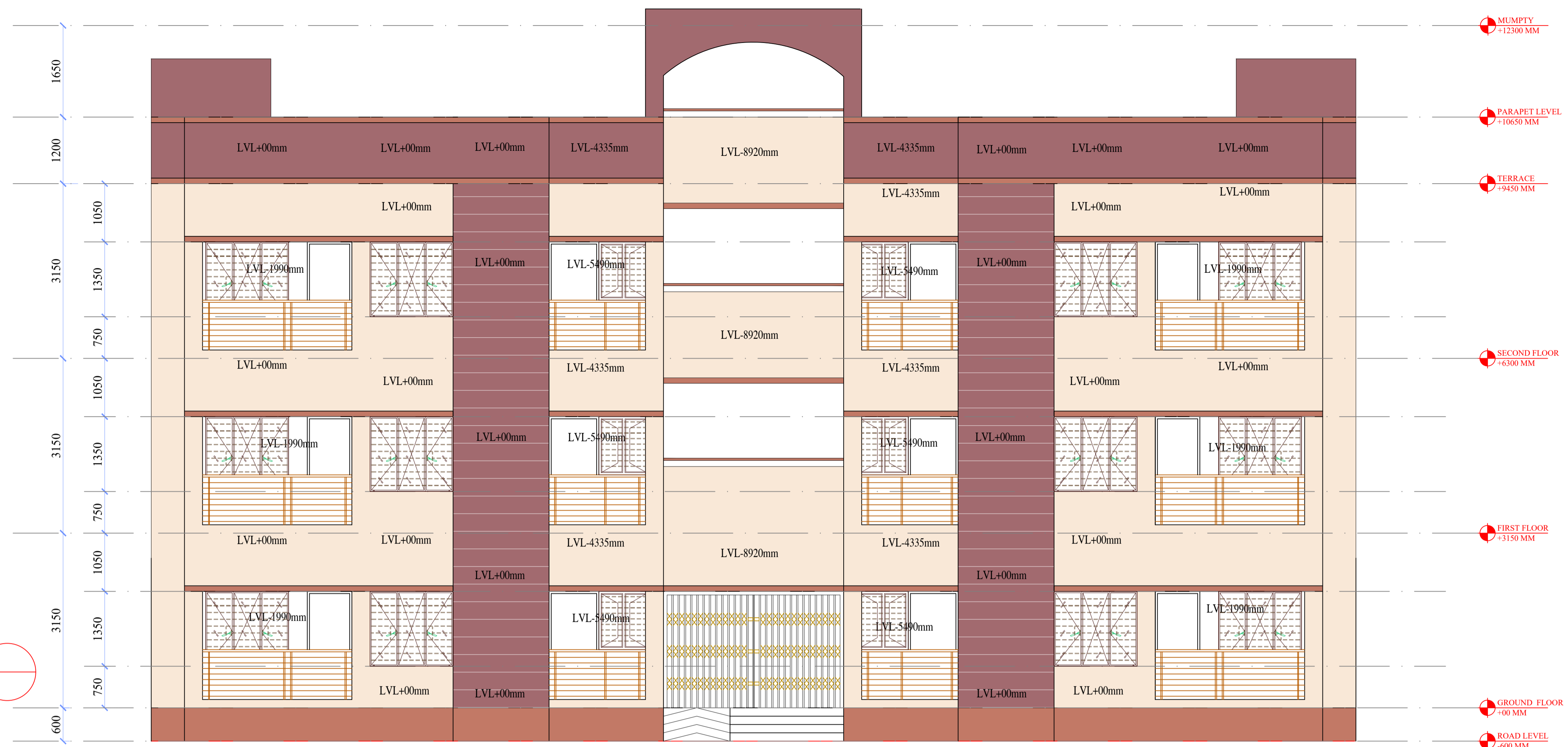

SIDE ELVATION





SECTION : S1

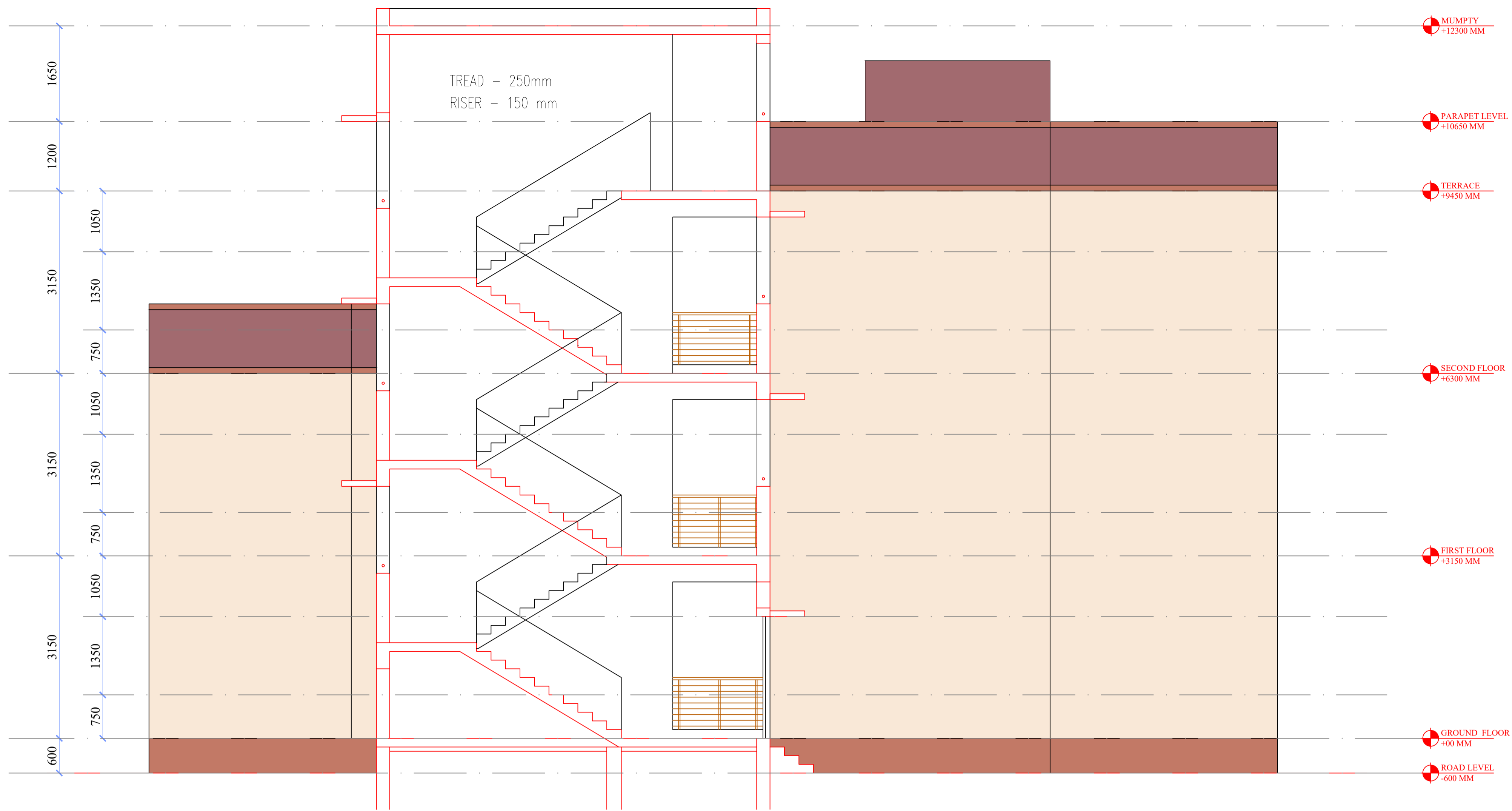

REAR ELVATION





PER UNIT AREA INCLUDING
CORRIDOR - 80 SQMT

| TYPE III | | | | | | | | | |
|--|--------------------|------|--------|-----------------|------------------|----------|------------------------|---|------------------|
| DOOR, WINDOW, VENTILATOR, FIXED GLAZING, GRILL SCHEDULE FOR TYPE III QUARTER | | | | | | | | | |
| TAG | CLEAR OPENING SIZE | SILL | LINTEL | No. (for 1 sqm) | Total nos. (sqm) | LOCATION | MATERIAL | COMMENTS | |
| D1 | 1000 X 2100 | 0 | 2100 | 1 | 16 | 16 | MAIN ENTRANCE DOOR | FLUSH DOOR | SINGLE LEAF |
| D1 | 1000 X 2100 | 0 | 2100 | 2 | 2 | 4 | TERRACE DOOR | MS SHEET DOOR | SINGLE LEAF |
| D2 | 900 X 2100 | 0 | 2100 | 2 | 16 | 32 | BEDROOM | FLUSH DOOR | SINGLE LEAF |
| D2 | 900 X 2100 | 0 | 2100 | 2 | 16 | 32 | UTILITY BALCONY | PRELAMINATED DOOR WITH WIRE MESH FACTORY PRESSED LAMINATED DOOR | SINGLE LEAF |
| D3 | 750 X 2100 | 0 | 2100 | 2 | 16 | 32 | TOILET DOOR | | SINGLE LEAF |
| W1 | 1500 X 1350 | 750 | 2100 | 2 | 16 | 32 | BEDROOM-1 | STEEL GLAZED WINDOW | |
| W2 | 1500 X 1200 | 900 | 2100 | 1 | 16 | 16 | LIVING / DINING HALL | STEEL GLAZED WINDOW | |
| W3 | 900 X 1200 | 900 | 2100 | 1 | 16 | 16 | LIVING / DINING HALL | STEEL GLAZED WINDOW | |
| W4 | 900 X 1050 | 1050 | 2100 | 1 | 16 | 16 | KITCHEN | STEEL GLAZED WINDOW | |
| V1 | 600 X 600 | 1500 | 2100 | 2 | 16 | 32 | TOILET | STANDARD STEEL SECTION | |
| CG-1 | 3250 X 2100 | 0 | 2100 | 1 | 2 | 2 | BLOCK FRONT ENTRY GATE | STANDARD STEEL SECTION | COLLAPSIBLE GATE |

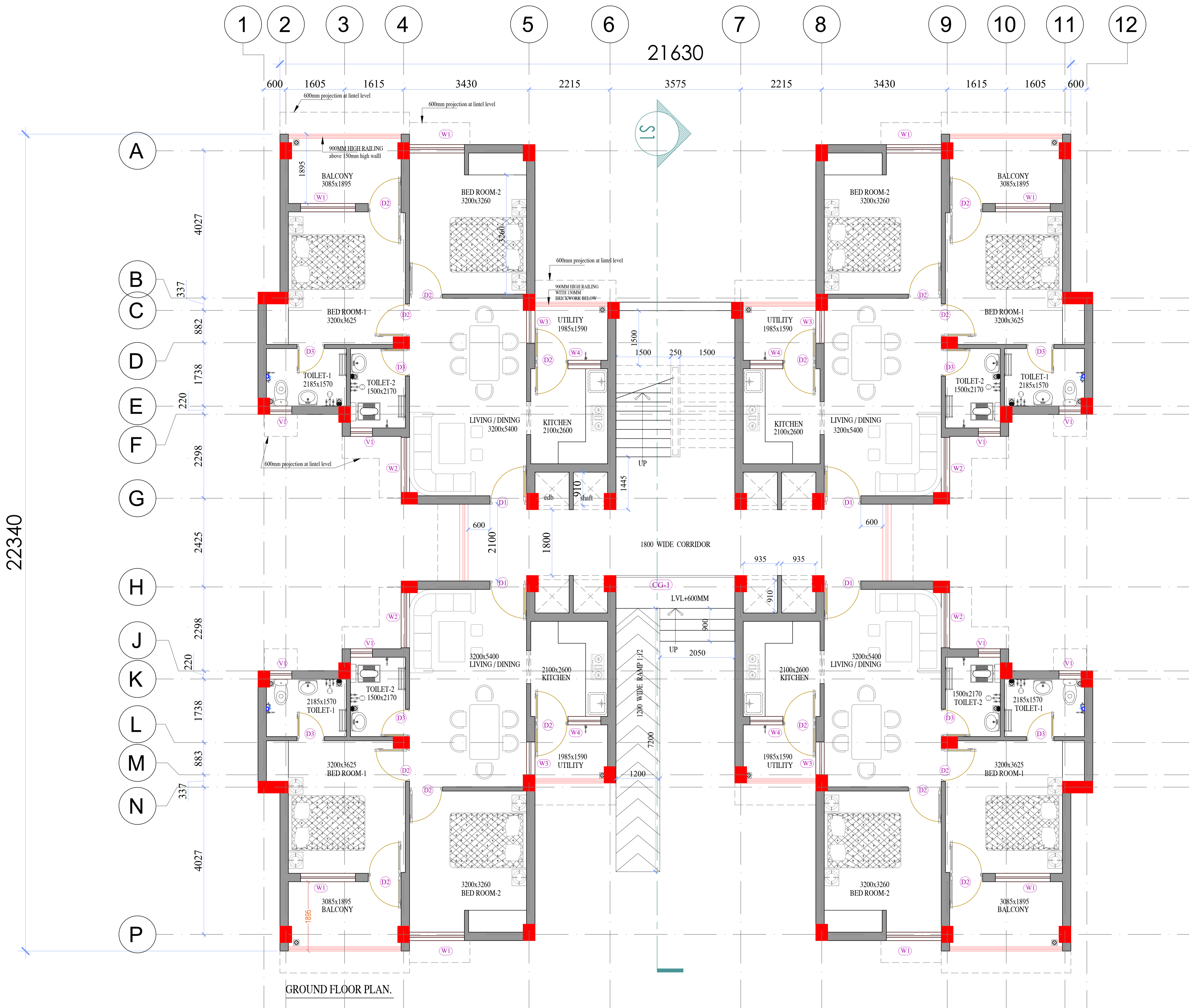

GROUND FLOOR PLAN.

CATEGORY : TYPE III QUARTER

DRAWING TITLE : GROUND FLOOR PLAN

DWG. NO.- EMRS NAME/TYPE-III/AR_01

DATE - 09 MARCH 2023

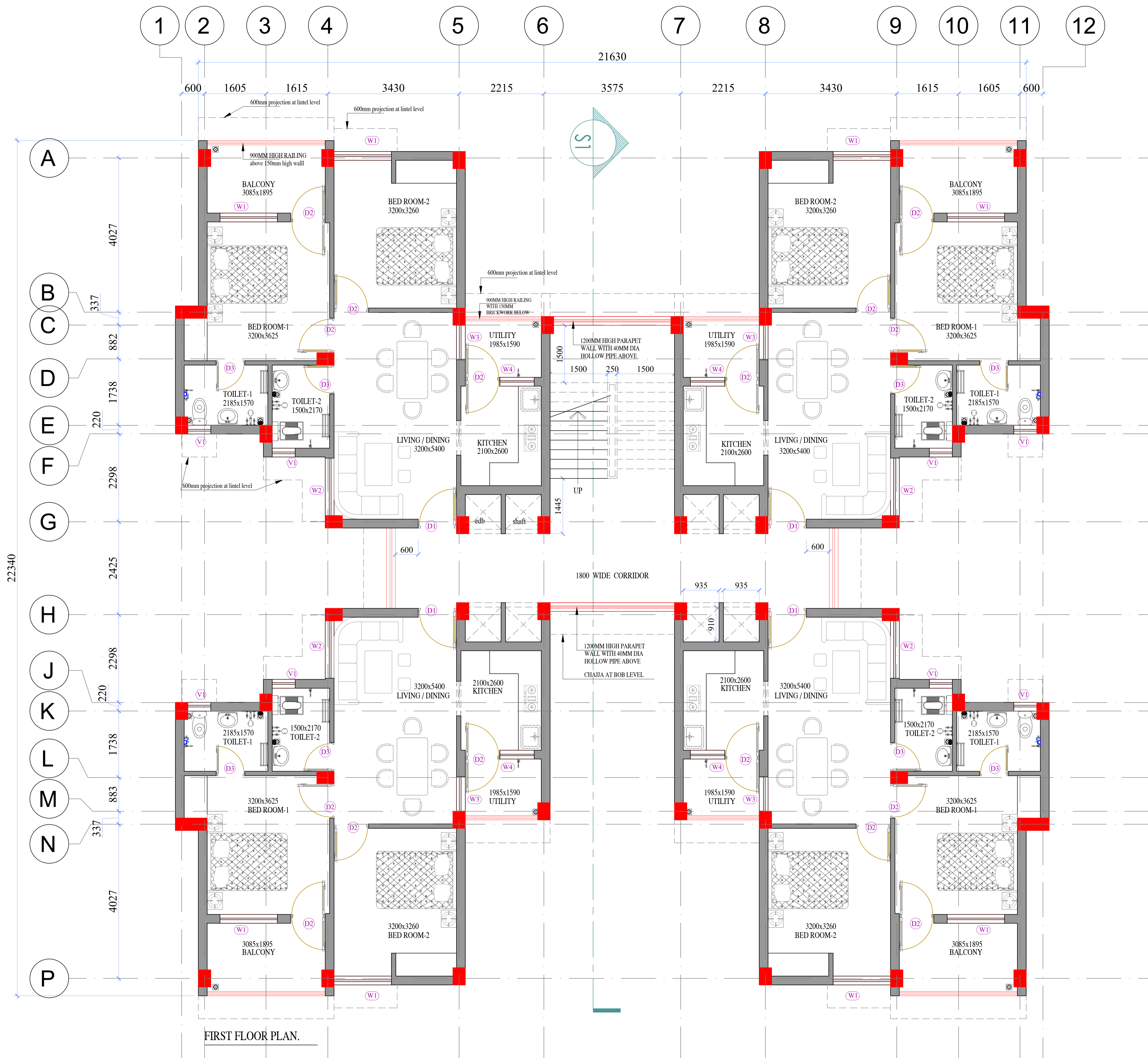

FIRST FLOOR PLAN.

CATEGORY : TYPE III QUARTER

DRAWING TITLE : FIRST FLOOR PLAN

DWG. NO.- EMRS NAME/TYPE-III/AR_02

DATE - 09 MARCH 2023

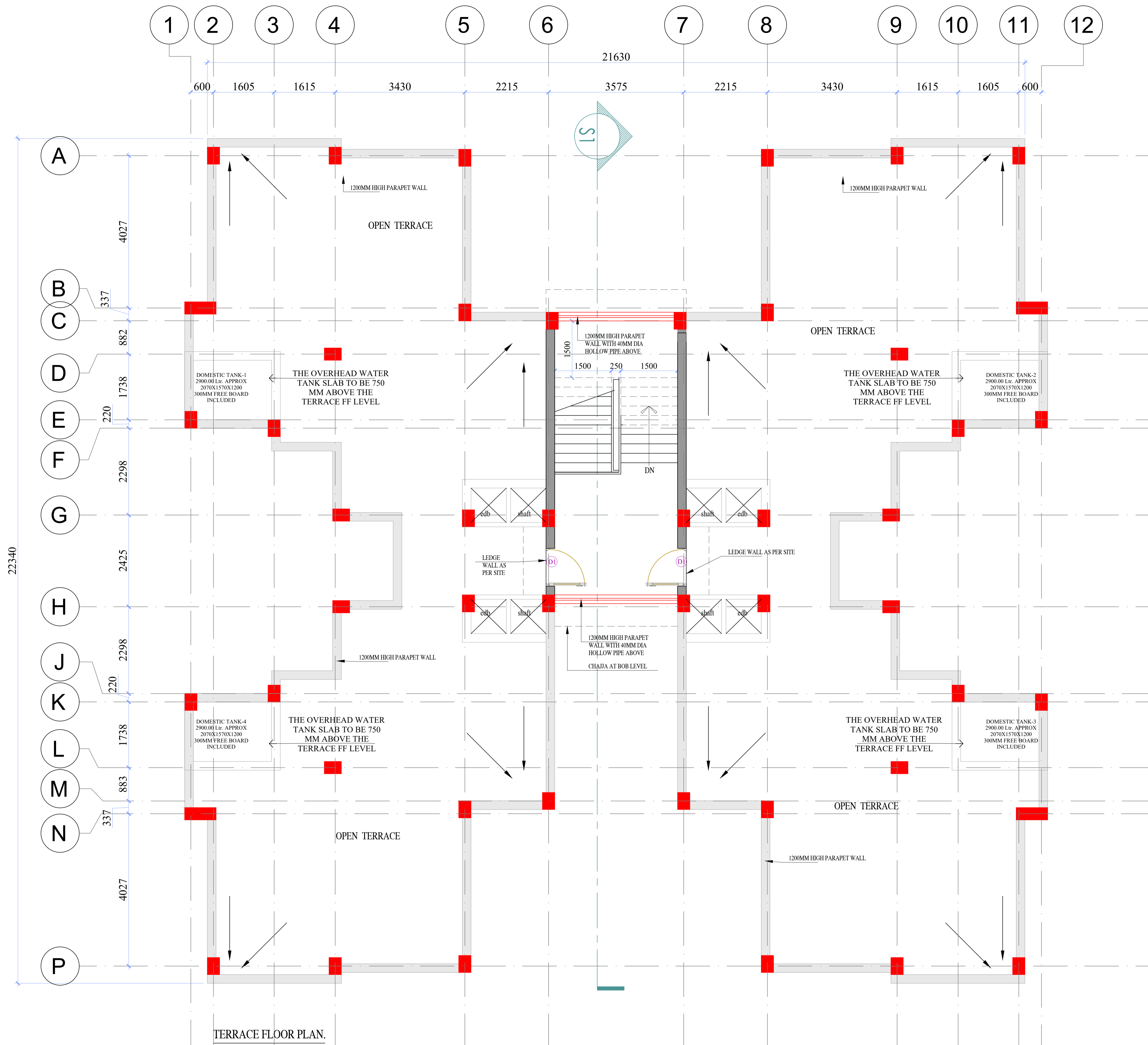

CATEGORY : TYPE III QUARTER

DRAWING TITLE : TERRACE FLOOR PLAN

DWG. NO.- EMRS NAME/TYPE-III/AR_03

DATE - 09 MARCH 2023

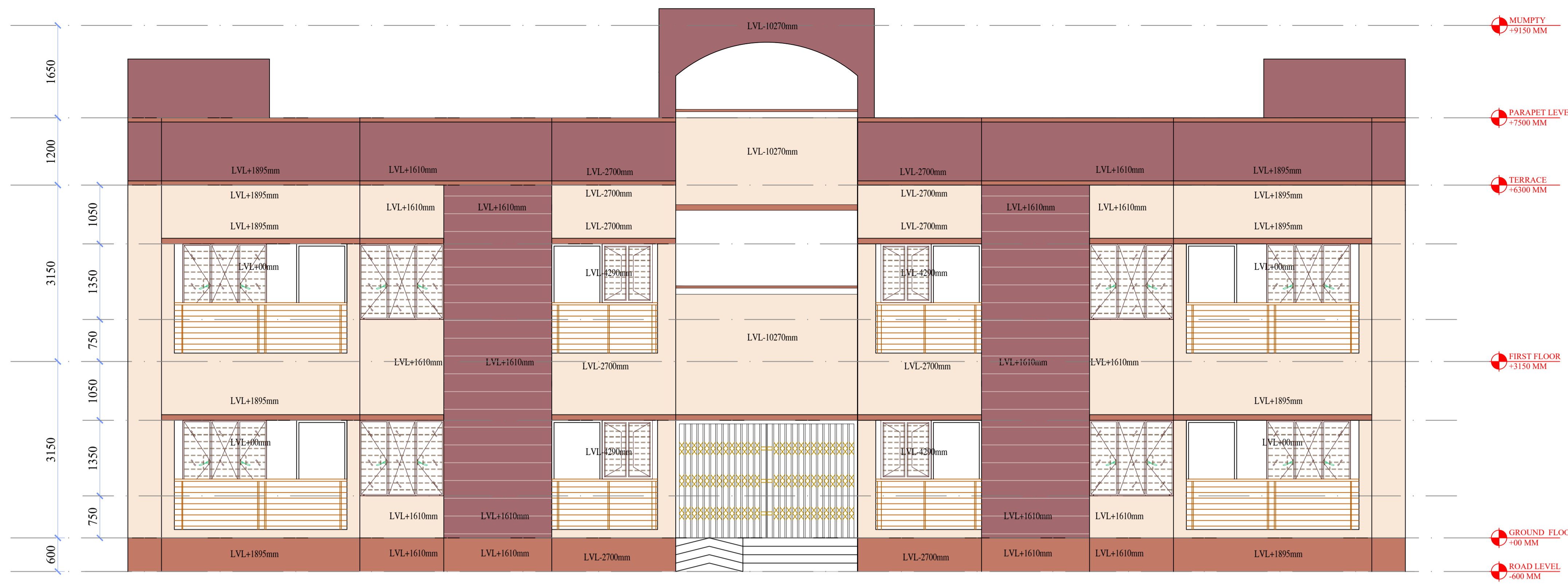

FRONT ELVATION

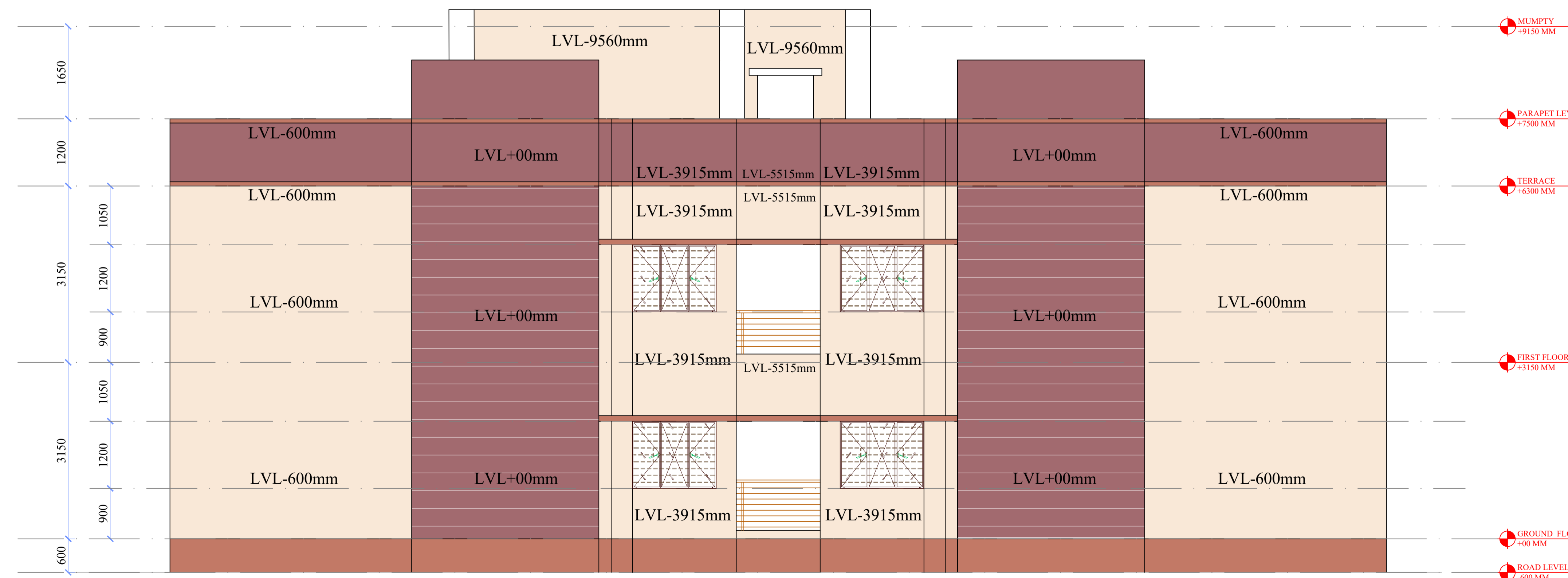
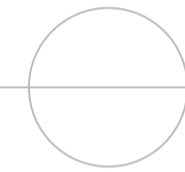

SIDE ELVATION

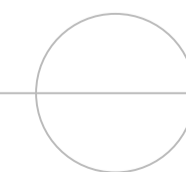

CATEGORY : TYPE III QUARTER

DRAWING TITLE : ELEVATION

DWG. NO.- EMRS NAME/TYPE-III/AR_04

DATE - 09 MARCH 2023

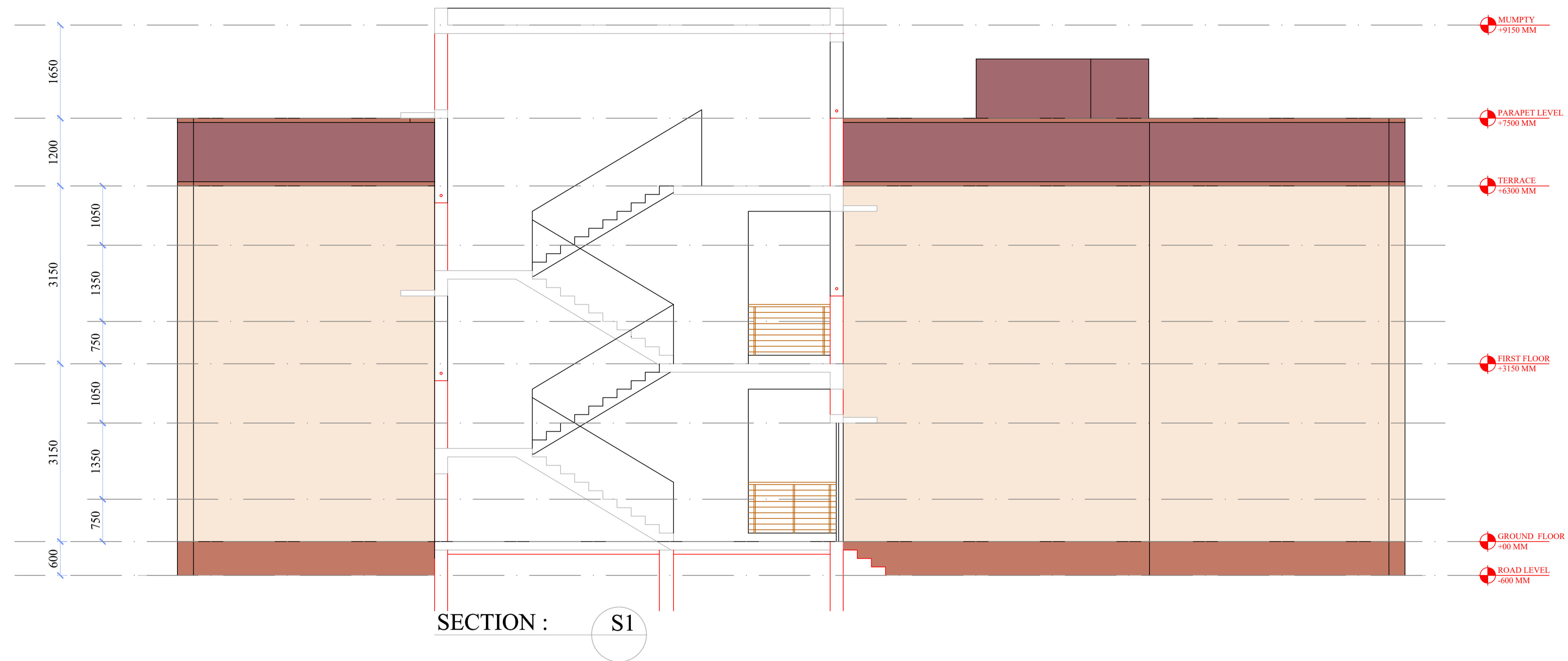

SECTION : S1

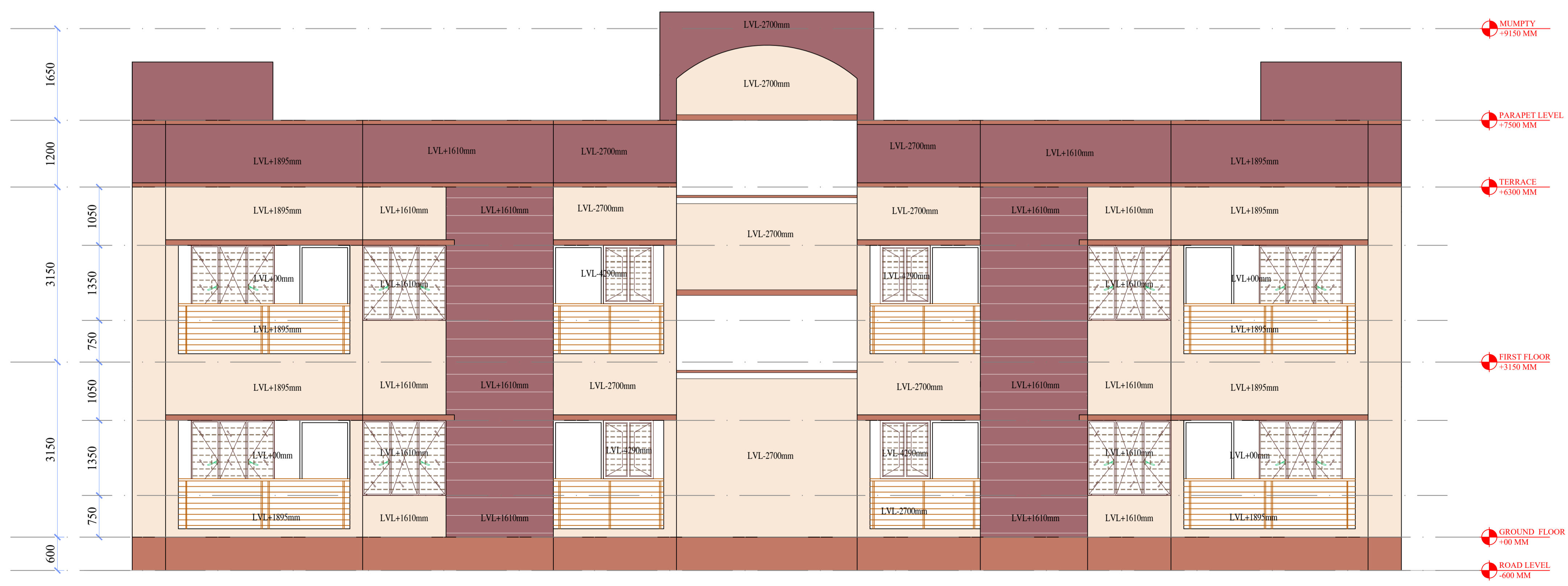

REAR ELEVATION

CATEGORY : TYPE III QUARTER

DRAWING TITLE : SECTION

DWG. NO.-
EMRS NAME/TYPE-III/AR_05

DATE - 09 MARCH 2023



UNIT AREA - 130 Sq. Mt.

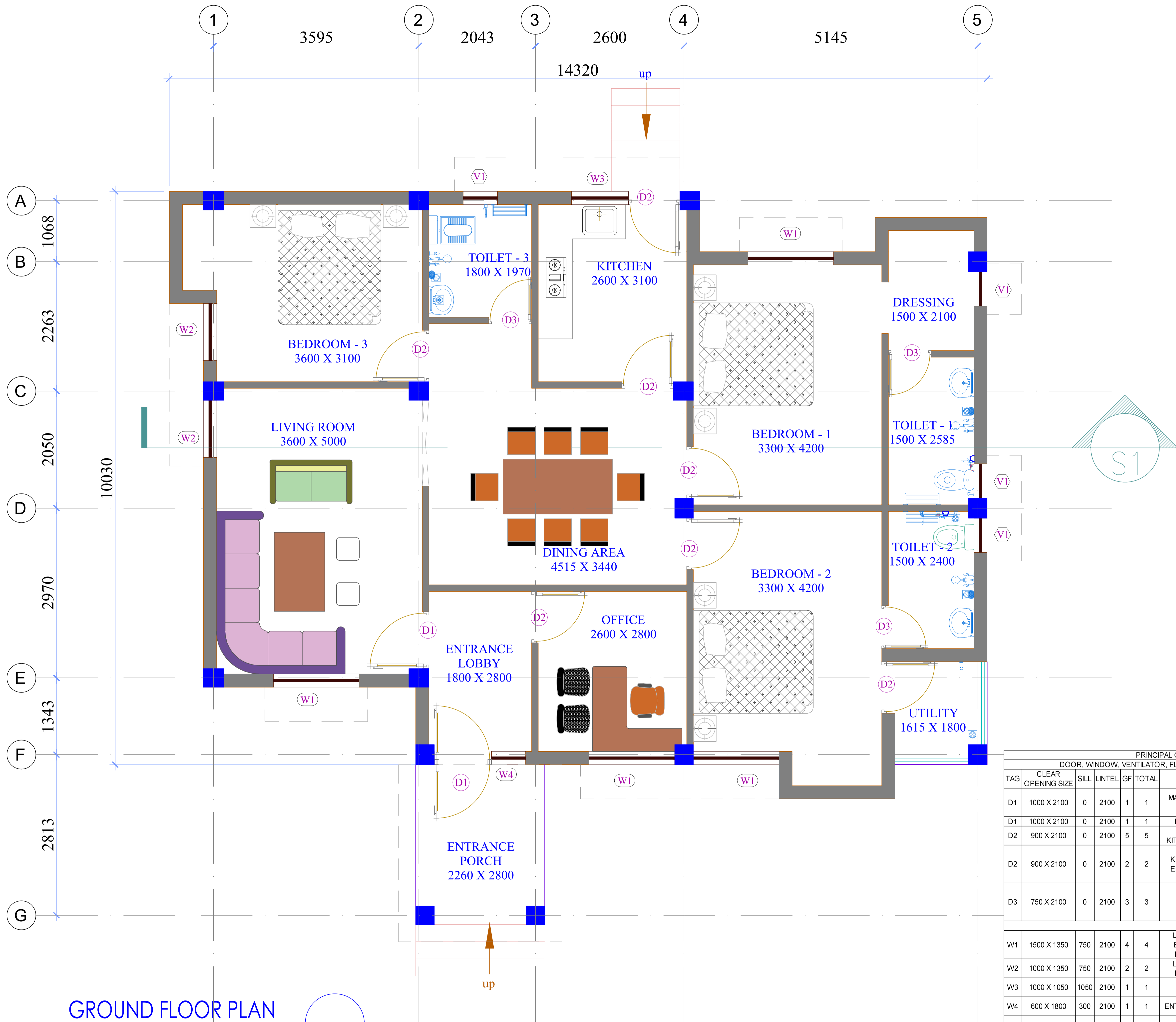

| PRINCIPAL QUARTER | | | | | | | | |
|---|--------------------|------|--------|----|-------|-----------------------------------|--------------------------------|----------------------------|
| DOOR, WINDOW, VENTILATOR, FIXED GLAZING, GRILL SCHEDULE | | | | | | | | |
| TAG | CLEAR OPENING SIZE | SILL | LINTEL | GF | TOTAL | LOCATION | MATERIAL | COMMENTS |
| D1 | 1000 X 2100 | 0 | 2100 | 1 | 1 | MAIN ENTRANCE DOOR | FLUSH DOOR | SINGLE LEAF WITH WIRE MESH |
| D1 | 1000 X 2100 | 0 | 2100 | 1 | 1 | LIVING ROOM | FLUSH DOOR | SINGLE LEAF |
| D2 | 900 X 2100 | 0 | 2100 | 5 | 5 | BEDROOM, KITCHEN, OFFICE | FLUSH DOOR | SINGLE LEAF |
| D2 | 900 X 2100 | 0 | 2100 | 2 | 2 | KITCHEN REAR ENTRY, UTILITY | FACTORY PRESSED LAMINATED DOOR | SINGLE LEAF |
| D3 | 750 X 2100 | 0 | 2100 | 3 | 3 | TOILET | FACTORY PRESSED LAMINATED DOOR | SINGLE LEAF |
| W1 | 1500 X 1350 | 750 | 2100 | 4 | 4 | LIVING ROOM, BEDROOM-1, BEDROOM-2 | STEEL GLAZED WINDOW | |
| W2 | 1000 X 1350 | 750 | 2100 | 2 | 2 | LIVING ROOM, BEDROOM-3 | STEEL GLAZED WINDOW | |
| W3 | 1000 X 1050 | 1050 | 2100 | 1 | 1 | KITCHEN | STEEL GLAZED WINDOW | |
| W4 | 600 X 1800 | 300 | 2100 | 1 | 1 | ENTRANCE LOBBY | STEEL GLAZED WINDOW | |
| V1 | 600 X 750 | 1350 | 2100 | 4 | 4 | TOILET | STANDARD STEEL SECTION | |

CATEGORY : PRINCIPAL QUARTER

DRAWING TITLE : GROUND FLOOR PLAN

DWG. NO.- EMRS NAME/PQ/AR_01

DATE - 09 MARCH 2023

GROUND FLOOR PLAN

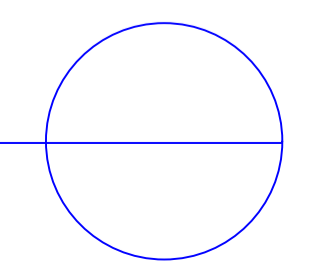

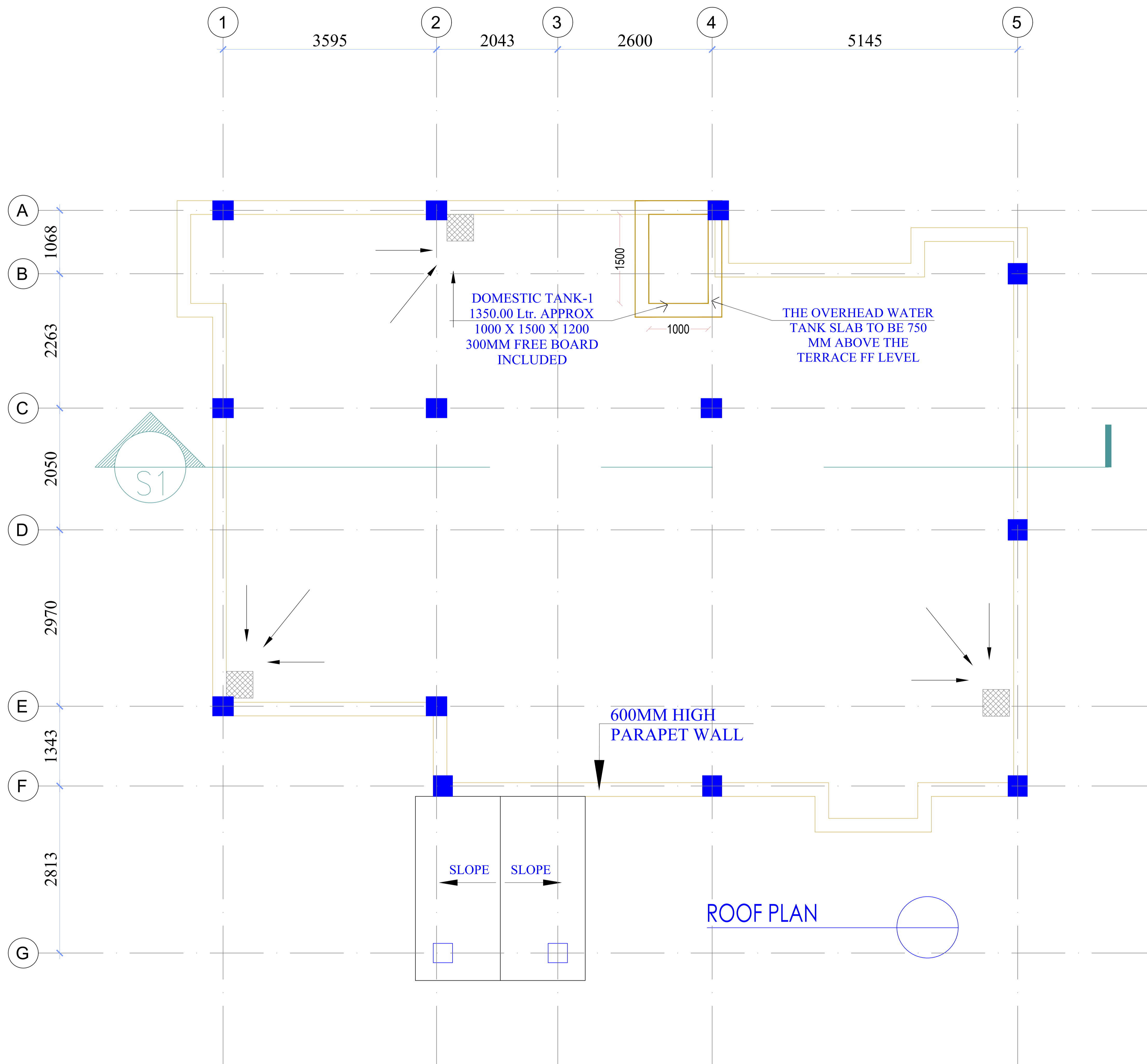

ROOF PLAN

CATEGORY : PRINCIPAL QUARTER

DRAWING TITLE : TERRACE FLOOR PLAN

DWG. NO.-
EMRS NAME/PQ/AR_02

DATE - 09 MARCH 2023



FRONT ELEVATION E-01

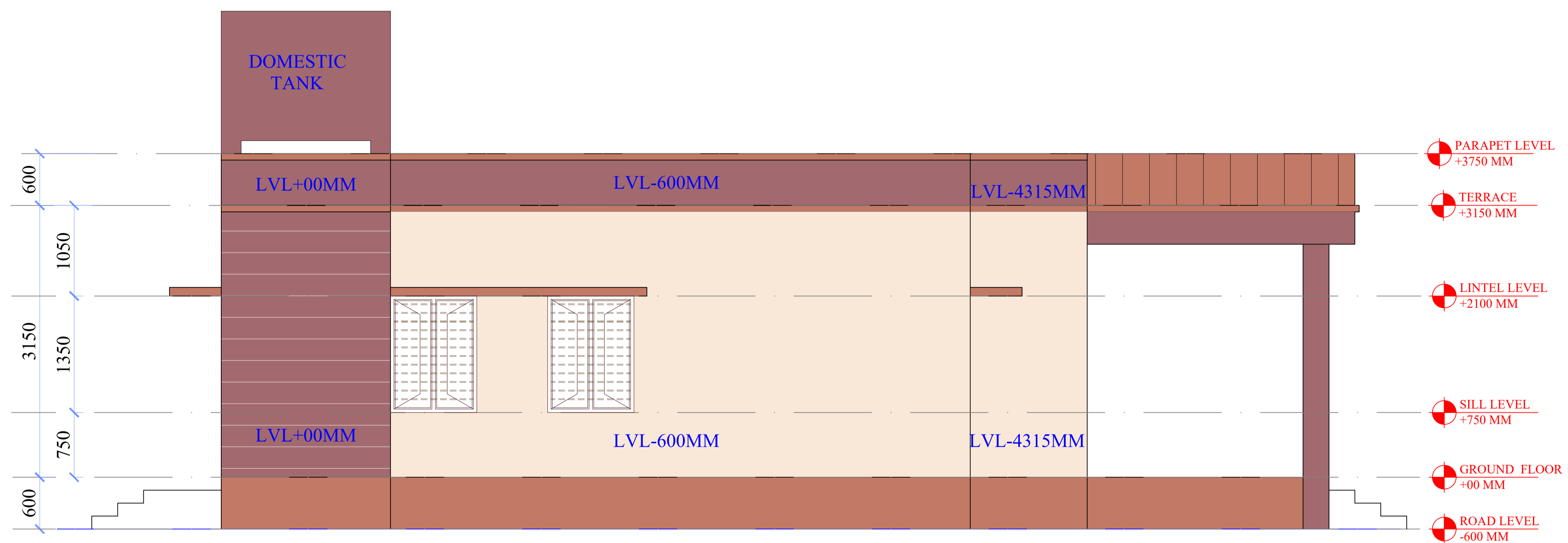

LEFT SIDE ELEVATION E-02

CATEGORY : PRINCIPAL QUARTER

DRAWING TITLE : ELEVATION

DWG. NO.-
EMRS NAME/PQ/AR_03

DATE - 09 MARCH 2023

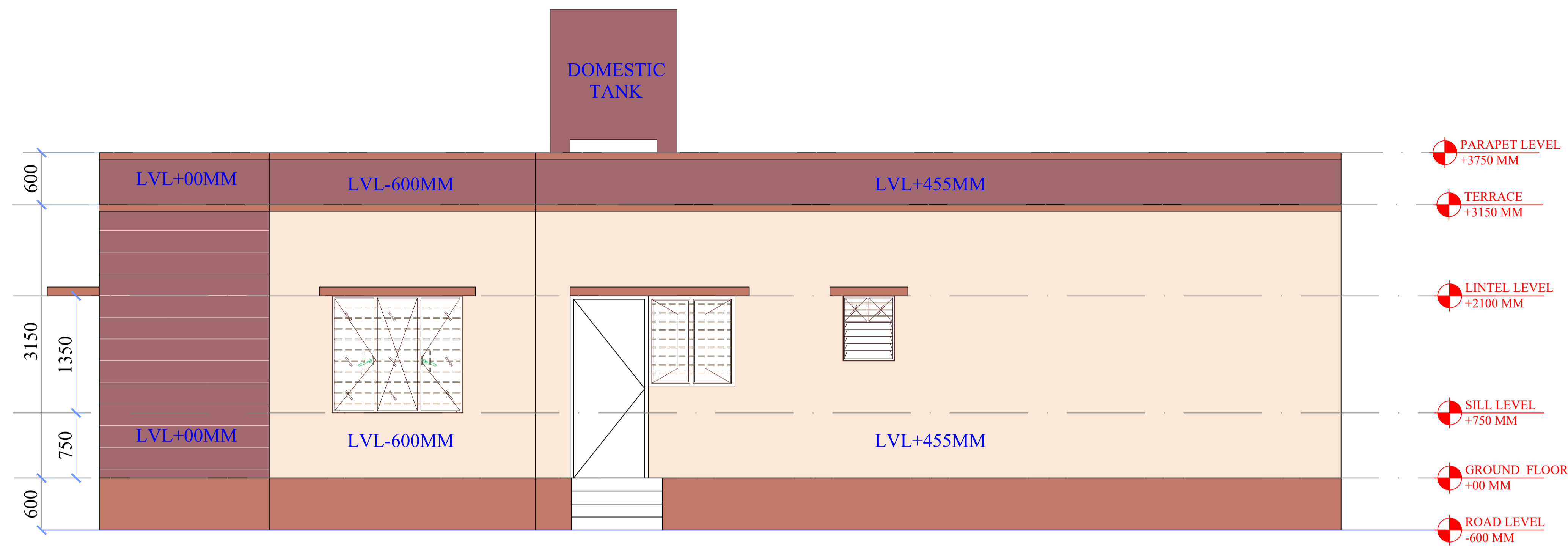

REAR SIDE ELEVATION E-03

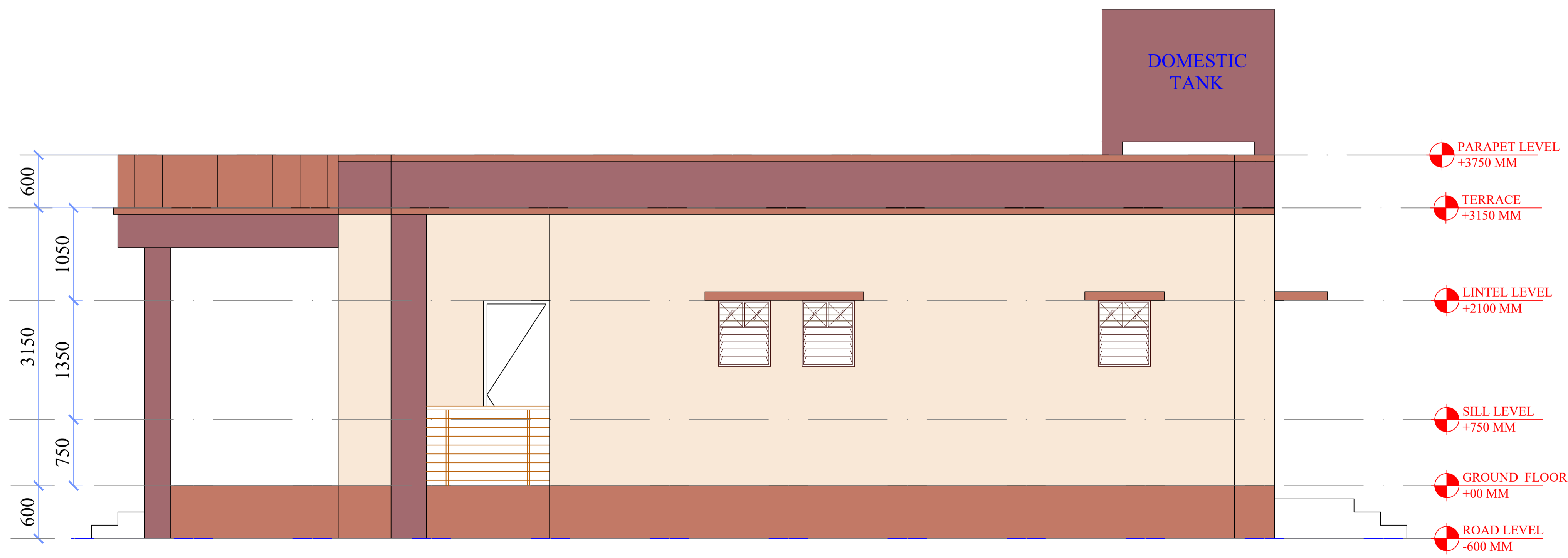

RIGHT SIDE ELEVATION E-04

CATEGORY : PRINCIPAL QUARTER

DRAWING TITLE : ELEVATION

DWG. NO.-
EMRS NAME/PQ/AR_04

DATE - 09 MARCH 2023

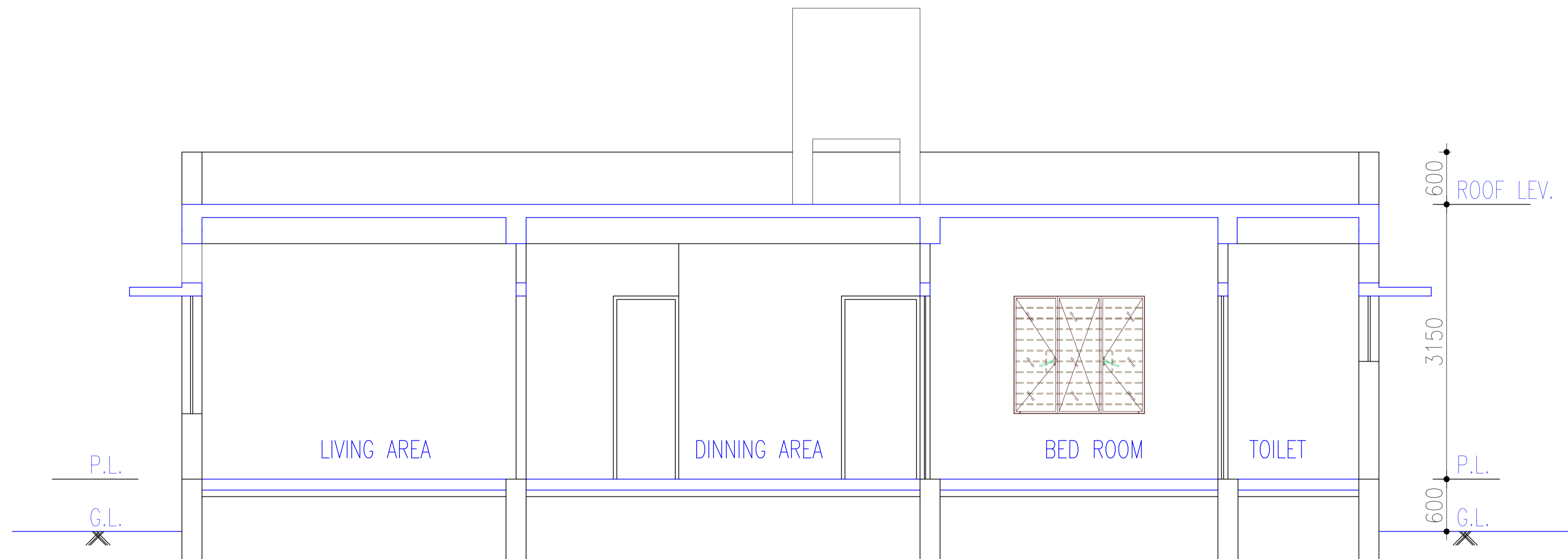

SECTION

S1
-

CATEGORY : PRINCIPAL QUARTER

DRAWING TITLE : SECTION

DWG. NO.-
EMRS NAME/PQ/AR_05

DATE - 09 MARCH 2023

CONSTRUCTION OF SCHOOL BUILDING FOR EKLAVYA MODEL RESIDENTIAL SCHOOL (EMRS)

CLIENT -

**GOVERNMENT OF INDIA
MINISTRY OF TRIBAL AFFAIRS
NATIONAL EDUCATION SOCIETY FOR TRIBAL STUDENTS**

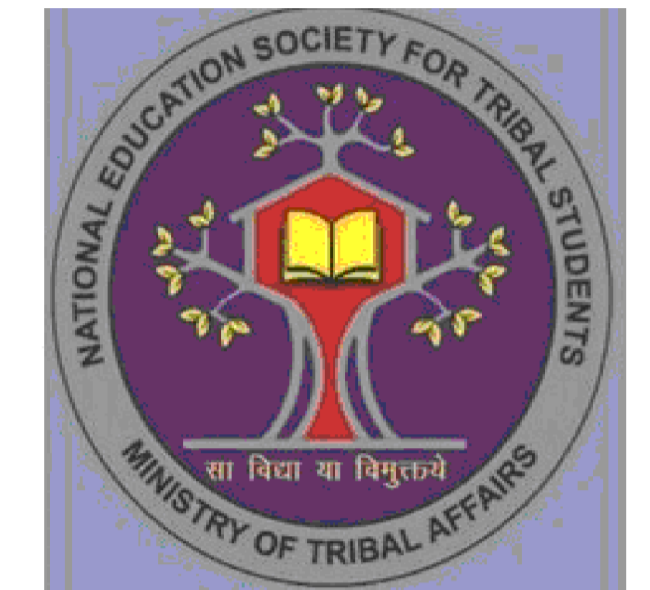

| DOOR, WINDOW SCHEDULE | | | | |
|-----------------------|--------------------|------|--------|----|
| TAG | CLEAR OPENING SIZE | SILL | LINTEL | GF |
| D1 | 1200 X 2400 | 0 | 2400 | 2 |
| RS | 2500 X 3000 | 0 | 3000 | 5 |
| W1 | 1500 X 1650 | 750 | 2400 | 4 |

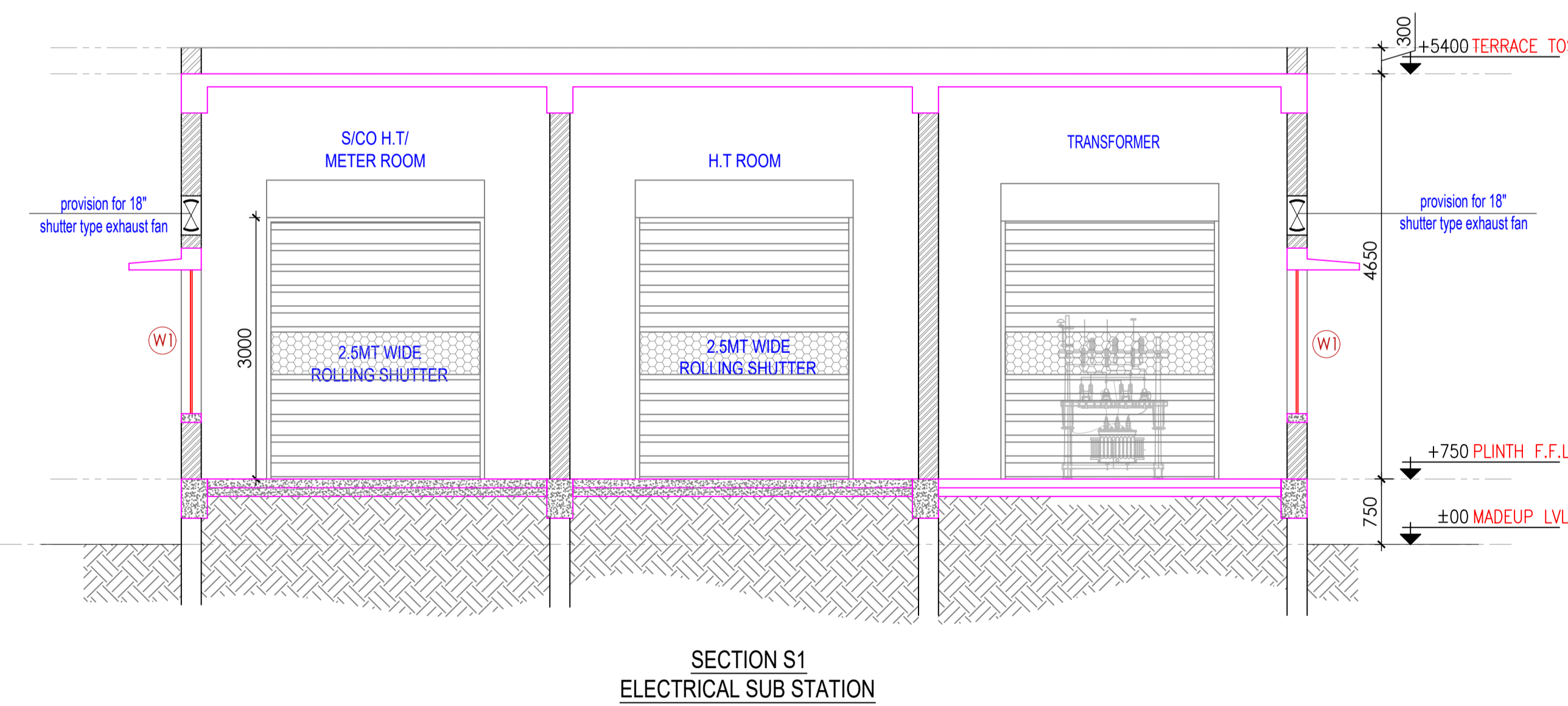
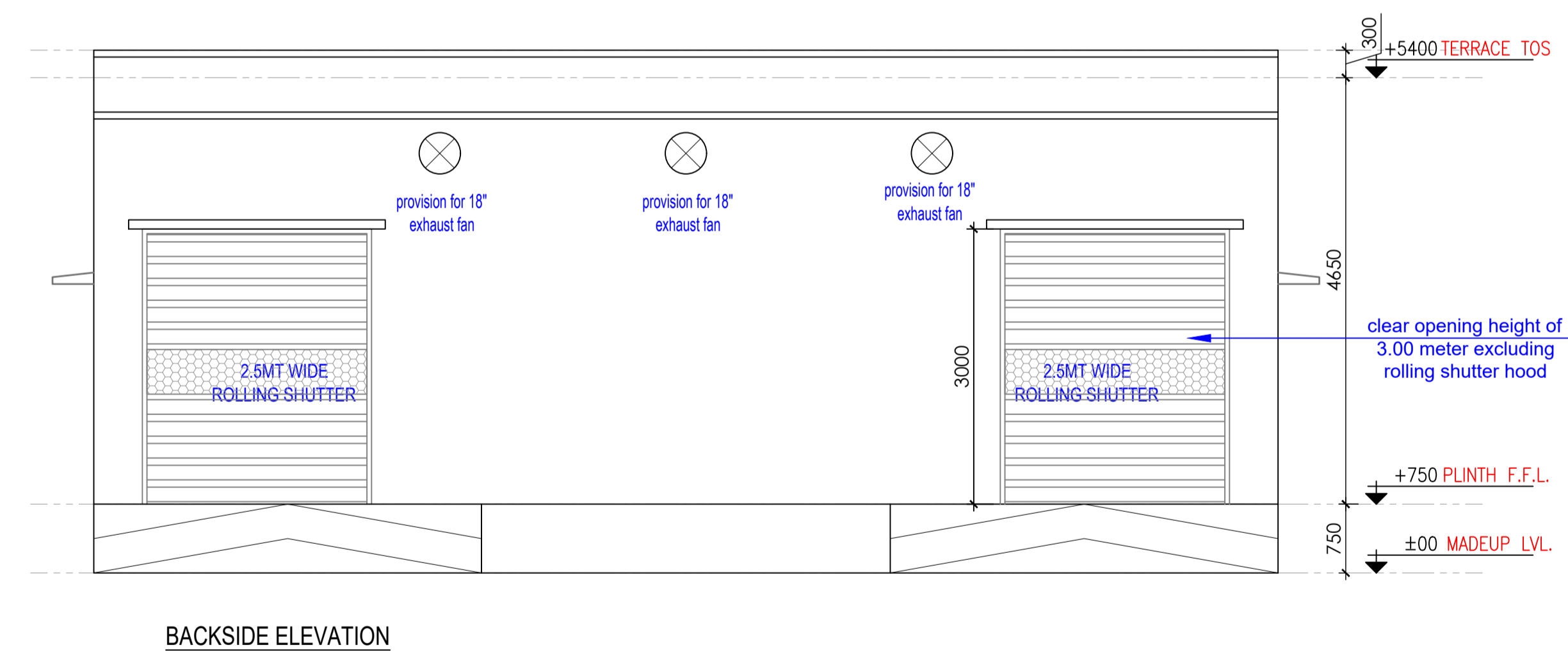
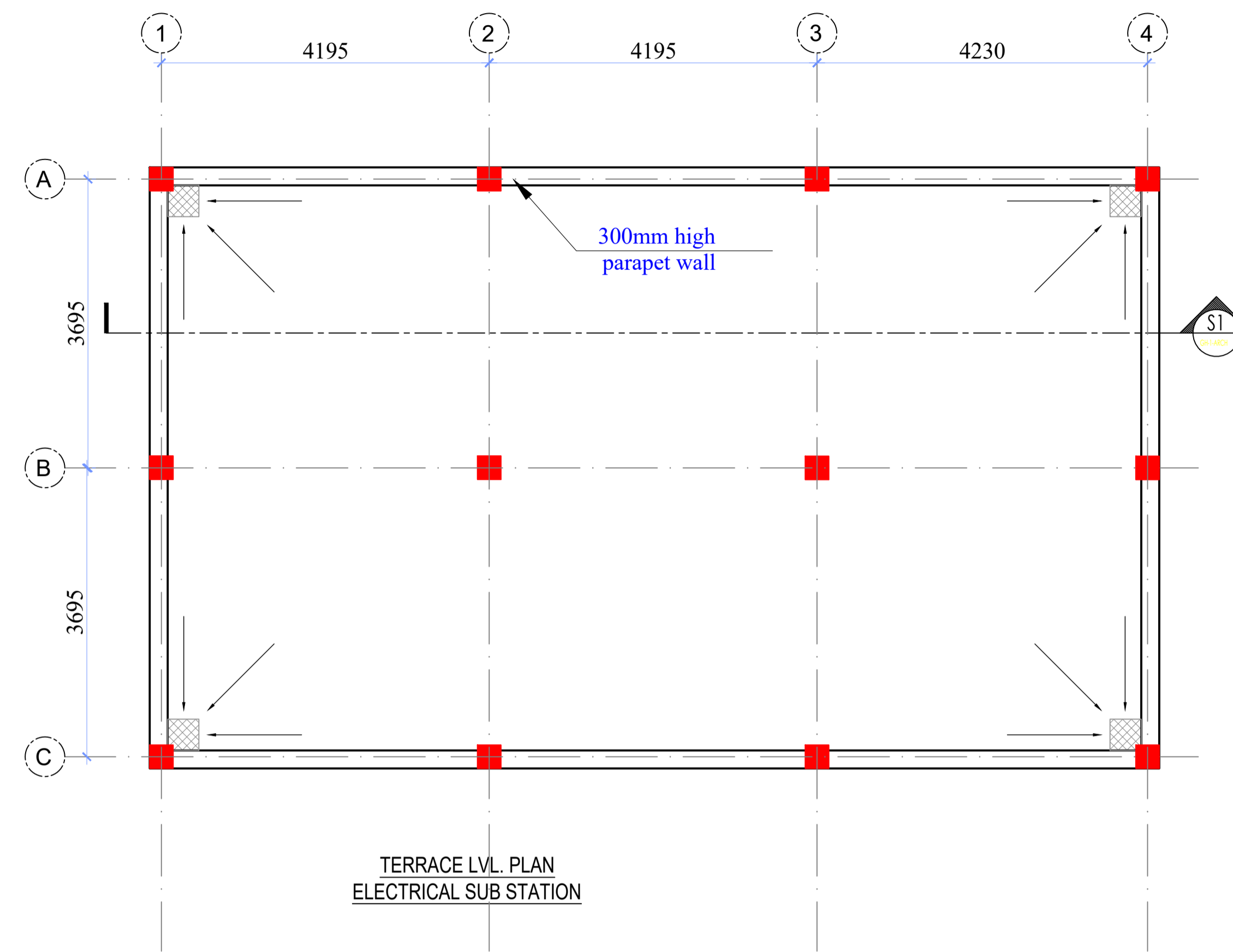
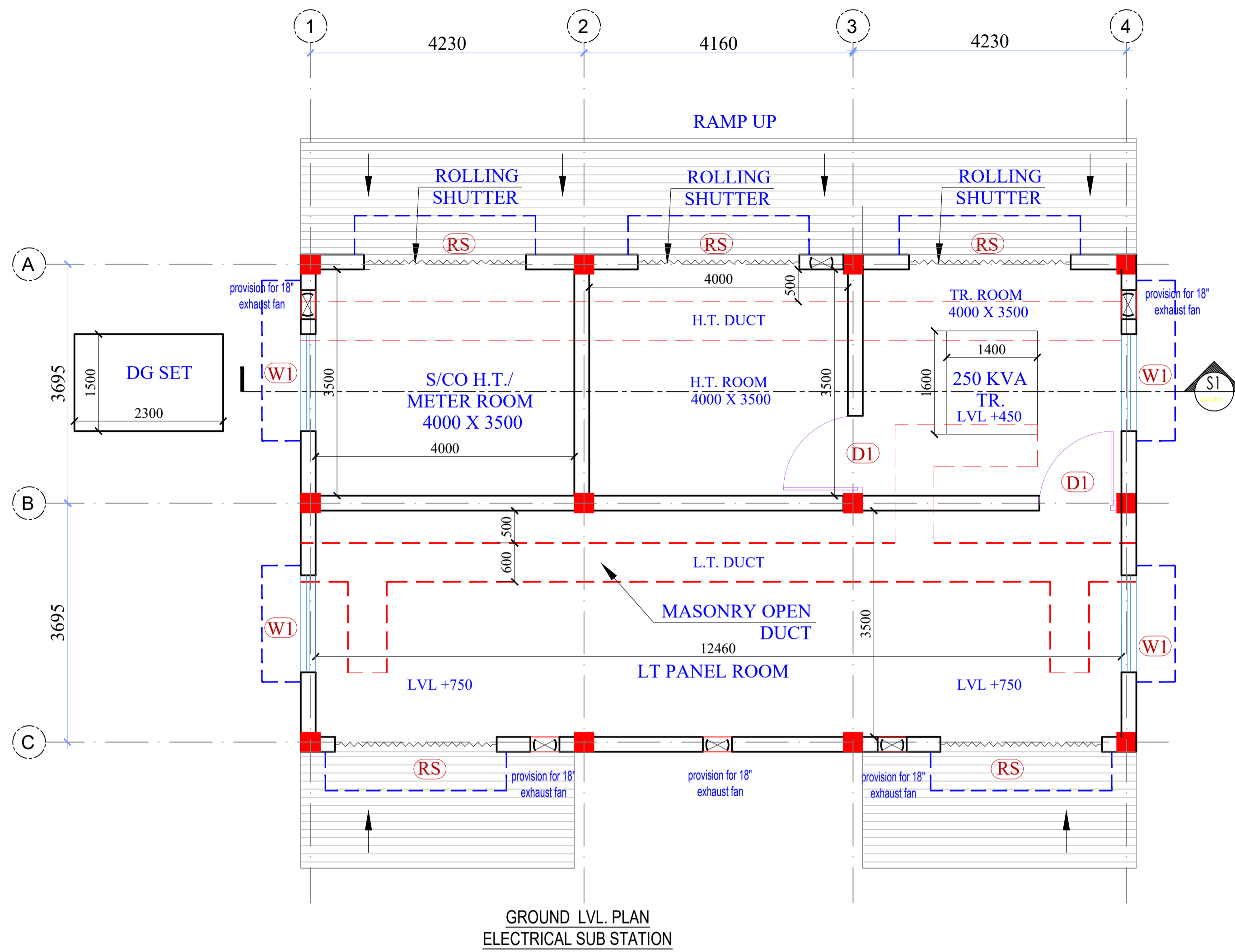

GROUND FLOOR BUILT-UP AREA- 99.35 SQMT

CATEGORY : SUB STATION

DRAWING TITLE : PLAN, ELEVATION, SECTION

DWG. NO.- EMRS NAME/SUB/AR_01

DATE - 09 MARCH 2023

SECTION – IX

FINANCIAL PROPOSAL

SUMMARY OF COST FOR PERCENTAGE RATE TENDER

| Description | Percentage Quoted (Excess / Less / at par) | Total Amount as per % Quoted (Excluding GST) (Rs.) |
|--|--|--|
| Construction of Eklavya Model Residential School at Jaldega, District Simdega, Jharkhand | DO NOT FILL PERCENTAGE HERE | DO NOT FILL COST HERE |
| Total amount in words: | | |
| DO NOT FILL COST HERE AS IT IS TECHNICAL PROPOSAL FILE | | |

Note:-

- *The Performa for filling the percentage rate is given in Microsoft excel sheet. Bidder shall fill the percentage only up to two decimal place in soft format. The bidder will upload same filled percentage quote in soft Microsoft Excel copy during uploading of financial bid.*
- *The Bidder shall quote Percentage up to two decimal only in bill of quantity of tender.*
- Prices quoted by the Bidder shall include all Materials, Tools & Plant, labour, supervision, profit; other levies together with all general risks, liabilities and obligations set out or implied in the contract, applicable Labour Cess, cost of insurance to this contract, all applicable tax liabilities like Income Tax & Surcharges, etc. Any other taxes /cess as per Government directives shall be deducted from each bill paid to the Contractor, from time to time. GST shall be payable extra as per prevailing rates. It is mandatory to bidders to deposit GST within time limit framed by Govt. of India, if applicable. The Goods and Services Tax (GST), shall be reimbursed to the Agency only after uploading of bills by Contractor on GST Portal “ to avail Input benefit of GST
- The Contractor shall issue Tax Invoices to the Employer showing (i) Basic amount (ii) GST amount separately in each bill. It is mandatory to bidders to deposit GST within time limit framed by Govt. of India, if applicable. The Goods and Services Tax (GST), shall be reimbursed to the Agency only after uploading of bills by Contractor on GST Portal “to avail Input benefit of GST”.
- The company shall be performing all its duties of deduction TDS and other deduction on payment made to the contractor as per applicable legislation in force on the date of submission of bid or to be newly / amended introduced during the execution of the Contract.

Detailed Bill of Quantities

**Name of Work:- Construction of Eklavya Model Residential School (EMRS),
AT JALDEGA, SIMDEGA, JHARKHAND**

**ABSTRACT OF COST
SUMMARY SHEET**

| S.No | PARTICULARS | AMOUNT (IN RS) | |
|---|--|------------------------|---------------------|
| | | DSR | NON DSR |
| CIVIL WORKS | | | |
| 1 | Earth Work | 77,99,727.90 | |
| 2 | Concrete Work | 1,01,68,766.16 | |
| 3 | Reinforced Cement Concrete | 13,88,51,051.03 | |
| 4 | Masonry Work | 3,07,12,994.65 | |
| 5 | Stone Work | 6,98,496.15 | |
| 6 | Cladding Work | 44,89,758.35 | |
| 7 | Wood & PVC Work | 38,59,434.35 | |
| 8 | Steel Work | 1,43,89,241.85 | |
| 9 | Flooring | 1,72,51,641.80 | |
| 10 | Roofing | 3,12,201.10 | |
| 11 | Finishing | 2,61,57,288.45 | |
| 12 | Aluminium Work | 3,45,622.15 | |
| 13 | Water Proofing | 84,49,573.30 | |
| 14 | Road Work | 82,20,430.27 | |
| 15 | Non-Schedule Items | | 37,56,555.00 |
| TOTAL OF CIVIL WORKS (DSR) | | 27,17,06,227.51 | |
| TOTAL OF CIVIL WORKS (NON DSR) | | | 37,56,555.00 |
| TOTAL (CIVIL WORKS) | | | 275462782.51 |
| PLUMBING WORKS | | | |
| 16 | Sanitary Installations | 24,63,629.47 | 4,71,582.73 |
| 17 | Drainage Installations | 2,23,285.30 | 11,35,822.25 |
| 18 | Water supply Installations | 21,18,141.65 | 75,329.75 |
| 19 | External Sewage Drainage System | 35,59,548.45 | |
| 20 | External Storm Water Drainage System | 15,29,605.70 | |
| 21 | External Fresh Water Supply System | 11,60,457.60 | |
| 22 | Bore well | 1,50,156.40 | |
| TOTAL OF PLUMBING WORKS (DSR) | | 1,12,04,824.56 | |
| TOTAL OF PLUMBING WORKS (NON DSR) | | | 16,82,734.73 |
| TOTAL (PLUMBING WORKS) | | | 12887559.29 |
| FIRE FIGHTING WORKS | | | |
| 23 | Piping & Valves | 4,88,819.30 | 2,046.00 |
| 24 | Fire Hydrant Accessories | 1,85,086.00 | |
| 25 | Fire Extinguishers & Miscellaneous Items | | 1,23,942.00 |
| 26 | Fire Pumps & Accessories | 3,09,900.00 | 1,04,967.00 |
| TOTAL OF FIRE FIGHTING WORKS (DSR) | | 9,83,805.30 | |
| TOTAL OF FIRE FIGHTING WORKS (NON DSR) | | | 2,30,955.00 |
| TOTAL (FIRE FIGHTING WORKS) | | | 1214760.30 |
| ELECTRICAL WORKS (Internal) | | | |
| 27 | Internal Wiring | 59,89,084.00 | 37,387.00 |
| 28 | Distribution Boards & MCB's | 6,84,133.00 | 19,175.00 |
| 29 | Telephone, Television & Data System (socket,wiring & conducting only) | 5,09,972.00 | 16,800.00 |
| 30 | Light Fixtures & Fan | 5,57,211.00 | 20,15,244.00 |
| TOTAL OF ELECTRICAL WORKS INTERNAL (DSR) | | 77,40,400.00 | |
| TOTAL OF ELECTRICAL WORKS INTERNAL (NON DSR) | | | 20,88,606.00 |
| TOTAL (ELECTRICAL WORKS INTERNAL) | | | 9829006.00 |
| ELECTRICAL WORKS (External) | | | |
| 31 | Transformer and HT Panel | | 11,80,113.00 |
| 32 | LT Panel, Feeder Pillar and Capacitor Panels | | 15,11,553.00 |
| 33 | LT Cables | 15,86,800.00 | 25,11,010.00 |

| S.No | PARTICULARS | AMOUNT (IN RS) | |
|---|--|-----------------------|---------------------|
| | | DSR | NON DSR |
| 34 | HT Cables | 91,177.00 | 2,00,520.00 |
| 35 | Miscellaneous | 7,765.00 | 20,063.00 |
| 36 | Earthing | 3,82,700.00 | |
| 37 | Pole Erection | 3,66,204.00 | |
| 38 | External Lighting System | 4,54,010.00 | 17,04,184.00 |
| 39 | UPS - 10 kVA | | 2,25,122.00 |
| 40 | Lightning Arrestor System for Transformer | | 12,021.00 |
| 41 | Pumps | | 2,68,190.00 |
| 42 | CCTV System | 1,55,470.00 | 5,68,628.00 |
| 43 | Lightning Conductor | 4,05,904.00 | |
| 45 | 62.5 KVA DG Set and associated works | | 7,28,820.00 |
| TOTAL OF ELECTRICAL WORKS EXTERNAL | | 34,50,030.00 | |
| TOTAL OF ELECTRICAL WORKS EXTERNAL | | | 89,30,224.00 |
| TOTAL (ELECTRICAL WORKS EXTERNAL) | | | 12380254.00 |
| Add enhancement @5% over DSR 2019, Due to increase in Cost Index | | 1,47,54,264.37 | |
| X | Total Cost Including 12% GST | | 32,65,28,626 |
| Y | Total Cost Including 18% GST (Multiplying factor of 1.0633 on X) as per CPWD circular dt. 10-08-2022 | | 34,71,97,889 |
| Z | Total Cost Excluding 18% GST (Y/1.18) | | 29,42,35,499 |

IMPORTANT NOTE:

The Calculation of running bills of the Constructor, will be done as per above manner after execution of works against each running bill, to achieve value of "X,Y&Z".

The addition/deductions as per the Percentage Quoted by the Contractor/will be applied on the value which will come on "Z" as per above.

The applicable GST will be paid on "Z".

SCHEDULE OF QUANTITIES

**Name of Work:- Construction of Eklavya Model Residential School (EMRS),
AT JALDEGA, SIMDEGA, JHARKHAND
ESTIMATE**

| S. No. | DSR 2019 | Description | Unit | Quantity | Rate (In Rs) | Amount (In Rs) |
|---------|----------|--|------|----------|--------------|----------------|
| | | CIVIL WORKS | | | | |
| 1.0 | 2 | Earth Work | | | | |
| 0.01 | 2.1 | Earth work in surface excavation not exceeding 30 cm in depth but exceeding 1.5 m in width as well as 10 sqm on plan including getting out and disposal of excavated earth upto 50 m and lift upto 1.5 m, as directed by Engineer-in- Charge: | | | | |
| 1.01.1 | 2.1.1 | All kinds of soil | Cum | 1810 | 92.55 | 1,67,506.25 |
| 1.01 | 2.6 | Earth work in excavation by mechanical means (Hydraulic excavator)/manual means over areas (exceeding 30 cm in depth, 1.5 m in width as well as 10 sqm on plan) including getting out and disposal of excavated earth lead upto 50m and lift upto 1.5m, as directed by Engineer-in-charge. | | | | |
| 1.01.1 | 2.6.1 | All kinds of soil | Cum | 11488 | 181.85 | 20,89,092.80 |
| 1.02 | 2.7 | Earth work in excavation by mechanical means (Hydraulic excavator)/manual means over areas (exceeding 30 cm in depth, 1.5 m in width as well as 10 sqm on plan) including getting out and disposal of excavated earth lead upto 50m and lift upto 1.5m, as directed by Engineer-in-charge. | | | | |
| 1.02.1 | 2.7.1 | Ordinary Rock | Cum | 1110 | 352.45 | 3,91,219.50 |
| 1.02.02 | 2.7.3 | Hard rock (blasting prohibited) | Cum | 123 | 1016.20 | 1,24,992.60 |
| 1.03 | 2.8 | Earth work in excavation by mechanical means (Hydraulic excavator) / manual means in foundation trenches or drains (not exceeding 1.5 m in width or 10 sqm on plan), including dressing of sides and ramming of bottoms, lift upto 1.5m, including getting out the excavated soil and disposal of surplus excavated soil as directed within a lead of 50m. | | | | |
| 1.03.1 | 2.8.1 | All kinds of soil. | Cum | 3531 | 252.30 | 8,90,770.38 |
| 1.04 | 2.9 | Excavation work by mechanical means (Hydraulic excavator)/ manual means in foundation trenches or drains (not exceeding 1.5m in width or 10 sqm on plan), including dressing of sides and ramming of bottoms, lift upto 1.5m, including getting out the excavated soil and disposal of surplus excavated soils as directed within a lead of 50m. | | | | |
| 1.04.01 | 2.9.1 | Ordinary Rock | Cum | 234 | 448.15 | 1,04,867.10 |
| 1.04.02 | 2.9.3 | Hard rock (blasting prohibited) | Cum | 123 | 1080.55 | 1,32,907.65 |
| 1.05 | 2.25 | Filling available excavated earth (excluding rock) in trenches, plinth, sides of foundations etc. in layers not exceeding 20cm in depth, consolidating each deposited layer by ramming and watering lead upto 50m and lift upto 1.50m. | Cum | 11829 | 219.65 | 25,98,239.85 |

Signature of Bidder

| S. No. | DSR 2019 | Description | Unit | Quantity | Rate (In Rs) | Amount (In Rs) |
|---------|--------------------------------------|---|------|----------|-------------------|---------------------|
| 1.06 | 2.26 | Extra for every additional lift of 1.5 m or part thereof in excavation / banking excavated or stacked materials. | | | | |
| 1.06.01 | 2.26.1 | All kinds of soil | Cum | 688 | 90.40 | 62,195.20 |
| 1.07 | 2.27 | Supplying and filling in plinth with sand under floors, including watering, ramming, consolidating and dressing complete. | Cum | 505 | 1953.05 | 9,86,290.25 |
| 1.08 | 2.31 | Clearing jungle including uprooting of rank vegetation, grass, brush wood, trees and saplings of girth up to 30 cm measured at a height of 1 m above ground level and removal of rubbish upto a distance of 50m outside the periphery of the area cleared. | Sqm | 20052 | 12.55 | 2,51,646.33 |
| | | Total of sub-head (1.0) | | | 7799727.90 | 77,99,727.90 |
| 2.0 | 4 | Concrete Work | | | | |
| 2.01 | 4.1 | Providing and laying in position cement concrete of specified grade excluding the cost of centering and shuttering - All work up to plinth level : | | | | |
| 2.01.1 | 4.1.8 | 1:4:8 (1 Cement : 4 coarse sand (zone-III) derived from natural sources : 8 graded stone aggregate 40 mm nominal size derived from natural sources) | Cum | 29 | 5789.60 | 1,67,898.40 |
| 2.01.2 | 4.1.10 | 1:5:10 (1 cement : 5 coarse sand (zone-III) derived from natural sources: 10 graded stone aggregate 40 mm nominal size derived from natural sources) | Cum | 1220 | 5520.30 | 67,35,318.03 |
| 2.01.2 | 4.1.3 | 1:2:4 (1 Cement : 2 coarse sand (zone-III) : 4 graded stone aggregate 40 mm nominal size) | Cum | 130 | 6788.60 | 8,81,072.03 |
| 2.02 | Derived from basic rates of DSR 2019 | Providing and laying broken autoclaved aerated cement (AAC) blocks and/or bats (light weight, having density 550-650 kg/m ³) of nominal size 25mm to 65mm in the sunken portion of toilets upto floor five level all complete as per the direction of Engineer-in-charge. | Cum | 142 | 2345.10 | 3,33,004.20 |
| 2.03 | 4.2 | Providing and laying cement concrete in retaining walls, return walls, walls (any thickness) including attached pilasters, columns, piers, abutments, pillars, posts, struts, buttresses, string or lacing courses, parapets, coping, bed blocks, anchor blocks, plain window sills, fillets, sunken floor etc., up to floor five level, excluding the cost of centering, shuttering and finishing: | | | | |
| 2.03.1 | 4.2.3 | 1:2:4 (1 Cement : 2 coarse sand (zone-III) derived from natural sources : 4 graded stone aggregate 20 mm nominal size derived from natural sources) | Cum | 86 | 8554.50 | 7,35,687.00 |
| 2.04 | 4.3 | Centering and shuttering including strutting, propping etc. and removal of form work for : | | | | |
| 2.03.1 | 4.3.1 | Foundations, footings, bases for columns | Sqm | 1029 | 284.85 | 2,93,144.60 |

| S. No. | DSR 2019 | Description | Unit | Quantity | Rate (In Rs) | Amount (In Rs) |
|---------|----------|---|-------|----------|--------------------|-----------------------|
| 2.05 | 4.10 | Providing and laying damp-proof course 40mm thick with cement concrete 1:2:4 (1 cement : 2 coarse sand (zone-III) derived from natural sources: 4 graded stone aggregate 12.5mm nominal size derived from natural sources) | Sqm | 738 | 347.90 | 2,56,750.20 |
| 2.06 | 4.13 | Providing & applying a coat of residual petroleum bitumen of grade of VG-10 of approved quality using 1.7kg per square metre on damp proof course after cleaning the surface with brushes and finally with a piece of cloth lightly soaked in kerosene oil. | Sqm | 744 | 110.00 | 81,840.00 |
| 2.07 | 4.17 | Making plinth protection 50mm thick of cement concrete 1:3:6 (1 cement : 3 coarse sand (zone-III) derived from natural sources : 6 graded stone aggregate 20 mm nominal size derived from natural sources) over 75mm thick bed of dry brick ballast 40 mm nominal size, well rammed and consolidated and grouted with fine sand, including necessary excavation, levelling & dressing & finishing the top smooth. | Sqm | 1114 | 614.05 | 6,84,051.70 |
| | | Total of sub-head (2.0) | | | 10168766.16 | 1,01,68,766.16 |
| 3.0 | 5 | Reinforced Cement Concrete | | | | |
| 3.01 | 5.9 | Centering and shuttering including strutting, propping etc. and removal of form for : | | | | |
| 3.01.1 | 5.9.1 | Foundations, footings, bases of columns, etc. for mass concrete | Sqm | 3010 | 284.85 | 8,57,398.50 |
| 3.01.2 | 5.9.2 | Walls (any thickness) including attached pilasters, buttresses, plinth and string courses etc. | Sqm | 1901 | 609.30 | 11,58,279.30 |
| 3.01.3 | 5.9.3 | Suspended floors, roofs, landings, balconies and access platform | Sqm | 10169 | 693.05 | 70,47,625.45 |
| 3.01.4 | 5.9.4 | Shelves (Cast in situ) | Sqm | 1158 | 693.05 | 8,02,551.90 |
| 3.01.5 | 5.9.5 | Lintels, beams, plinth beams, girders, bressumers and cantilevers | Sqm | 11396 | 552.05 | 62,91,151.86 |
| 3.01.6 | 5.9.6 | Columns, Pillars, Piers, Abutments, Posts and Struts | Sqm | 9245 | 733.07 | 67,77,232.15 |
| 3.01.7 | 5.9.7 | Stairs, (excluding landings) except spiral-staircases | Sqm | 220 | 622.35 | 1,36,917.00 |
| 3.01.7A | 5.9.14 | Extra for shuttering in circular work(20% of respective centering and shuttering items) | Sqm | 474 | 146.61 | 69,493.14 |
| 3.01.8 | 5.9.15 | Small lintels not exceeding 1.5 m clear span, moulding as in cornices, window sills, string courses, bands, copings, bed plates, anchor blocks and the like | Sqm | 28 | 284.85 | 7,975.80 |
| 3.01.9 | 5.9.16 | Edges of slabs and breaks in floors and walls | | | | |
| | 5.9.16.1 | Under 20 cms wide | Metre | 580 | 173.25 | 1,00,485.00 |
| 3.01.10 | 5.9.19 | Weather shade, Chajjas, corbels etc., including edges | Sqm | 1154 | 766.75 | 8,84,829.50 |
| 3.01.11 | 5.11 | Extra for additional height in centering, shuttering where ever required with adequate bracing, propping etc., including cost of de-shuttering and decentering at all levels, over a height of 3.5 m, for every additional height of 1 metre or part thereof (Plan area to be measured). | | | | |

| S. No. | DSR 2019 | Description | Unit | Quantity | Rate (In Rs) | Amount (In Rs) |
|---------|-------------------|--|---------|----------|--------------|----------------|
| | 5.11.1 | Suspended floors, roofs, landing, beams and balconies (Plan area to be measured) | Sqm | 3234 | 287.50 | 9,29,775.00 |
| 3.01.12 | 5.22 | Steel reinforcement for R.C.C. work including straightening, cutting, bending, placing in position and binding all complete upto plinth level. | | | | |
| | 5.22.6 | Thermo-Mechanically Treated bars of grade Fe-500D or more. | kg | 224540 | 83.50 | 1,87,49,090.00 |
| 3.01.13 | 5.22A | Steel reinforcement for R.C.C. work including straightening, cutting, bending, placing in position and binding all complete above plinth level. | | | | |
| | 5.22A.5 | Hard drawn steel wire fabric | Kg | | 92.15 | - |
| | 5.22A.6 | Thermo-Mechanically Treated bars of grade Fe-500D or more. | kg | 499473 | 83.50 | 4,17,05,995.50 |
| 3.01.14 | 5.30 | Add for plaster drip course/ groove in plastered surface or moulding to R.C.C. projections. | Metre | 1057 | 58.90 | 62,257.30 |
| 3.01.15 | 5.33 | Providing and laying in position machine batched and machine mixed design mix M-25 grade cement concrete for reinforced cement concrete work, using cement content as per approved design mix, including pumping of concrete to site of laying but excluding the cost of centering, shuttering, finishing and reinforcement, including admixtures in recommended proportions as per IS: 9103 to accelerate, retard setting of concrete, improve workability without impairing strength and durability as per direction of Engineer-in-charge. (Note :- Cement content considered in this item is @ 330 kg/cum. Excess/ less cement used as per design mix is payable/recoverable separately). | | | | |
| | 5.33.1 | All works upto plinth level | Cum | 2490 | 7997.30 | 1,99,13,470.98 |
| | 5.33.2 | All works above plinth level upto floor V level. | Cum | 3348 | 9400.85 | 3,14,74,045.80 |
| 3.01.16 | 5.34 | Extra for providing richer mixes at all floor levels. Note:- Excess/less cement over the specified cement content used is payable /recoverable separately. | | | | |
| | 5.34.1 | Providing M-30 grade concrete instead of M-25 grade BMC/ RMC. (Note:- Cement content considered in M-30 is @ 340 kg/cum) | Cum | 321 | 69.75 | 22,389.75 |
| 0.01 | 5.34.1 (Modified) | Deduct for providing M-20 grade concrete instead of M-25 grade machine batched and machine mixed design mix for reinforced cement concrete work (Note:- Cement content considered in M-25 and M-20 is @ 330 kg/cum and 300 kg/cum respectively) (this item is applicable for RCC in grade slab only) | Cum | 331 | -230.90 | (76,427.90) |
| 3.01.17 | 5.35 | Add for using extra cement in the items of design mix over and above the specified cement content therein. | quintal | 1900 | 673.30 | 12,79,113.80 |
| 3.01.18 | 5.43 | Providing and fixing in position Stainless steel Grade 304 plate-1.0 mm thick as per design for expansion joints. | | | | |
| | 5.43.1 | 200 mm wide. | Metre | 49 | 711.90 | 34,883.10 |

| S. No. | DSR 2019 | Description | Unit | Quantity | Rate (In Rs) | Amount (In Rs) |
|---------|--------------------|---|-------|----------|--------------|----------------|
| 3.01.19 | 5.44 (Modified) | Providing and fixing of expansion joint system related with floor location as per drawings and direction of Engineer-In-Charge. The joints system will be of extruded aluminum base members, self aligning / self centering arrangement and support plates etc. as per ASTM B221-02. The system shall be such that it provides floor to floor /floor to wall expansion control system for various vertical location in load application areas that accommodates multi directional seismic movement without stress to it's components. System shall consist of metal profiles with a universal aluminum base member designed to accommodate various project conditions and finish floor treatments. | | | | |
| | | The cover plate shall be designed of width and thickness required to satisfy projects movement and loading requirements and secured to base members by utilizing manufacturer's pre-engineered self- centering arrangement that freely rotates / moves in all directions. The Self - centering arrangement shall exhibit circular sphere ends that lock and slide inside the corresponding aluminum extrusion cavity to allow freedom of movement and flexure in all directions including vertical displacement. Provision of Moisture Barrier Membrane in the Joint System to have watertight joint is mandatory requirement all as per the manufactures design and as approved by Engineer -in-Charge. (Material shall confirm to ASTM 6063). | | | | |
| | 5.44.1 | Floor Joint of 50 mm gap | Metre | 49 | 4390.70 | 2,15,144.30 |
| 3.01.20 | 5.45 (Modified) | Providing and fixing of expansion joint system related with wall joint (internal/ external) location as per drawings and direction of Engineer-In- Charge. The joints shall be of extruded aluminum base members, self aligning / centering arrangement and support plates as per ASTM B221- 02. The material shall be such that it provides an Expansion Joints System suitable for vertical wall to wall/ wall to corner application, both new and existing construction in office Buildings & complexes with no slipping down tendency amongst the components of the Joint System. The Joint System shall utilize light weight aluminum profiles exhibiting minimal exposed aluminum surfaces mechanically snap locking the multicellular to facilitate movement. (Material shall confirm to ASTM 6063.) | | | | |
| | 5.45.1 | Wall Joint of 50 mm gap | Metre | 79 | 4123.10 | 3,25,724.90 |

| S. No. | DSR 2019 | Description | Unit | Quantity | Rate (In Rs) | Amount (In Rs) |
|---------|--------------------|---|-------|------------------|--------------|------------------------|
| 3.01.21 | 5.46 (Modified) | Providing and fixing of expansion joint system of approved make and manufactures for various roof locations as per approved drawings and direction of Engineer-In-Charge. The joints shall be of extruded aluminum base members with, self aligning and self centering arrangement support plates as per ASTM B221-02. The system shall be such that it provides watertight roof to roof/roof to corner joint cover expansion control system that is capable of accommodating multidirectional seismic movement without stress to its components. System shall consist of metal profile that incorporates a universal aluminum base member designed to accommodate various project conditions and roof treatments. | | | | |
| | | The cover plate shall be designed of width and thickness required to satisfy movement and loading requirements and secured to base members by utilizing manufacturer's preengineered self-centering arrangement that freely rotates / moves in all directions. The Self centering arrangement shall exhibit circular sphere ends that lock and slide inside the corresponding aluminum extrusion cavity to allow freedom of movement and flexure in all directions including vertical displacement. The Joint System shall resist damage or deterioration from the impact of falling ice, exposure to UV, airborne contaminants and occasional foot traffic from maintenance personnel. Provision of Moisture Barrier Membrane in the Joint System to have water tight joint is mandatory requirement. (Material shall conform to ASTM 6063). | | | | |
| | 5.46.1 | Roof Joint of 50 mm gap | Metre | 17 | 4658.30 | 79,191.10 |
| 3.01.22 | 19.19 | Providing and fixing in position pre-cast R.C.C. manhole cover and frame of required shape and approved quality | | | | |
| | 19.19.1 | LD-2.5 | | | | |
| | 19.19.1.1 | Rectangular shape 600x450mm internal dimensions | Each | 2 | 1228.90 | 2,457.80 |
| 3.01.23 | 19.32 | Making soak pit 2.5 m diameter 3.0 metre deep with 45 x 45 cm dry brick honey comb shaft with bricks and S.W. drain pipe 100 mm diameter, 1.8 m long complete as per standard design. | | | | |
| | 19.32.1 | With common burnt clay F.P.S. (non modular) bricks of class designation 7.5 | Each | | 25278.75 | - |
| | | Total of sub-head (3.0) | | 138851051 | | 13,88,51,051.03 |
| 4.0 | 6 | Masonry Work | | | | |
| 4.01 | 6.1 | Brick work with common burnt clay F.P.S. (non modular) bricks of class designation 7.5 in foundation and plinth in: | | | | |
| | 6.1.2 | Cement mortar 1:6 (1 cement : 6 coarse sand) | Cum | 715 | 6157.45 | 44,02,576.75 |

| S. No. | DSR 2019 | Description | Unit | Quantity | Rate (In Rs) | Amount (In Rs) |
|--------|-------------------|--|------|--------------------|--------------|-----------------------|
| 4.02 | 6.1 (Modified) | Brick work with non modular fly ash bricks conforming to IS:12894, class designation 10 average compressive strength in foundation and plinth in: | | | | |
| | 6.1.2 | Cement mortar 1:6 (1 cement : 6 coarse sand) | Cum | | 6025.25 | - |
| 4.03 | 6.4 | Brick work with common burnt clay F.P.S. (non modular) bricks of class designation 7.5 in superstructure above plinth level up to floor V level in all shapes and sizes in : | | | | |
| | 6.4.2 | Cement mortar 1:6 (1 cement : 6 coarse sand) | Cum | 96 | 7590.45 | 7,28,683.20 |
| 4.04 | 6.34 | Brick work with non modular fly ash bricks conforming to IS:12894, class designation 10 average compressive strength in super structure above plinth level up to floor V level in : | | | | |
| | 6.34.2 | Cement mortar 1:6 (1 cement : 6 coarse sand) | Cum | 2846 | 7280.70 | 2,07,20,872.20 |
| 4.05 | 6.45 | Half brick masonry with non modular fly ash bricks of class designation 10, conforming IS :12894, in super structure above plinth and upto floor V level. | | | | |
| | 6.45.2 | Cement mortar 1:4 (1 cement :4 coarse sand) | Sqm | 4875 | 917.00 | 44,70,375.00 |
| 4.06 | 6.15 | Extra for providing and placing in position 2 Nos 6mm dia. M.S. bars at every third course of half brick masonry. | Sqm | 4875 | 80.10 | 3,90,487.50 |
| | | Total of sub-head (4.0) | | 30712994.65 | | 3,07,12,994.65 |
| 5.0 | | Stone Work | | | | |
| 5.01 | 7.1 | Random rubble masonry with hard stone in foundation and plinth including levelling up with cement concrete 1:6:12 (1 cement : 6 coarse sand : 12 graded stone aggregate 20 mm nominal size) upto plinth level with : | | | | |
| | 7.1.1 | Cement mortar 1:6 (1 cement : 6 coarse sand) | Cum | 108 | 6120.80 | 6,61,046.40 |
| 5.02 | 7.2 | Random rubble masonry with hard stone in superstructure above plinth level and upto floor five level, including leveling up with cement concrete 1:6:12 (1 cement : 6 coarse sand : 12 graded stone aggregate 20 mm nominal size) at sindow sills, ceiling level and the like. | | | | |
| | 7.2.1 | Cement mortar 1:6 (1 cement : 6 coarse sand) | Cum | 5 | 7489.95 | 37,449.75 |
| | | Total of sub-head (5.0) | | 698496.15 | | 6,98,496.15 |
| 6.0 | 8 | Cladding Work | | | | |

| S. No. | DSR 2019 | Description | Unit | Quantity | Rate (In Rs) | Amount (In Rs) |
|--------|----------|--|-------|-------------------|--------------|---------------------|
| 6.01 | 8.2 | Providing and fixing 18 mm thick gang saw cut, mirror polished, premoulded and prepolished, machine cut for kitchen platforms, vanity counters, window sills, facias and similar locations of required size, approved shade, colour and texture laid over 20 mm thick base cement mortar 1:4 (1 cement : 4 coarse sand), joints treated with white cement, mixed with matching pigment, epoxy touch ups, including rubbing, curing, moulding and polishing to edges to give high gloss finish etc. complete at all levels. | | | | |
| | 8.2.2 | Granite of any colour and shade | | | | |
| 6.01.1 | 8.2.2.1 | Area of slab upto 0.50 sqm | Sqm | 29 | 4217.35 | 1,22,303.15 |
| 6.01.2 | 8.2.2.2 | Area of slab over 0.50 sqm | Sqm | 212 | 4007.65 | 8,49,621.80 |
| | | | | | | |
| 6.02 | 8.4 | Extra for fixing marble /granite stone, over and above corresponding basic item, in facia and drops of width upto 150 mm with epoxy resin based adhesive, including cleaning etc. complete. | Metre | 221 | 434.25 | 95,969.25 |
| | | | | | | |
| 6.03 | 8.5 | Extra for providing opening of required size & shape for wash basin/ kitchen sink in kitchen platform, vanity counter and similar location in marble/ Granite/ stone work, including necessary holes for pillar taps etc. including moulding, rubbing and polishing of cut edges etc. complete. | Each | 41 | 734.55 | 30,116.55 |
| | | | | | | |
| 6.04 | 8.31 | Providing and fixing 1st quality ceramic glazed wall tiles conforming to IS: 15622 (thickness to be specified by the manufacturer), of approved make, in all colours, shades except burgundy, bottle green, black of any size as approved by Engineer-in-Charge, in skirting, risers of steps and dados, over 12 mm thick bed of cement mortar 1:3 (1 cement : 3 coarse sand) and jointing with grey cement slurry @ 3.3kg per sqm, including pointing in white cement mixed with pigment of matching shade complete. | Sqm | 3292 | 1030.30 | 33,91,747.60 |
| | | | | | | |
| | | Total of sub-head (6.0) | | 4489758.35 | | 44,89,758.35 |
| | | | | | | |
| 7.0 | 9 | Wood Work & PVC Work | | | | |
| 7.01 | 9.12 | Extra for providing frosted glass panes 4 mm thick instead of ordinary float glass panes 4 mm thick in doors, windows and clerestory window shutters. (Area of opening for glass panes excluding portion inside rebate shall be measured). | Sqm | 104 | 214.05 | 22,261.20 |
| | | | | | | |
| 7.02 | 9.21 | Providing and fixing ISI marked flush door shutters conforming to IS : 2202 (Part I) non-decorative type, core of block board construction with frame of 1st class hard wood and well matched commercial 3 ply veneering with vertical grains or cross bands and face veneers on both faces of shutters: | | | | |

| S. No. | DSR 2019 | Description | Unit | Quantity | Rate (In Rs) | Amount (In Rs) |
|--------|----------|---|-------|----------|--------------|----------------|
| | 9.21.1 | 35 mm thick including ISI marked Stainless Steel butt hinges with necessary screws | Sqm | 526 | 1886.70 | 9,92,404.20 |
| 7.03 | 9.23 | Extra for providing lipping with 2nd class teak wood battens 25 mm minimum depth on all edges of flush door shutters (over all area of door shutter to be measured). | Sqm | 527 | 401.40 | 2,11,537.80 |
| 7.04 | 9.26 | Extra for cutting rebate in flush door shutters (Total area of the shutter to be measured). | Sqm | 7 | 93.65 | 655.55 |
| 7.05 | 9.47 | Providing and fixing nickel plated M.S. pipe curtain rods with nickel plated brackets : | | | | |
| | 9.47.2 | 25 mm dia (heavy type) | Metre | 1103 | 162.35 | 1,79,072.05 |
| 7.06 | 9.48 | Providing and fixing M.S. grills of required pattern in frames of windows etc. with M.S. flats, square or round bars etc. including priming coat with approved steel primer all complete | | | | |
| | 9.48.1 | Fixed to steel windows by welding | kg | 9345 | 165.30 | 15,44,728.50 |
| 7.07 | 9.24 | Extra for providing vision panel not exceeding 0.1 sqm in all type of flush doors (cost of glass excluded) (overall area of door shutter to be measured): | | | | |
| | 9.24.1 | Rectangular or square | Sqm | 401 | 173.95 | 69,753.95 |
| 7.08 | 9.55 | Deduction for not providing and fixing ISI marked M.S. pressed butt hinges bright finished with necessary screws etc. complete : | | | | |
| | 9.55.2 | 100x58x1.90 mm | Each | 1917 | 37.30 | 71,504.10 |
| 7.09 | 9.96 | Providing and fixing aluminium sliding door bolts, ISI marked anodised (anodic coating not less than grade AC 10 as per IS : 1868), transparent or dyed to required colour or shade, with nuts and screws etc. complete : | | | | |
| | 9.96.1 | 300x16 mm | Each | 4 | 257.15 | 1,028.60 |
| | 9.96.2 | 250x16 mm | Each | 417 | 231.70 | 96,618.90 |
| 7.1 | 9.68 | Providing and fixing oxidised M.S. casement stays (straight peg type) with necessary screws etc. complete. | | | | |
| | 9.68.1 | 300 mm weighing not less than 200 gms | Each | 2934 | 58.80 | 1,72,519.20 |
| 7.11 | 9.84 | Providing and fixing aluminium extruded section body tubular type universal hydraulic door closer (having brand logo with ISI, IS : 3564, embossed on the body, door weight upto 36 kg to 80 kg and door width from 701 mm to 1000 mm), with double speed adjustment with necessary accessories and screws etc. complete. | Each | 62 | 851.60 | 52,799.20 |
| 0.01 | 9.85 | Providing and fixing bright finished brass casement window fastener with necessary screws etc. complete. | Each | 2130 | 75.70 | 1,61,241.00 |

| S. No. | DSR 2019 | Description | Unit | Quantity | Rate (In Rs) | Amount (In Rs) |
|--------|-----------|---|------|-------------------|--------------|---------------------|
| 7.12 | 9.97 | Providing and fixing aluminium tower bolts, ISI marked, anodised (anodic coating not less than grade AC 10 as per IS : 1868) transparent or dyed to required colour or shade, with necessary screws etc. complete : | | | | |
| | 9.97.1 | 300x10 mm | Each | 429 | 116.80 | 50,107.20 |
| | 9.97.4 | 150x10 mm | Each | 429 | 75.00 | 32,175.00 |
| 7.13 | 9.100 | Providing and fixing aluminium handles, ISI marked, anodised (anodic coating not less than grade AC 10 as per IS : 1868) transparent or dyed to required colour or shade, with necessary screws etc. complete : | | | | |
| | 9.100.1 | 125 mm | Each | 882 | 59.65 | 52,611.30 |
| | 9.100.2 | 100 mm | Each | 4 | 52.85 | 211.40 |
| 7.14 | 9.101 | Providing and fixing aluminium hanging floor door stopper, ISI marked, anodised (anodic coating not less than grade AC 10 as per IS : 1868) transparent or dyed to required colour and shade, with necessary screws etc. complete. | | | | |
| | 9.101.2 | Twin rubber stopper | Each | 334 | 62.05 | 20,724.70 |
| 7.15 | A | Providing and fixing frame work for partitions/ wall lining etc. made of 50x50x1.6 mm hollow MS tube, placed along the walls, ceiling and floor in a grid pattern with spacing @ 60 cm centre to centre both ways (vertically & horizontally) or at required spacing near opening, with necessary welding at junctions and fixing the frame to wall/ ceiling/ floors with steel dash fasteners of 8 mm dia, 75 mm long bolt, including making provision for opening for doors, windows, electrical conduits, switch boards etc., including providing with two coats of approved steel primer etc. complete, all as per direction of Engineer-in-charge. | Kg | 1026 | 124.25 | 1,27,480.50 |
| | | Total of sub-head (7.0) | | 3859434.35 | | 38,59,434.35 |
| 8.0 | 10 | Steel Work | | | | |
| 8.01 | 10.3 | Providing and fixing in position collapsible steel shutters with vertical channels 20x10x2 mm and braced with flat iron diagonals 20x5 mm size, with top and bottom rail of T-iron 40x40x6 mm, with 40 mm dia steel pulleys, complete with bolts, nuts, locking arrangement, stoppers, handles, including applying a priming coat of approved steel primer. | Sqm | 66 | 8670.50 | 5,72,253.00 |
| 8.02 | 10.6 | Supplying and fixing rolling shutters of approved make, made of required size M.S. laths, interlocked together through their entire length and jointed together at the end by end locks, mounted on specially designed pipe shaft with brackets, side guides and arrangements for inside and outside locking with push and pull operation complete, including the cost of providing and fixing necessary 27.5 cm long wire springs manufactured from high tensile steel wire of adequate strength conforming to IS: 4454 - part 1 and M.S. top cover of required thickness for rolling shutters. | | | | |

| S. No. | DSR 2019 | Description | Unit | Quantity | Rate (In Rs) | Amount (In Rs) |
|--------|------------------|---|-------|----------|--------------|----------------|
| | 10.6.1 | 80x1.25 mm M.S. laths with 1.25 mm thick top cover | Sqm | 27 | 2944.10 | 79,490.70 |
| 8.03 | 10.7 | Providing and fixing ball bearing for rolling shutters. | Each | 3 | 419.85 | 1,259.55 |
| 8.04 | 10.8 | Extra for providing mechanical device chain and crank operation for operating rolling shutters | | | | |
| | 10.8.1 | Exceeding 10.00 sqm and upto 16.80 sqm in the area | Sqm | 15 | 1106.55 | 16,598.25 |
| 8.05 | 10.11 | Providing and fixing factory made ISI marked steel glazed doors, windows and ventilators, side /top /centre hung, with beading and all members such as F7D,F4B, K11 B and K12 B etc. complete of standard rolled steel sections, joints mitred and flash butt welded and sash bars tenoned and riveted, including providing and fixing of hinges, pivots, including priming coat of approved steel primer, but excluding the cost of other fittings, complete all as per approved design, (sectional weight of only steel members shall be measured for payment). | | | | |
| | 10.11.1 | Fixing with 15x3 mm lugs 10 cm long embedded in cement concrete block 15x10x10 cm of C.C. 1:3:6 (1 Cement : 3 coarse sand : 6 graded stone aggregate 20 mm nominal size) | kg | 23878 | 166.50 | 39,75,675.35 |
| | 10.11 (Modified) | Deduct for omitting cement concrete block 15x10x10 cm of C.C. 1:3:6 (1 Cement : 3 coarse sand : 6 graded stone aggregate 20 mm nominal size) in fixing standard steel glazed doors, windows and ventilators in walls. (Rate is below item no. 10.11.1) | kg | 23878 | -63.00 | (15,04,314.00) |
| | 10.12 (Modified) | Providing and fixing steel beading of size 10 x 10 x 1.6 mm (box type), approved shape and section with screws in steel doors, windows, ventilators, composite units and M.S. tubular frame etc. | Metre | 927 | 45.40 | 42,085.80 |
| 8.06 | 10.13 | Providing and fixing T-iron frames for doors of mild steel Tee-sections, joints mitred and welded, including fixing of necessary butt hinges and screws and applying a priming coat of approved steel primer. | | | | |
| | 10.13.1 | Fixing with 15x3 mm lugs 10 cm long embedded in cement concrete block 15x10x10 cm of C.C. 1:3:6 (1 Cement : 3 coarse sand : 6 graded stone aggregate 20 mm nominal size). | kg | 9967 | 106.45 | 10,60,987.15 |
| | 10.15 | Providing and fixing M.S. Tubular frames for doors, windows, ventilators and cupboard with rectangular/ L-Type sections, made of 1.60 mm thick M.S. Sheet, joints mitred, welded and grinded finish, with profiles of required size, including fixing of necessary butt hinges and screws and applying a priming coat of approved steel primer. | | | | |

| S. No. | DSR 2019 | Description | Unit | Quantity | Rate (In Rs) | Amount (In Rs) |
|--------|----------|---|------|--------------------|--------------|-----------------------|
| | 10.15.1 | Fixing with 15x3 mm lugs 10 cm long embedded in cement concrete block 15x10x10 cm of C.C. 1:3:6 (1 Cement : 3 coarse sand : 6 graded stone aggregate 20 mm nominal size). | kg | 25549 | 137.30 | 35,07,877.70 |
| 8.07 | 10.16 | Steel work in built up tubular (round, square or rectangular hollow tubes etc.) trusses etc., including cutting, hoisting, fixing in position and applying a priming coat of approved steel primer, including welding and bolted with special shaped washers etc. complete. | | | | |
| | 10.16.1 | Hot finished welded type tubes | kg | 8721 | 143.45 | 12,51,027.45 |
| 8.08 | 10.25 | Steel work welded in built up sections/ framed work, including cutting, hoisting, fixing in position and applying a priming coat of approved steel primer using structural steel etc. as required. | | | | |
| | 10.25.2 | In gratings, frames, guard bar, ladder, railings, brackets, gates and similar works | kg | 3663 | 131.00 | 4,79,853.00 |
| | 10.25.1 | In stringers, treads, landings etc. of stair cases, including use of chequered plate wherever required, all complete | kg | 100 | 93.65 | 9,365.00 |
| 8.09 | 10.26 | Providing and fixing hand rail of approved size by welding etc. to steel ladder railing, balcony railing, staircase railing and similar works, including applying priming coat of approved steel primer. | | | | |
| | 10.26.1 | M.S. tube | kg | | 145.65 | - |
| 8.10 | 10.28 | Providing and fixing stainless steel (Grade 304) railing made of Hollow tubes, channels, plates etc., including welding, grinding, buffing, polishing and making curvature (wherever required) and fitting the same with necessary stainless steel nuts and bolts complete, i/c fixing the railing with necessary accessories & stainless steel dash fasteners , stainless steel bolts etc., of required size, on the top of the floor or the side of waist slab with suitable arrangement as per approval of Engineer-incharge, (for payment purpose only weight of stainless steel members shall be considered excluding fixing accessories such as nuts, bolts, fasteners etc.). | kg | 5258 | 575.45 | 30,25,716.10 |
| 8.11 | 10.29 | Providing & fixing fly proof wire gauze to windows, clerestory windows & doors with M.S. Flat 15x3 mm and nuts & bolts complete. | | | | |
| | 10.29.2 | Stainless steel (grade 304) wire gauze of 0.5 mm dia wire and 1.4 mm aperture on both sides | Sqm | 684 | 929.55 | 6,35,812.20 |
| 8.12 | 10.30 | Providing & fixing glass panes with putty and glazing clips in steel doors, windows, clerestory windows, all complete with : | | | | |
| | 10.30.1 | 4.0 mm thick glass panes | Sqm | 1372 | 900.55 | 12,35,554.60 |
| | | Total of sub-head (8.0) | | 14389241.85 | | 1,43,89,241.85 |
| 9.0 | 11 | Flooring | | | | |

| S. No. | DSR 2019 | Description | Unit | Quantity | Rate (In Rs) | Amount (In Rs) |
|--------|----------|--|-------|----------|--------------|----------------|
| 9.01 | 11.3 | Cement concrete flooring 1:2:4 (1 cement : 2 coarse sand : 4 graded stone aggregate) finished with a floating coat of neat cement, including cement slurry, but excluding the cost of nosing of steps etc. complete. | | | | |
| | 11.3.1 | 40 mm thick with 20 mm nominal size stone aggregate | Sqm | 69 | 498.35 | 34,386.15 |
| 0.01 | 11.5 | 62 mm thick cement concrete flooring with concrete hardener topping, under layer 50 mm thick cement concrete 1:2:4 (1 cement : 2 coarse sand : 4 graded stone aggregate 20mm nominal size) and top layer 12mm thick cement hardener consisting of mix 1:2 (1 cement hardener mix : 2 graded stone aggregate, 6mm nominal size) by volume, hardening compound mixed @ 2 litre per 50 kg of cement or as per manufacture's specifications. This includes cost of cement slurry, but excluding the cost of nosing of steps etc. complete. | | | | |
| | | | Sqm | 1316 | 854.30 | 11,24,258.80 |
| | 11.8 | Extra for making chequers of approved pattern on cement concrete floors, steps, landing, pavements etc. | Sqm | 1216 | 63.20 | 76,851.20 |
| 9.02 | 11.13 | Providing and fixing glass strips in joints of terrazo/ cement concrete floors. | | | | |
| | 11.13.1 | 40 mm wide and 4 mm thick | Metre | 203 | 75.15 | 15,255.45 |
| 9.03 | 11.23 | Marble stone flooring with 18 mm thick marble stone, as per sample of marble approved by Engineer-in-charge, over 20 mm (average) thick base of cement mortar 1:4 (1 cement : 4 coarse sand) laid and jointed with grey cement slurry, including rubbing and polishing complete with : Note : Qty. shall be executed in marble strips of width upto 50mm. | | | | |
| | 11.23.3 | Agaria White | Sqm | 327 | 2730.05 | 8,92,726.35 |
| | 11.23.5 | Udaipur green marble | Sqm | | 1991.50 | - |
| 9.04 | 11.26 | Kota stone slab flooring over 20 mm (average) thick base laid over and jointed with grey cement slurry mixed with pigment to match the shade of the slab, including rubbing and polishing complete with base of cement mortar 1 : 4 (1 cement : 4 coarse sand) : | | | | |
| | 11.26.1 | 25 mm thick. | Sqm | 6156 | 1531.85 | 94,30,068.60 |
| 9.05 | 11.27 | Kota stone slabs 20 mm thick in risers of steps, skirting, dado and pillars laid on 12 mm (average) thick cement mortar 1:3 (1 cement: 3 coarse sand) and jointed with grey cement slurry mixed with pigment to match the shade of the slabs, including rubbing and polishing complete. | Sqm | 522 | 1810.05 | 9,44,846.10 |
| 9.06 | 11.31 | Extra for pre finished nosing in treads of steps of Kota stone/ sand stone slab. | Metre | 882 | 148.10 | 1,30,624.20 |
| | | | | | | - |

| S. No. | DSR 2019 | Description | Unit | Quantity | Rate (In Rs) | Amount (In Rs) |
|--------|----------|---|------|----------|--------------|----------------|
| 9.07 | 11.40 | Providing and laying rectified Glazed Ceramic floor tiles of size 300x300 mm or more (thickness to be specified by the manufacturer), of 1st quality conforming to IS : 15622, of approved make, in all colours, shades, except White, Ivory, Grey, Fume Red Brown, laid on 20 mm thick Cement Mortar 1:4 (1 Cement : 4Coarse sand), jointing with grey cement slurry @ 3.3 kg/ sqm including pointing the joints with white cement and matching pigments etc., complete. | Sqm | 1040 | 1170.70 | 12,17,528.00 |
| 9.08 | 11.41 | Providing and laying full body (Homogeneous) Vitrified floor tiles in different sizes (thickness to be specified by the manufacturer) with water absorption less than 0.08% and conforming to IS: 15622, of approved make, in all colours and shades, laid on 20mm thick cement mortar 1:4 (1 cement : 4 coarse sand), jointing with grey cement slurry @ 3.3kg/sqm including grouting the joints with white cement and matching pigments etc., complete. | | | | |
| | 11.41.2 | Size of Tile 600x600 mm | Sqm | 1657 | 1500.55 | 24,86,411.35 |
| 9.09 | 11.46 | Providing and laying full body (Homogeneous) Vitrified tiles in different sizes (thickness to be specified by manufacturer), with water absorption less than 0.08 % and conforming to I.S. 15622, of approved make, in all colours & shade, in skirting, riser of steps, over 12 mm thick bed of cement mortar 1:3 (1 cement: 3 coarse sand), jointing with grey cement slurry @ 3.3kg/sqm including grouting the joint with white cement & matching pigments etc. complete. | | | | |
| | 11.46.2 | Size of Tile 600x600 mm | Sqm | 172 | 1545.85 | 2,65,886.20 |
| 9.10 | 23.7 | Supplying, filling, spreading & leveling coarse sand of size range 1.5 mm to 2 mm in recharge pit, in required thickness over gravel layer, for all leads & lifts, all complete as per direction of Engineer - incharge. | Cum | 6 | 1326.55 | 7,959.30 |
| 9.11 | 16.89 | Providing and laying matt finished vitrified tile of size 300x300x9.8mm having with water absorption less than 0.5% and conforming to IS: 15622 of approved make in all colours and shades in for outdoor floors such as footpath, court yard, multi modals location etc., laid on 20mm thick base of cement mortar 1:4 (1 cement : 4 coarse sand) in all shapes & patterns including grouting the joints with white cement mixed with matching pigments etc. complete as per direction of Engineerin-Charge. | Sqm | 387 | 1264.80 | 4,89,477.60 |

| S. No. | DSR 2019 | Description | Unit | Quantity | Rate (In Rs) | Amount (In Rs) |
|--------|----------|---|------|-------------------|--------------|-----------------------|
| 9.12 | 16.90 | Providing and laying tactile tile (for vision impaired persons as per standards) of size 300x300x9.8mm having with water absorption less than 0.5% and conforming to IS:15622 of approved make in all colours and shades in for outdoor floors such as footpath, court yard, multi modals location etc., laid on 20mm thick base of cement mortar 1:4 (1 cement : 4 coarse sand) in all shapes & patterns including grouting the joints with white cement mixed with matching pigments etc. complete as per direction of Engineer-in-Charge. | Sqm | 70 | 1933.75 | 1,35,362.50 |
| | | Total of sub-head (9.0) | | 17251641.8 | | 1,72,51,641.80 |
| 10.0 | 12 | Roofing | | | | |
| 10.01 | 12.22 | Making khurras 45x45 cm with average minimum thickness of 5 cm cement concrete 1:2:4 (1 cement : 2 coarse sand : 4 graded stone aggregate of 20 mm nominal size) over P.V.C. sheet 1 m x 1 m x 400 micron, finished with 12 mm cement plaster 1:3 (1 cement : 3 coarse sand) and a coat of neat cement, rounding the edges and making and finishing the outlet complete. | Each | 124 | 244.05 | 30,262.20 |
| 10.02 | 12.47 | Providing & fixing UV stabilised fiberglass reinforced plastic sheet roofing up to any pitch, including fixing with polymer coated 'J' or 'L' hooks, bolts & nuts 8mm dia. G.I plain/bitumen washers complete but excluding the cost of purlins, rafters, trusses etc. The sheets shall be manufactured out of 2400 TEX panel rovigs incorporating minimum 0.3% ultra-violet stabiliser in resin system under approximately 2400 psi and hot cured. They shall be of uniform pigmentation and thickness without air pockets and shall conform to IS 10192 and IS 12866. The sheets shall be opaque or translucent, clear or pigmented, textured or smooth as specified. | | | | |
| | 12.47.2 | 2 mm thick flat | Sqm | | 999.35 | - |
| 10.03 | 12.50 | Providing and fixing pre-coated galvanised iron profile sheets (size, shape and pitch of corrugation as approved by Engineer-in-charge) 0.50 mm (+ 0.05 %) total coated thickness with zinc coating 120 grams per sqm as per IS: 277, in 240 mpa steel grade, 5-7 microns epoxy primer on both side of the sheet and polyester top coat 15-18 microns. Sheet should have protective guard film of 25 microns minimum to avoid scratches during transportation and should be supplied in single length upto 12 metre or as desired by Engineer-in-charge. The sheet shall be fixed using self drilling /self tapping screws of size (5.5x 55 mm) with EPDM seal, complete upto any pitch in horizontal/ vertical or curved surfaces, excluding the cost of purlins, rafters and trusses and including cutting to size and shape wherever required. | Sqm | 391 | 627.55 | 2,45,372.05 |

| S. No. | DSR 2019 | Description | Unit | Quantity | Rate (In Rs) | Amount (In Rs) |
|--------|----------|---|--|----------|--------------|--------------------|
| 10.04 | 12.51 | Providing and fixing pre-coated galvanised steel sheet roofing accessories 0.50 mm (+0.05 %) total coated thickness, Zinc coating 120 grams per sqm as per IS: 277, in 240 mpa steel grade, 5-7 microns epoxy primer on both side of the sheet and polyester top coat 15-18 microns using self drilling/ self tapping screws complete : | | | | |
| | 12.51.2 | Flashings/ Aprons.(Upto 600 mm) | Metre | 12 | 368.60 | 4,423.20 |
| | 12.51.4 | Barge board (upto 300 mm) | Metre | 23 | 355.80 | 8,183.40 |
| | 12.51.6 | Gutter (600 mm over all girth) | Metre | 23 | 1041.75 | 23,960.25 |
| | | Total of sub-head (10.0) | | | | 3,12,201.10 |
| 11.0 | 13 | Finishing | | | | |
| 11.01 | 13.4 | 12 mm cement plaster of mix | | | | |
| | 13.4.2 | 1:6 (1 cement: 6 coarse sand) | Sqm | 18367 | 263.55 | 48,40,622.85 |
| 11.02 | 13.5 | 15 mm cement plaster on rough side of single or half brick wall of mix: | | | | |
| | 13.5.2 | 1:6 (1 cement: 6 coarse sand) | Sqm | 12702 | 303.90 | 38,60,137.80 |
| 11.03 | 13.16 | 6 mm cement plaster of mix | | | | |
| | 13.16.1 | 1:3 (1 cement : 3 fine sand) | Sqm | 15045 | 227.35 | 34,20,480.75 |
| 11.04 | 13.18 | Neat cement punning | Sqm | 143 | 62.75 | 8,973.25 |
| 11.05 | 13.11 | 18 mm cement plaster in two coats under layer 12 mm thick cement plaster 1:5 (1 cement : 5 coarse sand) finished with a top layer 6 mm thick cement plaster 1:6 (1 cement : 6 fine sand) | Sqm | 8559 | 399.30 | 34,17,608.70 |
| 11.06 | 13.21 | Extra for providing and mixing water proofing material in cement plaster work in proportion recommended by the manufacturers. | per bag of 50kg cement used in the mix | 1354 | 59.75 | 80,901.50 |
| 11.07 | 13.37 | White washing with lime to give an even shade : | | | | |
| | 13.37.1 | New work (three or more coats) | Sqm | 450 | 28.55 | 12,847.50 |
| 11.08 | 13.42 | Distemping with 1st quality acrylic distemper (ready mixed) having VOC content less than 50 gms/litre, of approved manufacturer, of required shade and colour complete, as per manufacturer's specification. | | | | |
| | 13.42.1 | Two or more coats on new work | Sqm | 45504 | 87.15 | 39,65,673.60 |
| 11.09 | 13.43 | Applying one coat of water thinnable cement primer of approved brand and manufacture on wall surface : | | | | |
| | 13.43.1 | Water thinnable cement primer | Sqm | 45504 | 60.00 | 27,30,240.00 |
| 11.10 | 13.47 | Finishing walls with Premium Acrylic Smooth exterior paint with Silicone additives of required shade: | | | | |
| | 13.47.1 | New work (Two or more coats applied @ 1.43 ltr/10 sqm over and including priming coat of exterior primer applied @ 2.20 kg/10 sqm) | Sqm | 16615 | 161.15 | 26,77,507.25 |

| S. No. | DSR 2019 | Description | Unit | Quantity | Rate (In Rs) | Amount (In Rs) |
|--------|-----------|--|------|-----------------|--------------|-----------------------|
| 11.11 | 13.50 | Applying priming coat: | | | | |
| | 13.50.3 | With ready mixed red oxide zinc chromate primer of approved brand and manufacture on steel galvanised iron/ steel works | Sqm | 665 | 50.70 | 33,715.50 |
| 0.01 | 13.50 | Finishing with Epoxy paint (two or more coats) at all locations prepared and applied as per manufacturer's specifications including appropriate priming coat, preparation of surface, etc. complete. | | | | |
| | 13.52.2 | On concrete work | Sqm | 1996 | 189.40 | 3,78,042.40 |
| 11.12 | 13.61 | Painting with synthetic enamel paint of approved brand and manufacture to give an even shade : | | | | |
| | 13.61.1 | Two or more coats on new work | Sqm | 4664 | 121.55 | 5,66,909.20 |
| 11.13 | 13.80 | Providing and applying white cement based putty of average thickness 1 mm, of approved brand and manufacturer, over the plastered wall surface to prepare the surface even and smooth complete. | Sqm | 1421 | 115.15 | 1,63,628.15 |
| | | Total of sub-head (11.0) | | 26157288 | | 2,61,57,288.45 |
| 12.0 | 21 | Aluminium Work | | | | |
| 12.01 | 21.1 | Providing and fixing aluminium work for doors, windows, ventilators and partitions with extruded built up standard tubular sections/appropriate Z sections and other sections of approved make conforming to IS: 733 and IS: 1285, fixing with dash fasteners of required dia and size, including necessary filling up the gaps at junctions, i.e. at top, bottom and sides with required EPDM rubber/neoprene gasket etc. Aluminium sections shall be smooth, rust free, straight, mitred and jointed mechanically wherever required including cleat angle, Aluminium snap beading for glazing / paneling, C.P. brass / stainless steel screws, all complete as per architectural drawings and the directions of Engineer-in-charge. (Glazing, paneling and dash fasteners to be paid for separately) : | | | | |
| | 21.1.1 | For Fixed Portion | | | | |
| | 21.1.1.2 | Powder coated aluminium (minimum thickness of powder coating 50 micron) | kg | 200 | 456.30 | 91,260.00 |
| 12.02 | 21.1.2 | For shutters of doors, windows & ventilators including providing and fixing hinges/ pivots and making provision for fixing of fittings wherever required including the cost of EPDM rubber / neoprene gasket required (Fittings shall be paid for separately) | | | | |
| | 21.1.2.2 | Powder coated aluminium (minimum thickness of powder coating 50 micron) | kg | 270 | 546.35 | 1,47,514.50 |
| 12.03 | 21.3 | Providing and fixing glazing in aluminium door, window, ventilator shutters and partitions etc. with EPDM rubber / neoprene gasket etc. complete as per the architectural drawings and the directions of Engineer-in-charge . (Cost of aluminium snap beading shall be paid in basic item): | | | | |
| | 21.3.1 | With float glass panes of 4.00 mm thickness | Sqm | | 999.60 | - |

| S. No. | DSR 2019 | Description | Unit | Quantity | Rate (In Rs) | Amount (In Rs) |
|--------|-----------|---|------|---------------|--------------|--------------------|
| | 21.3.2 | With float glass panes of 5 mm thickness (weight not less than 12.50 kg/ sqm) | Sqm | 21 | 1296.40 | 26,576.20 |
| | 21.3.3 | With float glass panes of 8 mm thickness (weight not less than 20 kg/ sqm) | Sqm | 28 | 1462.35 | 40,945.80 |
| 12.04 | 21.4 | Providing and fixing double action hydraulic floor spring of approved brand and manufacture conforming to IS : 6315, having brand logo embossed on the body / plate with double spring mechanism and door weight upto 125 kg, for doors, including cost of cutting floors, embedding in floors as required and making good the same matching to the existing floor finishing and cover plates with brass pivot and single piece M.S. sheet outer box with slide plate etc. complete as per the direction of Engineer-in-charge. | | | | |
| | 21.4.1 | With stainless steel cover plate minimum 1.25 mm thickness | Each | 14 | 2412.50 | 33,775.00 |
| 12.05 | 21.13 | Providing and fixing Brass 100mm mortice latch and lock with 6 levers without pair of handles (best make of approved quality) for aluminium doors including necessary cutting and making good etc. complete. | Each | 7 | 458.55 | 3,209.85 |
| | 21.16 | Providing and fixing aluminium round shape handle of outer dia 100 mm with SS screws etc. complete as per direction of Engineer-incharge | | | | |
| | 21.16.2 | Powder coated minimum thickness 50 micron aluminium | Each | 28 | 83.60 | 2,340.80 |
| | | Total of sub-head (12.0) | | 345622 | | 3,45,622.15 |
| 13.0 | 22 | Water Proofing | | | | |
| 13.01 | 22.3 | Providing and laying water proofing treatment to vertical and horizontal surfaces of depressed portions of W.C., kitchen and the like consisting of: | | | | |
| | | (i) Ist course of applying cement slurry @ 4.4 kg/sqm mixed with water proofing compound conforming to IS 2645 in recommended proportions including rounding off junction of vertical and horizontal surface. | | | | |
| | | (ii) IInd course of 20 mm cement plaster 1:3 (1 cement : 3 coarse sand) mixed with water proofing compound in recommended proportion including rounding off junction of vertical and horizontal surface. | | | | |
| | | (iii) IIIrd course of applying blown or residual bitumen applied hot at 1.7 kg. per sqm of area. | | | | |
| | | (iv) IVth course of 400 micron thick PVC sheet. (Overlaps at joints of PVC sheet should be 100 mm wide and pasted to each other with bitumen @ 1.7 kg/sqm). | Sqm | 963 | 705.70 | 6,79,589.10 |

| S. No. | DSR 2019 | Description | Unit | Quantity | Rate (In Rs) | Amount (In Rs) |
|--------|----------|--|------|----------|--------------|----------------|
| | 22.4 | Providing and Placing in position suitable PVC water stops conforming to IS:12200 for construction/ expansion joints between two RCC members and fixed to the reinforcement with binding wire before pouring concrete etc. complete : | | | | |
| | 22.4.1 | Serrated with central bulb (225 mm wide, 8-11 mm thick) | Sqm | | 283.20 | - |
| | | | | | | |
| 13.02 | 22.7 | Providing and laying integral cement based water proofing treatment including preparation of surface as required for treatment of roofs, balconies, terraces etc consisting of following operations: | | | | |
| | | a) Applying a slurry coat of neat cement using 2.75 kg/sqm of cement admixed with water proofing compound conforming to IS. 2645 and approved by Engineer-in-charge over the RCC slab including adjoining walls upto 300 mm height including cleaning the surface before treatment. | | | | |
| | | b) Laying brick bats with mortar using broken bricks/brick bats 25 mm to 115 mm size with 50% of cement mortar 1:5 (1 cement : 5 coarse sand) admixed with water proofing compound conforming to IS : 2645 and approved by Engineer-in-charge over 20 mm thick layer of cement mortar of mix 1:5 (1 cement :5 coarse sand) admixed with water proofing compound conforming to IS : 2645 and approved by Engineer-in-charge to required slope and treating similarly the adjoining walls upto 300 mm height including rounding of junctions of walls and slabs | | | | |
| | | c) After two days of proper curing applying a second coat of cement slurry using 2.75 kg/ sqm of cement admixed with water proofing compound conforming to IS : 2645 and approved by Engineerin-charge. | | | | |
| | | d) Finishing the surface with 20 mm thick jointless cement mortar of mix 1:4 (1 cement :4 coarse sand) admixed with water proofing compound conforming to IS : 2645 and approved by Engineerin-charge including laying glass fibre cloth of approved quality in top layer of plaster and finally finishing the surface with trowel with neat cement slurry and making pattern of 300x300 mm square 3 mm deep. | | | | |
| | | e) The whole terrace so finished shall be flooded with water for a minimum period of two weeks for curing and for final test."All above operations to be done in order and as directed and specified by the Engineer-in-Charge : | | | | |
| | 22.7.1 | With average thickness of 120 mm and minimum thickness at khurra as 65 mm. | Sqm | 5285 | 1398.50 | 73,91,072.50 |
| | | | | | | |

| S. No. | DSR 2019 | Description | Unit | Quantity | Rate (In Rs) | Amount (In Rs) |
|--------|------------------|--|------|----------------|--------------|---------------------|
| 13.03 | 22.23 | Providing and applying integral crystalline slurry of hydrophilic in nature for waterproofing treatment to the RCC structures like retaining walls of the basement, water tanks, roof slabs, podiums, reservoir, sewage & water treatment plant, tunnels / subway and bridge deck etc., prepared by mixing in the ratio of 5 : 2 (5 parts integral crystalline slurry : 2 parts water) for vertical surfaces and 3 : 1 (3 parts integral crystalline slurry : 1 part water) for horizontal surfaces and applying the same from negative (internal) side with the help of synthetic fiber brush. The material shall meet the requirements as specified in ACI-212-3R-2010 i.e by reducing permeability of concrete by more than 90% compared with control concrete as per DIN 1048 and resistant to 16 bar hydrostatic pressure on negative side. The crystalline slurry shall be capable of self-healing of cracks up to a width of 0.50mm. The work shall be carried out all complete as per specification and the direction of the engineer-in-charge. The product performance shall carry guarantee for 10 years against any leakage. | | | | - |
| | 22.23.1 | For vertical surface two coats @ 0.70 kg per sqm | Sqm | 554 | 484.45 | 2,68,385.30 |
| | 22.23.2 | For horizontal surface one coat @1.10 kg per sqm. | Sqm | 296 | 373.40 | 1,10,526.40 |
| | | Total of sub-head (13.0) | | 8449573 | | 84,49,573.30 |
| 14.0 | 16 | Road Work | | | | |
| 14.01 | 16.1 | Preparation and consolidation of sub grade with power road roller of 8 to 12 tonne capacity after excavating earth to an average of 22.5 cm depth, dressing to camber and consolidating with road roller including making good the undulations etc. and re-rolling the sub grade and disposal of surplus earth with all lead and lift. | Sqm | 6886 | 156.75 | 10,79,349.15 |
| 0.01 | 16.7 | Brick edging in full brick width and half brick depth including excavation, refilling and disposal of surplus earth lead upto 50 metres. | mtr | 864 | 167.80 | 1,44,972.49 |
| | | | | | | - |
| 0.01 | 16.7 | Supplying, stacking and Spreading 6 mm thick red bajri, watering and rolling complete including preparation of the surface and rolling. | sqm | 810 | 19.90 | 16,117.01 |
| 14.02 | 16.11 | Dry stone pitching 22.5 cm thick including supply of stones and preparing surface complete | Sqm | | 730.20 | - |
| 14.03 | 16.11 (Modified) | Deduct for using available stone of size 15 cm x 22.5 cm for dry stone pitching. (Rate is below relevant item) | Sqm | | -242.95 | - |

| S. No. | DSR 2019 | Description | Unit | Quantity | Rate (In Rs) | Amount (In Rs) |
|--------|----------|---|-------|----------|--------------|----------------|
| 14.03 | 16.53 | Providing and fixing concertina coil fencing with punched tape concertina coil 600 mm dia 10 metre openable length (total length 90 m), having 50 nos rounds per 6 metre length, upto 3 m height of wall with existing angle iron 'Y' shaped placed 2.4m or 3.00 m apart and with 9 horizontal R.B.T. reinforced barbed wire, stud tied with G.I. staples and G.I. clips to retain horizontal, including necessary bolts or G.I. barbed wire tied to angle iron, all complete as per direction of Engineer-in-charge, with reinforced barbed tape(R.B.T.) / Spring core (2.5mm thick) wire of high tensile strength of 165 kg/ sq.mm with tape (0.52 mm thick) and weight 43.478 gm/ metre (cost of M.S. angle, C.C. blocks shall be paid separately) | Metre | 1346 | 290.80 | 3,91,416.80 |
| 14.04 | 16.19 | Supplying at site Angle iron post & strut of required size including bottom to be split and bent at right angle in opposite direction for 10 cm length and drilling holes upto 10 mm dia. etc. complete. | kg | 4090 | 92.40 | 3,77,916.00 |
| 14.05 | 16.62 | Providing and applying 2.5 mm thick road marking strips (retro- reflective) of specified shade/ colour using hot thermoplastic material by fully/ semi automatic thermoplastic paint applicator machine fitted with profile shoe, glass beads dispenser, propane tank heater and profile shoe heater, driven by experienced operator on road surface including cost of material, labour, T&P, cleaning the road surface of all dirt, seals, oil, grease and foreign material etc. complete as per direction of Engineer-in-charge and accordance with applicable specifications. | Sqm | 156 | 607.30 | 94,738.80 |
| 14.05 | 16.66 | Excavating holes upto 0.10 cum, including getting out the excavated soil, then returning the soil as deported in layers not exceeding 20 cm in depth, including consolidating and deposited layer by ramming watering etc., disposing of surplus excavated soil as directed with in a lead of 50 mm and lift upto 1.5 m. | | | | |
| | 16.66.1 | All kind of soil | each | 16 | 26.45 | 423.20 |
| 14.06 | 16.68 | Providing and laying 60mm thick factory made cement concrete interlocking paver block of M-30 grade made by block making machine with strong vibratory compaction, of approved size, design & shape, laid in required colour and pattern over and including 50mm thick compacted bed of coarse sand, filling the joints with line sand etc. all complete as per the direction of Engineer-in-charge. | Sqm | 90 | 859.35 | 77,341.50 |

| S. No. | DSR 2019 | Description | Unit | Quantity | Rate (In Rs) | Amount (In Rs) |
|--------|----------|---|------|----------|--------------|---------------------|
| 14.07 | 16.69 | Providing and laying at or near ground level factory made kerb stone of M-25 grade cement concrete in position to the required line, level and curvature, jointed with cement mortar 1:3 (1 cement: 3 coarse sand), including making joints with or without grooves (thickness of joints except at sharp curve shall not to more than 5mm), including making drainage opening wherever required complete etc. as per direction of Engineer-in-charge (length of finished kerb edging shall be measured for payment). (Precast C.C. kerb stone shall be approved by Engineer-in-charge). | Cum | 66 | 8376.15 | 5,52,825.90 |
| 14.08 | 16.75 | Providing and laying C.C. pavement of mix M-25 with ready mixed concrete from batching plant. The ready mixed concrete shall be laid and finished with screed board vibrator, vacuum dewatering process and finally finished by floating, brooming with wire brush etc. complete as per specifications and directions of Engineer-in-charge. (The panel shuttering work shall be paid for separately). (Note:- Cement content considered in this item is @ 330 kg/cum. Excess/less cement used as per design mix is payable/ recoverable separately). | Cum | 365 | 8663.05 | 31,62,013.25 |
| 14.09 | 16.76 | Deduct for using of M-20 grade concrete instead of M-25 grade concrete in C.C. pavement. | Cum | -365 | 188.30 | (68,729.50) |
| 14.10 | 16.3 | Supplying and stacking at site. | | | | |
| | 16.3.2 | 63 mm to 45 mm size stone aggregate | Cum | 315 | 1535.65 | 4,83,729.75 |
| 14.11 | 16.3.3 | 53 mm to 22.4 mm size stone aggregate | Cum | 315 | 1749.75 | 5,51,171.25 |
| 14.12 | 16.3.10 | Moorum | Cum | 242 | 807.80 | 1,95,487.60 |
| 14.13 | 16.3.9 | Good Earth | Cum | 1175 | 483.90 | 5,68,572.82 |
| 14.13 | 16.4 | Laying, spreading and compacting stone aggregate of specified sizes to WBM specifications in uniform thickness, hand picking, rolling with 3 wheeled road/vibratory roller 8-10 tonne capacity in stages to proper grade and camber, applying and brooming requisite type of screening / binding material to fill up interstices of coarse aggregate, watering and compacting to the required density . | Cum | 773 | 767.25 | 5,93,084.25 |
| | | Total of sub-head (14.0) | | 8220430 | | 82,20,430.27 |
| 15.00 | | Non-Schedule Items - Civil | | | | |
| 15.01 | MR 1 | Supply and Installation of single bucket dustbin made out of SS 202 grade, Capacity of bucket will be 70 ltrs. with weight carrying capacity of 40 kg. Minimum Sheet thickness will be used 0.8 mm. Design shall be approved from Engineer-In-Charge. | Each | 5 | 5084.00 | 25,420.00 |

| S. No. | DSR 2019 | Description | Unit | Quantity | Rate (In Rs) | Amount (In Rs) |
|--------|----------|---|----------|----------|--------------|----------------|
| 15.02 | MR 2 | Supplying, installation and fixing Galvanized iron High mast pole for National flags of height 6 meter. Pole shall be conical in shape of bottom & Top diameter- 20mm, Thickness - 1.0mm including holes and other accessories. Diameter of the base shall be 110mm and thickness of base plate shall be minimum 2mm. The rate shall be inclusive of National flag of required size as per IS code with hoisting arrangements and including mounted base, base plate and all other accessories. | Each | 1 | 70242.00 | 70,242.00 |
| 16.03 | MR 3 | Providing and fixing of Outdoor signages of varying sizes and shapes using stainless steel (Grade 304) sheet of minimum 16G thickness brush finish 3 dimensional letters of required size filled with colour as desired by engineer, fixing with SS screws on walls, all completed as per manufacturer's specifications and direction of Engineer-in-charge. | Sqm | 9 | 22399.00 | 2,01,591.00 |
| 16.04 | MR 4 | Providing signage viz display/name plate and like of required size made out of 20 guage thick stainless steel (304 grade) including engraved subject matter, message (Hindi/English and / or bilingual), symbols, borders and logo etc. The engraved letter, borders etc. to be furnished with paint etc. of required colour scheme and the plate to be fixed to wooden/wall surface with 25mm long stainless steel spacer/stud all complete as per direction of Engineer in Charge. | Sq. inch | 3750 | 9.00 | 33,750.00 |
| #REF! | MR 6 | Providing and fixing 35mm thick factory made Machine pressed pre-laminated flush door exterior grade with SS Butt Hinges along with teak wood lipping on edges. The lamination sheet used shall be decorative high pressure of plain/ wood grain in gloss/ matt/ suede finish with high density protective surface layer and reverse side of adhesive bonding quality conforming to IS: 2046 Type S. | Sqm | 585 | 4930.00 | 28,84,050.00 |
| #REF! | MR 7 | Providing and laying cement concrete wall cladding to imitate brick or stone and like (size and thickness to be specified by the manufacturer), water absorption 3% to 6% conforming to IS: 1237:2001, of approved brand & manufacturer, in brick colours and shade as approved by the architect, on walls laid with cement based high polymer modified quick set tileadhesive (water based) conforming to IS: 15477, in average 6 mm thickness, including grouting of joints of 3mm wide using epoxy grout mix of 0.70 kg of organic coated filler of desired shade (0.10 kg of hardener and 0.20 kg of resin per kg), including filling / grouting and finishing complete as per direction of Engineer-in-charge. | Sqm | 204 | 2106.00 | 4,29,624.00 |

| S. No. | DSR 2019 | Description | Unit | Quantity | Rate (In Rs) | Amount (In Rs) |
|--------|-----------|--|---------|----------------|--------------|------------------------|
| #REF! | MR 8 | Graffiti painting on wall as approved logo of Eklavya (EMRS) by high gloss acrylic colour before making logo, prepare the surface clean, fill POP in voids, apply 1mm white birla putty and primer including material, labour and T&P etc. all complete under instruction of engineer-in-charge. | Sqm | 48 | 650.00 | 31,200.00 |
| #REF! | MR 8 | Providing & fixing G.I. chicken wire mesh of nominal size upto 20mm having 24 gauge thick with G.I. nails etc. to wall surface of dissimilar material viz RCC and brick work etc.all complete. | Sqm | 520 | 155.15 | 80,678.00 |
| | | | | | | - |
| | MR-9 | Basket ball- Board & Basket | one set | | 20000.00 | - |
| | | | | | | - |
| | MR-10 | Archery-Start stands | each | | 5000.00 | - |
| | | | | | | - |
| | MR-11 | Archery-Targets | each | | 5000.00 | - |
| | | | | | | - |
| | MR-12 | Archery-set of bows & Arrow | each | | 7000.00 | - |
| | | | | | | - |
| | MR-13 | Volley ball nets | each | | 5000.00 | - |
| | | | | | | - |
| | | Total of sub-head (16.0) (Non DSR) | | 1074833 | | 37,56,555.00 |
| | | TOTAL AMOUNT (DSR) | | | | 27,17,06,227.51 |
| | | TOTAL AMOUNT (NON DSR) | | | | 37,56,555.00 |
| | | | | | | |
| | | PLUMBING WORKS | | | | |
| | | | | | | |
| 17.0 | | Sanitary Installation (As per D.S.R.) | | | | |
| | | | | | | |
| 17.01 | 8.10 | Providing & fixing stone slab table rubbed, edges rounded and polished of size 75 X 50 cm deep and 1.8 cm thick fixed in urinal partitions by cutting a chase of appropriate width with chase cutter and embedding the stone in chase with epoxy grout or with cement concrete 1:2:4 (1 cement : 2 coarse sand : 4 graded stone aggregste 6mm nominal size) as per Engineer-in-charge and finished smooth | | | | |
| | 8.10.2 | Granite Stone of approved shade | sqm | 8 | 3216.90 | 24,126.75 |
| | | | | | | - |
| 17.02 | 17.10 | Providing and fixing Stainless Steel A ISI 304 (18/8) kitchen sink as per IS: 13983 with CI brackets and stainless steel waste with plug 40mm including painting of fittings and brackets, cutting and making good the walls wherever required. | | | | - |
| | 17.10.2 | Sink without drain board | | | | - |
| | 17.10.2.2 | 610X460 mm bowl depth 200mm. | Each | 48 | 2828.75 | 1,35,780.00 |
| | | | | | | - |
| 17.03 | 17.11 | Providing and fixing white vitreous china laboratory sink with C.I. brackets, C.P. brass chain with rubber plug, 40 mm C.P brass waste and 40mm C.P. brass trap with necessary C.P. brass unions complete, including painting of fittings and brackets, cutting and making good the wall wherever required : | | | | |
| | 17.11.2 | Size 600x450x200 mm | Each | 13 | 5460.45 | 70,985.85 |
| | | | | | | |

| S. No. | DSR 2019 | Description | Unit | Quantity | Rate (In Rs) | Amount (In Rs) |
|--------|------------|---|------|----------|--------------|----------------|
| 17.04 | 17.2 | Providing and fixing white vitreous china pedestal type water closet (European type W.C. pan) with seat and lid, 10 litre low level white P.V.C. flushing cistern, including flush pipe, with manually controlled device (handle lever), conforming to IS : 7231, with all fittings and fixtures complete, including cutting and making good the walls and floors wherever required : | | | | |
| | 17.2.1 | W.C. pan with ISI marked white solid plastic seat and lid | Each | 57 | 5260.95 | 2,99,874.15 |
| 17.05 | 17.16A | Providing and fixing 8 mm dia C.P./S.S. Jet with flexible tube upto 1 metre long with S.S. triangular plate to European type W.C. of quality and make as approved by Engineer - in-charge | Each | 57 | 297.55 | 16,960.35 |
| 17.06 | 17.70 | Providing and fixing PTMT Bottle Trap for Wash basin and sink. | | | | |
| | 17.70.1 | Bottle trap 31mm single piece moulded with height of 270 mm, effective length of tail pipe 260 mm from the centre of the waste coupling, 77 mm breadth with 25 mm minimum water seal, weighing not less than 260 gms. | Each | 63 | 335.25 | 21,120.75 |
| 17.07 | 17.5.1 (M) | Providing and fixing single white vitreous china flat back half stall urinal of size 580x380x350 mm with spreaders, unions, waste fitting and other couplings (all in C.P. brass) including making good the walls wherever required. | Each | 27 | 3076.95 | 83,077.52 |
| 17.08 | 17.72 | Providing & fixing PTMT towel ring trapezoidal shape 215 mm long 200 mm wide with minimum distance of 37 mm from wall face with concealed fittings arrangement of approved quality and colour weighing not less than 88 gms | Each | 93 | 228.20 | 21,222.60 |
| 17.09 | 18.49 | Providing and fixing C.P. brass bib cock of approved quality conforming to IS:8931 : | | | - | |
| | 18.49.1 | 15mm nominal bore | Each | 142 | 418.95 | 59,490.90 |
| 17.10 | 18.50 | Providing and fixing C.P. brass long nose bib cock of approved quality conforming to IS standards and weighing not less than 810 gms. | | | | |
| | 18.50.1 | 15mm nominal bore | Each | 296 | 618.8 | 1,83,164.80 |
| 17.09 | 18.54 | Providing and fixing PTMT bib cock of approved quality and colour. | | | | - |
| | 18.54.1 | 15mm nominal bore, 86 mm long, weighing not less than 88 gms | Each | | 116.55 | - |
| | 18.54.3 | 15 mm nominal bore, 165 mm long, weighing not less than 110 gms | Each | | 176.75 | - |
| 17.10 | 18.55 | Providing and fixing PTMT stop cock of approved quality and colour. | | | | |
| | 18.55.3 | Concealed stop cock, 15 mm nominal bore, 108 mm long, weighing not less than 108 gms (For Shower) | Each | | 606.25 | - |

| S. No. | DSR 2019 | Description | Unit | Quantity | Rate (In Rs) | Amount (In Rs) |
|--------|-----------|--|------|----------|--------------|----------------|
| 0.01 | 18.52 | Providing and fixing C.P. brass stop cock (concealed) of standard design and of approved make conforming to IS:8931. | | | | |
| | 18.52.1 | 15 mm nominal bore (For Shower) | Each | 196 | 606.25 | 1,18,825.00 |
| 0.02 | 18.53 | Providing and fixing C.P. brass angle valve for basin mixer and points of approved quality conforming to IS:8931 | | | | |
| | 18.53.1 | 15 mm nominal bore (For Shower) | Each | 463 | 532 | 2,46,316.00 |
| 17.11 | 18.63 | Providing and fixing PTMT angle stop cock 15 mm nominal bore, weighing not less than 85 gms | Each | | 155.35 | - |
| 0.01 | 18.75 | Providing and fixing PTMT extension nipple for water tank pipe, fittings of approved quality and colour. | Each | | | |
| | | a) 25 mm nominal bore , weighing not less than 62 gms | | 73 | 155.35 | 11,340.55 |
| | | | | | | - |
| 17.12 | 17.7 | Providing and fixing wash basin with C.I. brackets, 15 mm C.P. brass pillar taps, 32 mm C.P. brass waste of standard pattern, including painting of fittings and brackets, cutting and making good the walls wherever require: | Each | | | |
| | 17.7.4 | White Vitreous China Flat back wash basin size 550x400 mm with single 15 mm C.P. brass pillar tap | | 141 | 2510.45 | 3,53,973.45 |
| 17.12 | 17.7B | Providing and fixing wash basin with C.I. brackets, 15 mm PTMT pillar cock, 32 mm PTMT waste coupling of standard pattern, including painting of fittings and brackets, cutting and making good the walls wherever required. White Vitreous China Flat back wash basin size 550x400 mm with single 15 mm PTMT pillar cock | Each | | 2398.70 | - |
| | | | | | | - |
| 17.13 | 17.28 | Providing & fixing PVC waste pipe for sink including PVC waste fitting Complete | | | | - |
| | 17.28.2 | Flexible Pipe | | | | - |
| | 17.28.2.1 | 32mm Dia | Each | 233 | 101.10 | 23,556.30 |
| 17.14 | 17.34 | Providing and fixing toilet paper holder : | | | | - |
| | 17.34.1 | C.P. brass | Each | 57 | 538.75 | 30,708.75 |
| 17.15 | 18.21 | Providing and fixing uplasticised PVC connection pipe with brass unions | | | | - |
| | 18.21.2 | 45 cm length | | | | - |
| | 18.21.2.1 | 15 mm nominal bore | Each | 423 | 83.00 | 35,109.00 |
| | | | | | | - |
| 17.16 | 17.1 | Providing and fixing water closet squatting pan (Indian type W.C. pan) with 100 mm sand cast Iron P or S trap, 10 litre low level white P.V.C. flushing cistern, including flush pipe, with manually controlled device (handle lever) IS : 7231, with all fittings and fixtures complete, including cutting and making good the walls and floors wherever required: | | | | - |
| | 17.1.1 | White Vitreous china Orissa pattern W.C. pan of size 580 x 440 mm with integral type foot rests | Each | 110 | 5421.50 | 5,96,365.00 |
| | | | | | | - |

| S. No. | DSR 2019 | Description | Unit | Quantity | Rate (In Rs) | Amount (In Rs) |
|--------|----------|---|------|----------|--------------|----------------|
| 17.17 | 18.65 | Providing and fixing PTMT soap Dish Holder having length of 138mm, breadth 102mm, height of 75mm with concealed fitting arrangements, weighing not less than 106 gms. | Each | 181 | 130.50 | 23,620.50 |
| | | | | | | - |
| 17.18 | 17.71 | Providing and fixing PTMT liquid soap container 109 mm wide, 125 mm high and 112 mm distance from wall of standard shape with bracket of the same materials with snap fittings of approved quality and colour, weighing not less than 105 gms. | Each | 59 | 158.55 | 9,354.45 |
| | | | | | | |
| 17.19 | 17.73 | Providing and fixing PTMT towel rail complete with brackets fixed to wooden cleats with CP brass screws with concealed fittings arrangement of approved quality and colour. | | | | - |
| | 17.73.2 | 600 mm long towel rail with total length of 645 mm, width 78 mm and effective height of 88 mm, weighing not less than 190 gms. | Each | 132 | 595.50 | 78,606.00 |
| | | | | | | |
| 17.20 | 18.64 | Providing and fixing PTMT swivelling shower, 15 mm nominal bore, weighing not less than 40 gms | Each | 132 | 151.90 | 20,050.80 |
| | | | | | | |
| | | Sanitary Installations work (Non-Scheduled Items) | | | | |
| | | | | | | |
| 17.21 | MR 14 | Providing and fixing U-shaped stainless steel grab bar (for differently abled person) of size 600mm wall mounted, movable (horizontally and vertically) with necessary dash fastener etc. all complete. (Basic rate of material shall not be less than Rs.3900 each) | Each | 5 | 5700.00 | 28,500.00 |
| | | | | | | |
| 17.22 | MR 15 | Providing and fixing Oval Shape wash basin of size 560x450mm with C.I. brackets/rag bolt of required size, 15 mm PTMT pillar taps long neck with aerator, 32 mm PTMT waste coupling of standard pattern, including painting of fittings and brackets, cutting and making good the walls wherever require complete as per direction of Engineer in Charge | Each | 31 | 4865.00 | 1,50,815.00 |
| | | | | | | |
| 17.23 | MR 16 | Providing and fixing 600 x 450 mm beveled edge mirror of superior glass (of approved quality) fixed with stainless steel studs, complete with cutting, making holes, studs, all fittings, screws, washers and making good the walls. | Each | 177 | 849.59 | 1,50,377.43 |
| | | | | | | |
| 17.24 | MR 17 | Providing & fixing stainless steel robe plate/pegs (hook) having three pegs (hook) in one strip (weight shall not be less than 120 grams) of superior quality with necessary screws etc. complete. | Each | 200 | 281.00 | 56,200.00 |
| | | | | | | |
| 17.25 | MR 18 | Providing and fixing C.P. brass swan neck foam flow pillar cock of approved quality and conforming to IS standards. a) 15mm nominal bore | Each | 34 | 639.50 | 21,743.00 |
| | | | | | | |

| S. No. | DSR 2019 | Description | Unit | Quantity | Rate (In Rs) | Amount (In Rs) |
|---------|-----------|---|-------|----------|--------------|---------------------|
| 17.26 | MR 19 | Providing and fixing C.P. brass long body nozzle bib cock (two way) of approved quality conforming to IS standards and weighing not less than 810 gms. | | | | |
| 17.26.1 | | a) 15 mm nominal bore | Each | 28 | 643.55 | 18,019.40 |
| 17.27 | MR 20 | Providing & fixing stainless steel butterfly robe pegs (hook) having three hooks of superior quality with necessary screws etc. complete. | Each | 196 | 207.00 | 40,572.00 |
| 17.28 | MR 21 | Providing and fixing PTMT extension nipple for water tank pipe, fittings of approved quality and colour. | | | | |
| 17.28.1 | | a) 32 mm nominal bore | | 35 | 141.50 | 4,952.50 |
| 17.28.2 | | b) 40 mm nominal bore | | 2 | 201.70 | 403.40 |
| | | Total of sub-head (17.0) (DSR) | | | | 24,63,629.47 |
| | | Total of sub-head (17.0) (Non DSR) | | | | 4,71,582.73 |
| 18.0 | | Internal Drainage Installations (As per D.S.R.) | | | | |
| 18.01 | 18.58 | Providing and fixing PTMT grating of approved quality and colour | | | | |
| | 18.58.1 | Circular type | | | | |
| | 18.58.1.1 | 100 mm nominal dia | Each | 220.00 | 37.90 | 8,338.00 |
| | 18.58.1.2 | 125 mm nominal dia with 25mm waste hole. | Each | 73.00 | 51.25 | 3,741.25 |
| 18.02 | 12.41 | Providing & fixing on wall face unplasticised -Rigid PVC rain water pipes conforming to IS:13592 Type A including jointing with seal ring conforming to IS:5382 leaving 10 mm gap for thermal expansion. (i)Single socketed pipes. | | | | |
| | 12.41.2 | 110 mm diameter | Metre | 504.00 | 305.05 | 1,53,745.20 |
| 18.03 | 12.42. | Providing, fixing on wall face unplasticised - PVC moulded fittings /accessories for unplasticised - Rigid PVC rain water pipes conforming to IS ; 13592 Type A including jointing with seal ring conforming to IS ; 5382 leaving 10 mm gap for thermal expansion. | | | | |
| | 12.42.1.2 | Coupler -110 mm diameter | Each | 57.00 | 117.80 | 6,714.60 |
| | 12.42.5.2 | Bend -87.5 deg -110 mm diameter | Each | 53.00 | 129.85 | 6,882.05 |
| | 12.42.6.2 | Shoe -110mm shoe | Each | 53.00 | 113.80 | 6,031.40 |
| | 12.43 | Providing and fixing unplasticised -PVC pipe clips of approved design to unplasticised - PVC rain water pipes by means of 50x50x50 mm hard wood plugs, screwed with M.S. screws of required length, including cutting brick work and fixing in cement mortar 1:4 (1 cement : 4 coarse sand) and making good the wall etc. complete. | | | | |
| | 12.43.2 | 110mm | Each | 131.00 | 288.80 | 37,832.80 |

| S. No. | DSR 2019 | Description | Unit | Quantity | Rate (In Rs) | Amount (In Rs) |
|--------|----------|---|-------|----------|--------------|---------------------|
| 18.04 | MR 22 | Providing, fixing, jointing and testing in position of ISI marked UV stabilized uPVC pipes for soil, waste, and vent, Type-B as per IS : 13592 suitable for rubber ring joints, including all necessary specials and fittings (confirming to IS:14735) i.e. bends, tees, junctions (with or without doors), reducers, WC connectors, couplers, expansion joints / bellows, cowels, clamps, rubber rings, clean outs etc. fixing at wall/ ceiling/ floor level supported by clamp & hangers etc. in concealed / inside duct / under floor & basement ceiling / external work etc. including chase cutting as required, excavation and back filling in all kind of soils, suspended from floor under false ceiling or embedding the pipes laid under floors / building in 75 mm. around 1:2:4 cement concrete (1 cement : 2 coarse sand : 4 graded stone aggregate 20 mm nominal size) including cost of shuttering for proper completion of the work, breaking and making good the walls and floors etc. after pipes have been duly laid and tested. The rubber ring shall confirm to IS:5382. The Pipes will be supported with threaded G I rods & U clamps with nuts, washers etc on 50x50x5 mm slotted angle. The cost will include all support arrangements. The work includes commissioning of all pipes lines as per drawings and specifications and as directed by engg. in charge at site. | | | | |
| | | a) 110 mm dia (Wall Thickness - 3.2 to 3.8 mm) | Metre | 1700.20 | 536.00 | 9,11,307.20 |
| 18.05 | MR 23 | Providing and fixing uPVC floor trap of self cleaning design including jointing with solvent and embedding in cement concrete all complete. | | | | |
| | | a) 110 mm inlet & 110 mm outlet | Each | 253.00 | 225.00 | 56,925.00 |
| 18.06 | MR 24 | Providing and fixing uPVC inlet fitting (Hopper) maximum with 2 or 3 inlets of 40 to 63 mm OD size fabricated from 110 OD uPVC pipe fixed to uPVC trap jointing with solvent cement joint and set in a cement concrete 1:2:4 mix complete including cost of cutting and making good the walls and floors wherever required. | Each | 210.00 | 334.50 | 70,245.00 |
| 18.07 | MR 25 | Providing and fixing of uPVC Waste pipes 6 kg/cm ² (IS: 4985:2000) including with all fittings e.g. couplings, tees, bends, reducers and screwed adaptors jointing with solvent cement as per Manufacturer's specifications complete including cutting holes or chases in wall and making good the same wherever required. (Waste pipe from fixtures). | | | | |
| | | 40 mm OD | Metre | 292.50 | 268.00 | 78,390.00 |
| 18.08 | MR 26 | Providing and fixing uPVC cleanout plug conforming to IS:14735 – 1999 complete with all fitting, accessories etc. complete. | | | | |
| | | a) 110 mm dia | Each | 107.00 | 177.15 | 18,955.05 |
| | | | | | | - |
| | | Total of sub-head (18.0) (DSR) | | | | 2,23,285.30 |
| | | Total of sub-head (18.0) (Non DSR) | | | | 11,35,822.25 |
| 19.0 | | Water Supply Installations (As per D.S.R.) | | | | |

| S. No. | DSR 2019 | Description | Unit | Quantity | Rate (In Rs) | Amount (In Rs) |
|---------|-----------|--|-------|----------|--------------|----------------|
| 19.01 | 18.7 | Providing and fixing Chlorinated Polyvinyl Chloride (CPVC) pipes having thermal stability for hot and cold water supply including all CPVC plain and brass threaded fittings including fixing the pipe with clamps at 1.00 m spacing. this includes jointing of pipes and fittings with one step CPVC solvent cement and testing of joints complete as per direction of engineer in charge. | | | | |
| | | Internal work -Exposed on Wall | | | | |
| 19.02.1 | 18.7.3 | 25 mm nominal dia pipes | Metre | 181.30 | 369.20 | 66,935.96 |
| 19.02.2 | 18.7.4 | 32 mm nominal dia pipes | Metre | 278.90 | 480.55 | 1,34,025.40 |
| 19.02.3 | 18.7.5 | 40 mm nominal dia pipes | Metre | 385.00 | 648.60 | 2,49,711.00 |
| 19.02.4 | 18.7.6 | 50 mm nominal dia pipes | Metre | 27.00 | 903.50 | 24,394.50 |
| 19.02 | 18.8 | Providing and fixing Chlorinated Polyvinyl Chloride (CPVC) pipes having the thermal stability for hot and cold water supply including all CPVC plain and brass threaded fittings including fixing the pipe with clamps at 1.00 m spacing. this includes jointing of pipes and fittings with one step CPVC solvent cement and the cost of cutting chases and making good the wall same including testing of joints complete as per the direction of engineer incharge | | | | |
| | | Concealed work including cutting chases and making good the wall etc. | | | | |
| 19.02.1 | 18.8.2 | 20 mm nominal dia pipes | Metre | 1073.20 | 478.15 | 5,13,150.58 |
| | 18.8.3 | 25 mm nominal dia pipes | Metre | 515.80 | 561.95 | 2,89,853.81 |
| | 18.8.4 | 32 mm nominal dia pipes | Metre | 284.00 | 679.15 | 1,92,878.60 |
| 19.03 | 18.10 | Providing and fixing G.I. pipes complete with GI fittings and clamps including cutting and making good the walls etc. (internal work) | | | | |
| | | Internal work - Exposed on wall | | | | |
| 19.03.1 | 18.10.3 | 25 mm dia, nominal bore | Metre | 332.00 | 438.00 | 1,45,416.00 |
| 19.03.2 | 18.10.4 | 32 mm dia, nominal bore | Metre | 303.00 | 529.70 | 1,60,499.10 |
| 19.03.3 | 18.10.5 | 40 mm dia, nominal bore | Metre | 150.00 | 639.60 | 95,940.00 |
| 19.03.4 | 18.10.6 | 50 mm dia, nominal bore | Metre | 127.00 | 786.75 | 99,917.25 |
| 19.03.5 | 18.12.7 | 65 mm dia, nominal bore | Metre | 29.00 | 716.00 | 20,764.00 |
| 19.04 | 18.38 | Painting with synthetic enamel paint of approved brand and manufacture to give an even shade | | | | |
| | 18.10.3 | 25 mm dia, nominal bore | Metre | 332.00 | | |
| | 18.10.4 | 32 mm dia, nominal bore | Metre | 303.00 | | |
| | 18.10.5 | 40 mm dia, nominal bore | Metre | 150.00 | | - |
| 19.05 | 18.17 | Providing and fixing gun metal gate valve with CI wheel of approved quality (screwed ends) | | | | |
| 19.05.1 | 18.17.1 | 25mm dia, nominal bore | Each | 71.00 | 497.15 | 35,297.65 |
| 19.05.2 | 18.17.2 | 32 mm dia, nominal bore | Each | 66.00 | 581.25 | 38,362.50 |
| 19.05.3 | 18.17.3 | 40 mm dia, nominal bore | Each | 29.00 | 678.40 | 19,673.60 |
| 19.05.4 | 18.17.4 | 50 mm dia, nominal bore | Each | 4.00 | 869.20 | 3,476.80 |
| 19.06 | 18.19 | Providing and fixing gun metal non- return valve of approved quality (screwed end) | | | | |
| 19.06.1 | 18.19.1.2 | 25 nominal bore | Each | 14.00 | 792.40 | 11,093.60 |
| 19.06.2 | 18.19.2.2 | 32 nominal bore | Each | 6.00 | 1144.05 | 6,864.30 |
| 19.06.3 | 18.19.3.2 | 40 nominal bore | Each | | 2890.70 | - |
| 19.07 | 18.62 | Providing and fixing PTMT Ball cock of approved quality, colour and make complete with Epoxy coated aluminium rod with L.P./ H.P.H.D. plastic ball. | | | | |

| S. No. | DSR 2019 | Description | Unit | Quantity | Rate (In Rs) | Amount (In Rs) |
|---------|-------------|---|-------|----------|--------------|---------------------|
| 19.07.1 | 18.62.3 | 25 mm nominal bore, 152mm long, weighing not less than 440 gms | Each | 14.00 | 394.00 | 5,516.00 |
| 19.07.2 | 18.62.4 (M) | 32mm-40mm nominal bore, 206mm long, weighing not less than 690 gms | Each | 6.00 | 728.50 | 4,371.00 |
| | | Water Supply Internal Work (Non Scheduled Items) | | | | |
| 19.08 | MR 27 | Providing and fixing C.P.V.C. ball valve in C.P.V.C. pipe including jointing of pipes & fittings with one step CPVC solvent cement and testing of joints complete as per direction of Engineer in Charge. (Astral/Prince/Prakash make or equivalent) | | | | |
| 19.08.1 | | 15 mm dia nominal bore | Each | 64.00 | 226.50 | 14,496.00 |
| 19.08.2 | | 20 mm dia nominal bore | Each | 35.00 | 274.65 | 9,612.75 |
| 19.08.3 | | 25 mm dia nominal bore | Each | 60.00 | 375.65 | 22,539.00 |
| 19.08.4 | | 32 mm dia nominal bore | Each | 58.00 | 461.60 | 26,772.80 |
| 19.08.5 | | 40 mm dia nominal bore | Each | 2.00 | 608.75 | 1,217.50 |
| 19.08.6 | | 50 mm dia nominal bore | Each | 1.00 | 691.70 | 691.70 |
| | | Total of sub-head (19.0) (DSR) | | | | 21,18,141.65 |
| | | Total of sub-head (19.0) (Non DSR) | | | | 75,329.75 |
| | | | | | | - |
| 20.0 | | EXTERNAL SEWERAGE SYSTEM | | | | - |
| | | | | | | - |
| | 2.10 | Excavating trenches of required width for pipes, cables, etc including excavation for sockets, and dressing of sides, ramming of bottoms, depth upto 1.5 m, including getting out the excavated soil, and then returning the soil as required, in layers not exceeding 20 cm in depth, including consolidating each deposited layer by ramming, watering, etc. and disposing of surplus excavated soil as directed, within a lead of 50 m : | | | | |
| | 2.10.1 | All kinds of soils | | | | |
| | 2.10.1.2 | Pipes, cables etc. exceeding 80 mm dia. but not exceeding 300 mm dia | Metre | 996.00 | 364.20 | 3,62,743.20 |
| 20.01 | 19.1 | Providing, laying and jointing glazed stoneware pipes class SP-1 with stiff mixture of cement mortar in the proportion of 1:1 (1 cement : 1 fine sand) including testing of joints etc. complete : | | | | - |
| | 19.1.2 | 150 mm diameter | Metre | 906.00 | 500.20 | 4,53,181.20 |
| | 19.1.4 | 250 mm diameter | Metre | 106.00 | 1173.70 | 1,24,412.20 |
| | | | | | | - |
| 20.02 | 19.3 | Providing and laying cement concrete 1:5:10 (1 cement : 5 coarse sand : 10 graded stone aggregate 40 mm nominal size) up to haunches of S.W. pipes including bed concrete as per standard design : | | | | - |
| | 19.3.2 | 150 mm dia S.W pipe | Metre | 445.00 | 629.30 | 2,80,038.50 |
| | 19.3.4 | 250 mm dia S.W pipe | Metre | 53.00 | 861.15 | 45,640.95 |
| 20.03 | 19.2 | Providing and laying cement concrete 1:5:10 (1 cement : 5 coarse sand : 10 graded stone aggregate 40 mm nominal size) all-round S.W. pipes including bed concrete as per standard design : | | | | - |
| | 19.2.2 | 150 mm diameter S.W. pipe | Metre | 445.00 | 999.15 | 4,44,621.75 |
| | 19.2.4 | 250 mm diameter S.W. pipe | Metre | 53.00 | 1346.95 | 71,388.35 |
| | | | | | | - |

| S. No. | DSR 2019 | Description | Unit | Quantity | Rate (In Rs) | Amount (In Rs) |
|--------|----------|--|-------|----------|--------------|----------------|
| 20.04 | 19.7 | Constructing brick masonry manhole in cement mortar 1:4 (1 cement : 4 coarse sand) with R.C.C. top slab with 1:1.5:3 mix (1cement : 1.5 coarse sand (zone-III) : 3 graded stone aggregate 20mm nominal size), foundation concrete 1:4:8 mix (1 cement : 4coarse sand (zone-III) : 8 graded stone aggregate 40 mm nominalsize), inside plastering 12 mm thick with cement mortar 1:3 (1 cement: 3 coarse sand) finished with floating coat of neat cement andmaking channels in cement concrete 1:2:4 (1 cement : 2 coarsesand : 4 graded stone aggregate 20 mm nominal size) finished witha floating coat of neat cement complete as per standard design : | | | | - |
| | 19.7.1 | Inside size 90x80 cm and 45 cm deep including C.I. cover with frame (light duty) 455x610 mm internal dimensions, total weight of cover and frame to be not less than 38 kg (weight of cover 23 kg and weight of frame 15 kg) : | | | | - |
| | 19.7.1.1 | With common burnt clay F.P.S. (non modular) bricks of class designation 7.5 | each | 70.00 | 10905.05 | 7,63,353.50 |
| | 19.7.2 | Inside size 120x90 cm and 90 cm deep including C.I. Cover with frame (medium duty) 500 mm internal diameter, total weight of cover and frame to be not less than 116 kg (weight of cover 58 kg and weight of frame 58 kg) : | | | | |
| | 19.7.2.1 | With common burnt clay F.P.S. (non modular) bricks of class designation 7.5 | each | 15.00 | 22939.65 | 3,44,094.75 |
| | | | | | | - |
| 20.05 | 19.9 | Constructing brick masonry circular type manhole 0.91 m internal dia at bottom and 0.56m dia at top in cement mortar 1:4 (1 cement : 4 coarse sand), inside cement plaster 12 mm thick with cement mortar 1:3 (1 cement : 3 coarse sand) finished with a floating coat of neat cement, foundation concrete 1:3:6 mix (1 cement : 3 coarse sand : 6 graded stone aggregate 40 mm nominal size), and making necessary channel in cement concrete 1:2:4 (1 cement : 2 coarse sand : 4 graded stone aggregate 20 mm nominal size) finished with a floating coat of neat cement, all complete as per standard design : | | | | - |
| | 19.9.1 | 0.91 m deep with S.F.R.C. cover and frame (heavy duty, HD-20 grade designation) 560 mm internal diameter conforming to I.S. 12592, total weight of cover and frame to be not less than 182 kg., fixed in cement concrete 1:2:4 (1 cement : 2 coarse sand : 4 graded stone aggregate 20 mm nominal size) including centering, shuttering all complete. (Excavation, foot rests and 12mm thick cement plaster at the external surface shall be paid for separately) : | | | | - |
| | 19.9.1.1 | With common burnt clay F.P.S. (non modular) bricks of class designation 7.5 | each | 2.00 | 11038.10 | 22,076.20 |
| | | | | | | - |
| 20.06 | 19.8 | Extra for depth for manhole with F.P.S. bricks | | | | - |
| | 19.8.1 | Size 90 X 80 cm | | | | - |
| | 19.8.1.1 | With common burnt clay F.P.S. (non modular) bricks of class designation 7.5 | Metre | 5.00 | 7503.00 | 37,515.00 |
| | 19.8.2 | Size 120x90 cm | | | | |
| | 19.8.2.1 | With common burnt clay F.P.S. (non modular) bricks of class designation 7.5 | Metre | 2.00 | 8994.60 | 17,989.20 |

| S. No. | DSR 2019 | Description | Unit | Quantity | Rate (In Rs) | Amount (In Rs) |
|--------|-----------|---|-------|----------|--------------|----------------|
| 20.07 | 19.10 | Extra depth for circular type manhole 0.91m internal dia (at bottom) beyond 0.91 m to 1.67 m | | | | - |
| | 19.10.1 | With common burnt clay F.P.S. (non modular) bricks of class designation 7.5 | Metre | 1.00 | 6448.40 | 6,448.40 |
| | 19.11 | Constructing brick masonry circular manhole 1.22 m internal dia at bottom and 0.56 m dia at top in cement mortar 1:4 (1 cement :4coarse sand) inside cement plaster 12 mm thick with cement mortar 1:3 (1 cement : 3 coarse sand) finished with a floating coat of neat cement foundation concrete 1:3:6 (1 cement : 3 coarse sand : 6 graded stone aggregate 40 mm nominal size) and making necessary channel in cement concrete 1:2:4 (1 cement : 2 coarse sand : 4 graded stone aggregate 20 mm nominal size) finished with a floating coat of neat cement, all complete as per standard design : | | | | |
| | 19.11.1 | 1.68 m deep with SFRC Cover and frame (heavy duty HD- 20 grade designation) 560 mm internal diameter conforming to I.S. 12592, total weight of cover and frame to be not less than 182 kg. fixed in cement concrete 1:2:4 (1 cement : 2 coarse sand : 4 graded stone aggregate 20 mm nominal size) including centering, shuttering all complete. (Excavation, foot rests and 12 mm thick cement plaster at the external surface shall be paid for separately) : | | | | |
| | 19.11.1.1 | With common burnt clay F.P.S. (non modular) bricks of class designation 7.5 | each | 3.00 | 21235.65 | 63,706.95 |
| | 19.12 | Extra depth for circular type manhole 1.22 m internal dia (at bottom) beyond 1.68 m to 2.29 m : | | | | |
| | 19.12.1 | With common burnt clay F.P.S. (non modular) bricks of class designation 7.5 | Meter | 2.00 | 8368.40 | 16,736.80 |
| | | | | | | - |
| 20.08 | 19.16 | Providing orange colour safety foot rest of minimum 6 mm thick plastic encapsulated as per IS : 10910, on 12 mm dia steel bar conforming to IS : 1786, having minimum cross section as 23 mmx25 mm and over all minimum length 263 mm and width as 165 mm with minimum 112 mm space between protruded legs having 2 mm tread on top surface by ribbing or chequering besides necessary and adequate anchoring projections on tail length on 138 mm as per standard drawing and suitable to with stand the bend test and chemical resistance test as per specifications and having manufacture's permanent identification mark to be visible even after fixing, including fixing in manholes with 30x20x15 cm cement concrete block 1:3:6 (1 cement : 3 coarse sand : 6 graded stone aggregate 20 mm nominal size) complete as per design. | each | 98.00 | 463.05 | 45,378.90 |
| | | | | | | - |
| | 19.19 | Providing and fixing in position pre-cast R.C.C. manhole cover and frame of required shape and approved quality | | | | |
| | 19.19.4 | EHD-35 | | | | |
| | 19.19.4.1 | Circular shape 560 mm internal dia | each | 16.00 | 1859.50 | 29,752.00 |

| S. No. | DSR 2019 | Description | Unit | Quantity | Rate (In Rs) | Amount (In Rs) |
|--------|----------|--|-------|----------|--------------|---------------------|
| 20.09 | 19.4 | Providing and fixing square-mouth S.W. gully trap class SP-1 complete with C.I. grating brick masonry chamber with water tight C.I. cover with frame of 300 x300 mm size (inside) the weight of cover to be not less than 4.50 kg and frame to be not less than 2.70kg as per standard design: | | | | - |
| | 19.4.3.1 | 180x150 mm size P type With FPS bricks | each | 31.00 | 2409.60 | 74,697.60 |
| | | | | | | - |
| 20.10 | 19.21.1 | Making connection of drain or sewer line with existing manhole including breaking into and making good the walls, floors with cement concrete 1:2:4 mix (1cement: 2 coarse sand : 4 graded stone aggregate 20mm nominal size) cement plastered on both sides with cement mortar 1:3 (1cement : 3 coarse sand) finished with a floating coat of neat cement and making necessary channels for the drain etc. complete for pipes 100 to 230mm dia. | each | 3.00 | 623.50 | 1,870.50 |
| | | | | | | |
| | 19.32 | Making soak pit 2.5 m diameter 3.0 metre deep with 45 x 45 cm dry brick honey comb shaft with bricks and S.W. drain pipe 100 mm diameter, 1.8 m long complete as per standard design. | | | | |
| | 19.32.1 | With common burnt clay F.P.S. (non modular) bricks of class designation 7.5 | Each | 14.00 | 25278.75 | 3,53,902.50 |
| | | | | | | |
| | | Total of sub-head (20.0) (DSR) | | | | 35,59,548.45 |
| 21.0 | | External Storm Water Drainage System | | | | |
| | | | | | | |
| | 2.10 | Excavating trenches of required width for pipes, cables, etc including excavation for sockets, and dressing of sides, ramming of bottoms, depth upto 1.5 m, including getting out the excavated soil, and then returning the soil as required, in layers not exceeding 20 cm in depth, including consolidating each deposited layer by ramming, watering, etc. and disposing of surplus excavated soil as directed, within a lead of 50m: | | | | |
| | 2.10.1 | All kinds of soil | | | | |
| | 2.10.1.2 | Pipes, cables etc. exceeding 80 mm dia. but not exceeding 300 mm dia | Metre | 72.00 | 364.20 | 26,222.40 |
| | 2.10.1.3 | Pipes, cables etc. exceeding 300 mm dia but not exceeding 600 mm | Metre | 18.00 | 568.60 | 10,234.80 |
| | | | | | | |
| | 2.13 | Excavating trenches of required width for pipes, cables, etc, including excavation for sockets, depth upto 1.5 m, including getting out the excavated materials, returning the soil as required in layers not exceeding 20 cm in depth, including consolidating each deposited layers by ramming, watering etc., stacking serviceable material for measurements and disposal of unserviceable material as directed, within a lead of 50 m : | | | | |
| | 2.13.1 | Ordinary rock | | | | |
| | 2.13.1.2 | Pipes, cables etc. exceeding 80 mm dia but not exceeding 300 mm dia | Metre | 8.00 | 801.85 | 6,414.80 |
| | 2.13.1.3 | Pipes, cables exceeding 300 mm dia but not exceeding 600 mm dia | Metre | 2.00 | 922.65 | 1,845.30 |
| | | | | | | |

| S. No. | DSR 2019 | Description | Unit | Quantity | Rate (In Rs) | Amount (In Rs) |
|--------|-----------|---|-------|----------|--------------|----------------|
| 21.01 | 19.6 | Providing and laying non-pressure NP2 class (light duty) RCC pipes with collars jointed with stiff mixture of cement mortar in the proportion of 1:2 (1 cement : 2 fine sand) including testing of joints etc. complete. (for storm drainage) | | | | |
| | 19.6.2 | 150 mm dia RCC pipe | Metre | 30.00 | 462.60 | 13,878.00 |
| | 19.6.3 | 250 mm dia RCC pipe | Metre | 25.00 | 754.45 | 18,861.25 |
| | 19.6.4 | 300 mm dia RCC pipe | Metre | 25.00 | 863.65 | 21,591.25 |
| | 19.6.5 | 450 mm dia RCC pipe | Metre | 20.00 | 1392.70 | 27,854.00 |
| 21.02 | 19.3 | Providing and laying cement concrete 1:5:10 (1 cement : 5 coarse sand : 10 graded stone aggregate 40 mm nominal size) up to haunches of S.W. pipes including bed concrete as per standard design : | | | | |
| | 19.3.2 | 150 mm diameter S.W. pipe | Metre | 23.00 | 629.30 | 14,473.90 |
| | 19.3.4 | 250 mm diameter S.W. pipe | Metre | 18.75 | 861.15 | 16,146.56 |
| | 19.3.5 | 300 mm diameter S.W. pipe | Metre | 25.00 | 993.65 | 24,841.25 |
| | analysed | 450 mm diameter S.W. pipe | Metre | 20.00 | 1155.00 | 23,100.00 |
| 21.03 | 19.2 | Providing and laying cement concrete 1:5:10 (1 cement : 5 coarse sand : 10 graded stone aggregate 40 mm nominal size) all-round S.W. pipes including bed concrete as per standard design : | | | | |
| | 19.2.2 | 150 mm diameter S.W. pipe | Metre | 8.00 | 999.15 | 7,993.20 |
| | 19.2.4 | 250 mm diameter S.W. pipe | Metre | 6.25 | 1346.95 | 8,418.44 |
| 21.04 | 19.27 | Constructing brick masonry road gully chamber 50x45x60 cm with bricks in cement mortar 1:4 (1 cement : 4 coarse sand) including 500x450 mm pre-cast R.C.C. horizontal grating with frame complete as per standard design : | | | | |
| | 19.27.1 | With common burnt clay F.P.S. (non modular) bricks of class designation 7.5 | Each | 15.00 | 5209.10 | 78,136.50 |
| 21.05 | 19.19 | Providing and fixing in position pre-cast R.C.C. manhole cover and frame of required shape and approved quality | | | | |
| | 19.19.1 | L D- 2.5 | | | | |
| | 19.19.1.1 | Rectangular shape 600x450mm internal dimensions | Each | 5.00 | 1228.90 | 6,144.50 |
| 21.06 | 9.50 | Providing and fixing hard drawn steel wire fabric 75x25 mm mesh of weight not less than 7.75 Kg per sqm to window frames etc. including 62x19 mm beading of second class teak wood and priming coat with approved steel primer all complete. | Sqm | 5.00 | 1448.35 | 7,241.75 |
| 21.07 | 12.41 | Providing & fixing on wall face unplasticised -Rigid PVC rain water pipes conforming to IS:13592 Type A included jointing with seal ring conforming to IS:5382 leaving 10 mm gap for thermal expansion. (i)Single socketed pipes. | | | | |
| | 12.41.2 | 110 mm diameter | Metre | 30.00 | 305.05 | 9,151.50 |

| S. No. | DSR 2019 | Description | Unit | Quantity | Rate (In Rs) | Amount (In Rs) |
|--------|----------|--|-------|----------|--------------|----------------|
| 21.08 | 23.1 | Boring/drilling bore well of required dia for casing/ strainer pipe, by suitable method prescribed in IS:2800(Part I), including collecting sample from different strata , preparing and submitting strata chart/ bore log, including hire & running charges of all equipments, tools, plants & machineries required for the job, all complete as per direction of Engineer-in-charge, upto 90m depth below ground level. | | | | |
| | 23.1.1 | All types of Soil | | | | |
| | 23.1.1.1 | 300 mm dia | Metre | 180.00 | 512.30 | 92,214.00 |
| 21.09 | 23.3 | Supplying, assembling, lowering and fixing in vertical position in bore well, unplasticized PVC. medium well casing (CM) pipe of required dia, conforming to IS: 12818, including required hire & labour charges, fittings & accessories, all complete, for all depths, as per direction of Engineer-in-charge. | | | | |
| | 23.3.2 | 150mm nominal size dia | Metre | 100.00 | 690.75 | 69,075.00 |
| 21.10 | 23.4 | Supplying, assembling, lowering and fixing in vertical position in bore well, unplasticized PVC. medium well screen(RMS) pipes with ribs, conforming to IS: 12818, including required hire & labour charges, fittings & accessories, all complete, for all depths, as per direction of Engineer-in-charge. | | | | |
| | 23.4.2 | 150 mm nominal size dia | Metre | 80.00 | 746.15 | 59,692.00 |
| 21.11 | 23.5 | Supplying, filling, spreading & levelling stone boulders of size range 5cm to 20cm, in recharge pit, in the required thickness, for all leads & lifts, all complete as per direction of Engineer-in-charge. | cum | 4.00 | 1326.55 | 5,306.20 |
| 21.12 | 23.6 | Supplying, filling, spreading & levelling gravel of size range 5mm to 10mm, in recharge pit, over the existing layer of boulders, in required thickness, for all leads & lifts, all complete as per direction of Engineer-in-charge. | cum | 4.00 | 1326.55 | 5,306.20 |
| 21.13 | 23.7 | Supplying, filling, spreading & levelling coarse sand of size range 1.5mm to 2mm, in recharge pit, in required thickness over gravel layer, for all leads & lifts, all complete as per direction of Engineer-in-charge. | cum | 4.00 | 1326.55 | 5,306.20 |
| 0.01 | 23.9 | Providing and fixing factory made precast RCC perforated drain covers, having concrete of strength not less than M-25, of size 1000 x 450x50 mm, reinforced with 8 mm dia four nos longitudinal & 9 nos cross sectional T.M.T. hoop bars, including providing 50 mm dia perforations @ 100 to 125 mm c/c, including providing edge binding with M.S. flats of size 50 mm x 1.6 mm complete, all as per direction of Engineer-in- charge. | Each | 350.00 | 1210.85 | 4,23,797.50 |

| S. No. | DSR 2019 | Description | Unit | Quantity | Rate (In Rs) | Amount (In Rs) |
|--------|-----------------------|--|-------|----------|--------------|---------------------|
| 21.14 | 23.15 | Providing and fixing Bail plug/ Bottom plug of required dia to the bottom of pipe assembly of tube well as per IS:2800 (part I). | | | | |
| | 23.15.1 | 150 mm dia | each | 6.00 | 227.45 | 1,364.70 |
| 21.14 | Derived from DSR 2019 | Constructing brick masonry open surface drain with bricks of class designation 75 in cement mortar 1:4 (1 cement : 4 fine sand) including 10 cm thick bed concrete 1:5:10 (1 cement: 5 fine sand : 10 graded stone aggregate 40 mm nominal size) and 25 mm thick cement concrete 1:2:4 (1 cement : 2 coarse sand : 4 graded stone aggregate 12.5 mm nominal size) for filling haunches including 12 mm cement plaster 1:4 (1 cement : 4 coarse sand) with a floating coat of neat cement inside the drain, its top and exposed side including disposal of surplus earth complete as per standard design: | | | | |
| | | a) 25 cm drain 30 cm average depth, With F.P.S. bricks | each | 350.00 | 1545.90 | 5,41,065.00 |
| 21.15 | Derived from DSR 2019 | Extra for additional depth for brick masonry open surface drain : a) 25 cm drain 30 cm depth, with common burnt clay F.P.S. (non modular) bricks of class designation 7.5 | Metre | 10.00 | 392.95 | 3,929.50 |
| | | Total of sub-head (21.0) (DSR) | | | | 15,29,605.70 |
| 22 | | EXTERNAL WATER SUPPLY SYSTEM AND PUMPS | | | | |
| | | DISTRIBUTION NETWORK FOR FRESH WATER SUPPLY | | | | |
| 22.01 | 18.12 | Providing and fixing G.I. pipes complete with G.I. fittings including ,trenching and refilling etc. external works | | | | |
| | 18.12.3 | 25mm nominal bore | Metre | 10.00 | 364.55 | 3,645.50 |
| | 18.12.4 | 32mm nominal bore | Metre | 735.00 | 424.70 | 3,12,154.50 |
| | 18.12.5 | 40mm nominal bore | Metre | 75.00 | 558.35 | 41,876.25 |
| | 18.12.6 | 50mm nominal bore | Metre | 195.00 | 565.25 | 1,10,223.75 |
| | 18.12.7 | 65mm nominal bore | Metre | 130.00 | 716.00 | 93,080.00 |
| | 18.12.8 | 80mm nominal bore | Metre | 175.00 | 866.40 | 1,51,620.00 |
| 22.02 | 18.40 | Painting GI pipes and fittings with two coats of anti corrosive bitumastic paint of approved quality | | | | |
| | 18.40.3 | 25 mm dia, nominal bore | Metre | 10.00 | 14.15 | 141.50 |
| | 18.40.4 | 32 mm dia, nominal bore | Metre | 735.00 | 17.05 | 12,531.75 |
| | 18.40.5 | 40 mm dia, nominal bore | Metre | 75.00 | 20.95 | 1,571.25 |
| | 18.40.6 | 50 mm dia, nominal bore | Metre | 195.00 | 23.25 | 4,533.75 |
| | 18.40.7 | 65 mm dia, nominal bore | Metre | 130.00 | 28.95 | 3,763.50 |
| | 18.40.8 | 80mm nominal bore | Metre | 175.00 | 33.60 | 5,880.00 |
| 22.03 | 18.17 | Providing and fixing gun metal gate valve with C.I. wheel of approved quality (screwed end) : external works | | | | |
| | 18.17.1 | 25mm nominal bore | Each | 2.00 | 497.15 | 994.30 |
| | 18.17.2 | 32 mm dia, nominal bore | Each | 23.00 | 581.25 | 13,368.75 |
| | 18.17.4 | 50mm nominal bore | Each | 1.00 | 869.20 | 869.20 |
| | 18.17.5 | 65mm nominal bore | Each | 1.00 | 1488.10 | 1,488.10 |
| | 18.17.6 | 80mm nominal bore | Each | 2.00 | 2217.90 | 4,435.80 |
| 22.04 | | Providing and filling sand of grading zone V or coarser grade all-round the G.I. pipes in external work. | | | | |
| | 18.41.3 | 25mm dia pipe | Metre | 10.00 | 148.40 | 1,484.00 |

| S. No. | DSR 2019 | Description | Unit | Quantity | Rate (In Rs) | Amount (In Rs) |
|--------|-----------|--|-------|----------|--------------|----------------|
| | 18.41.4 | 32mm dia pipe | Metre | 735.00 | 152.25 | 1,11,903.75 |
| | 18.41.5 | 40mm dia pipe | Metre | 75.00 | 170.50 | 12,787.50 |
| | 18.41.6 | 50mm dia pipe | Metre | 195.00 | 159.95 | 31,190.25 |
| | 18.41.7 | 65mm dia pipe | Metre | 130.00 | 252.45 | 32,818.50 |
| | 18.41.8 | 80mm dia pipe | Metre | 175.00 | 260.15 | 45,526.25 |
| 22.05 | 18.59 | Providing and fixing C.I. double acting air valve of approved quality with bolts, nuts, rubber insertions etc. complete (The tail pieces, tapers etc if required will be paid separately) : | | | | |
| | 18.59.1 | 50 mm dia | Each | 1.00 | 5157.00 | 5,157.00 |
| | 18.59.2 | 80 mm dia | Each | 1.00 | 6240.70 | 6,240.70 |
| | 18.59.3 | 100 mm dia | Each | 1.00 | 8193.10 | 8,193.10 |
| 22.06 | 18.31.1 | Providing & Fixing C.I.sluiice valve(with cap) complete with bolts,nuts,rubber insertions etc.(the tail pieces if required will be paid separately) | | | | |
| i) | 18.31.1.1 | 100 mm dia.pipe Class I | Each | 1.00 | 3977.60 | 3,977.60 |
| ii) | 18.32.1 | Constructing masonry chamber 30x30x50 cm,inside with 75 class designation brick work in cement mortar 1:4 (1 cement:4 coarse sand) for stop cock complete with C.I. surface box 100x100x75mm (inside) with locking arrangement and RCC top slab 1:2:4 mix (1 cement : 2 coarse sand: 4 graded stone aggregate 20mm nominal size) necessary excavation foundation concrete 1:5:10 (1 cement:5 fine sand : 10 graded stone aggregate 40 mm nominal size) and inside plastering with cement mortar 1:3 (1 cement : 3 coarse sand) 12 mm thick finished with a floating coat of neat cement complete as per standard design. | Each | 23.00 | 1582.45 | 36,396.35 |
| 22.07 | 18.33 | Constructing masonry Chamber 60x60x75 cm inside, in brick work in cement mortar 1:4 (1 cement : 4 coarse sand) for sluiice valve, with C.I. surface box 100mm top diameter, 160 mm bottom diameter and 180 mm deep (inside) with chained lid and RCC top slab 1:2:4 mix (1 cement : 2 coarse sand : 4 graded stone aggregate 20mm nominal size) , i/c necessary excavation, foundation concrete 1:5:10 (1 cement : 5 fine sand : 10 graded stone aggregate 40 mm nominal size) and inside plastering with cement mortar 1:3 (1 cement : 3 coarse sand) 12 mm thick, finished with a floating coat of neat cement complete as per standard design : | | | | |
| | 18.33.1 | With common burnt clay F.P.S.(non modular) bricks of class designation 7.5 | Each | 1.00 | 9288.40 | 9,288.40 |

| S. No. | DSR 2019 | Description | Unit | Quantity | Rate (In Rs) | Amount (In Rs) |
|--------|---------------------------|---|-------|----------|--------------|---------------------|
| 22.08 | 18 | Constructing masonry Chamber 90x90x100 cm inside, in brick work in cement mortar 1:4 (1 cement : 4 coarse sand) for sluice valve, with C.I. surface box 100 mm top diameter, 160 mm bottom diameter and 180 mm deep (inside) with chained lid and RCC top slab 1:2:4 mix (1 cement : 2 coarse sand : 4 graded stone aggregate 20 mm nominal size), i/c necessary excavation, foundation concrete 1:5:10 (1 cement : 5 fine sand : 10 graded stone aggregate 40 mm nominal size) and inside plastering with cement mortar 1:3 (1 cement : 3 coarse sand) 12 mm thick, finished with a floating coat of neat cement complete as per standard design : 18.34.1 With common burnt clay F. | | | | |
| | 18.34.1 | With common burnt clay F.P.S.(non modular) bricks of class designation 7.5 | Each | 2.00 | 16134.15 | 32,268.30 |
| 22.09 | 18.13 | Making connection of G.I. distribution branch with G.I. main of following sizes by providing and fixing tee, including cutting and threading the pipe etc. complete : | | | | |
| | 18.13.2 | 50 to 80 mm nominal bore | Item | 8.00 | 1432.75 | 11,462.00 |
| 22.10 | ELECT. DSR 2018/ 16.11.1 | BUTTERFLY VALVE (MANUAL) with C I body SS disc nitrile sheet & O - ring & PN 16 pressure rating as specified. | | | | |
| | 16.11.1.6 | 65 nominal bore | Each | 3.00 | 2837.00 | 8,511.00 |
| | 16.11.1.5 | 80 nominal bore | Each | 3.00 | 3015.00 | 9,045.00 |
| 22.11 | ELECT. DSR 2018 / 16.11.2 | NON - RETURN VALVE with dual plate of C I body SS plates vulcanized NBR seal flanged end & PN 16 pressure rating as specified. | | | | |
| | 16.11.2.2 | 150 nominal bore | Each | 1.00 | 7171.00 | 7,171.00 |
| | 16.11.2.4 | 100 nominal bore | Each | 1.00 | 4581.00 | 4,581.00 |
| | 16.11.2.5 | 80 nominal bore | Each | 2.00 | 3139.00 | 6,278.00 |
| 22.12 | ELECT. DSR 2018 / 14.13 | Providing and fixing GI pipes medium class conforming to IS 1239 with GI fittings including cutting hole chase painted with primer, two coats of enamel paints etc | | | | |
| | 14.13.3 | 100 mm dia, NB | Metre | 5.00 | 1113.00 | 5,565.00 |
| | 14.13.4 | 150 mm dia, NB | Metre | 5.00 | 1687.00 | 8,435.00 |
| | | Total of sub-head (22.0) (DSR) | | | | 11,60,457.60 |
| 23.0 | | Bore Well Installations (As per D.S.R) | | | | |
| 23.01 | 23.1 | Boring/drilling bore well of required dia for casing/ strainer pipe, by suitable method prescribed in IS: 2800 (part I), including collecting samples from different strata, preparing and submitting strata chart/ bore log, including hire & running charges of all equipments, tools, plants & machineries required for the job, all complete as per direction of Engineer -in-charge, upto 90 metre depth below ground level | | | | |
| | 23.1.1 | All types of soil | | | | |
| | 23.1.1.1 | 300 mm dia | metre | 50.00 | 512.30 | 25,615.00 |
| | 23.1.2 | Rocky strata including Boulders | | | | |
| | 23.1.2.1 | 300 mm dia | metre | 15.00 | 1223.20 | 18,348.00 |

| S. No. | DSR 2019 | Description | Unit | Quantity | Rate (In Rs) | Amount (In Rs) |
|--------|----------|---|-------|----------|--------------|-----------------------|
| | 23.3 | Supplying, assembling, lowering and fixing in vertical position in bore well, unplasticized PVC medium well casing (CM) pipe of required dia, conforming to IS: 12818, including required hire and labour charges, fittings & accessories etc. all complete, for all depths, as per direction of Engineer -in-charge. | Meter | | | |
| | 23.3.3 | 200mm nominal dia | Meter | 40.00 | 1066.05 | 42,642.00 |
| 23.02 | 23.4 | Supplying, assembling, lowering and fixing in vertical position in bore well unplasticized PVC medium well screen (RMS) pipes with ribs, conforming to IS: 12818, including hire & labour charges, fittings & accessories etc. all complete, for all depths, as per direction of Engineer-in-charge. | | | | |
| | 23.4.3 | 200 mm nominal size dia | metre | 20.00 | 1135.80 | 22,716.00 |
| 23.03 | 23.8 | Gravel packing in tubewell construction in accordance with IS: 4097, including providing gravel fine/ medium/ coarse, in required grading & sizes as per actual requirement, all complete as per direction of Engineer-in-charge. | cum | 4.00 | 1497.70 | 5,990.80 |
| 23.04 | 23.12 | Development of tube well in accordance with IS : 2800 (part I) and IS: 11189, to establish maximum rate of usable water yield without sand content (beyond permissible limit), with required capacity air compressor, running the compressor for required time till well is fully developed, measuring yield of well by "V" notch method or any other approved method, measuring static level & draw down etc. by step draw down method, collecting water samples & getting tested in approved laboratory, i/c disinfection of tubewell, all complete, including hire & labour charges of air compressor, tools & accessories etc., all as per requirement and direction of Engineer-in-charge. | hour | 36.00 | 857.60 | 30,873.60 |
| 23.05 | 23.13 | Providing and fixing suitable size threaded mild steel cap or spot welded plate to the top of bore well housing/ casing pipe, removable as per requirement, all complete for borewell of: | | | | |
| | 23.13.3 | 200 mm nominal size dia | Each | 1.00 | 280.95 | 280.95 |
| 23.06 | 23.14 | Providing and fixing M.S. clamp of required dia to the top of casing/ housing pipe of tubewell as per IS: 2800 (part I), including necessary bolts & nuts of required size complete. | | | | |
| | 23.14.3 | 200 mm clamp | Each | 2.00 | 1691.15 | 3,382.30 |
| 23.07 | 23.15 | Providing and fixing Bail plug/ Bottom plug of required dia to the bottom of pipe assembly of tubewell as per IS:2800 (part I). | | | | |
| | 23.15.3 | 200 mm dia | Each | 1.00 | 307.75 | 307.75 |
| | | Total of sub-head (23.0) (DSR) | | | | 1,50,156.40 |
| | | TOTAL AMOUNT (DSR) | | | | 1,12,04,824.56 |
| | | TOTAL AMOUNT (NON DSR) | | | | 16,82,734.73 |

Signature of Bidder

| S. No. | DSR 2019 | Description | Unit | Quantity | Rate (In Rs) | Amount (In Rs) |
|---------------------------------|------------------|---|-------|----------|--------------|--------------------|
| ****Electrical works**** | | | | | | |
| FIRE FIGHTING WORKS | | | | | | |
| 24.0 | DSR-18/19 | PIPING & VALVES | | | | |
| 24.01 | 7 | Providing, laying, testing & commissioning of 'C' class heavy duty MS pipe conforming to IS 3589/IS 1239 including Welding, fittings like elbows, tees, flanges ,tapers, nuts bolts, gaskets etc. and fixing the pipe on the wall/ceiling with suitable clamp/support frame and painting with two or more coats of synthetic enamel paint of required shade complete as required : | | | | |
| | 7.1 | 25 mm dia. | Metre | 22.00 | 471.00 | 10,362.00 |
| | 7.5 | 65 mm dia. | Metre | 76.00 | 1004.00 | 76,304.00 |
| | 7.6 | 80 mm dia. | Metre | 230.00 | 1122.00 | 2,58,060.00 |
| | 7.7 | 100mm dia | Metre | 35.00 | 1499.00 | 52,465.00 |
| 24.02 | 14 | Providing, installation, testing and commissioning of non-return valve of following sizes conforming to IS:5312 complete with rubber gasket, GI bolts, nuts washers etc.as required : | | | | |
| | 14.5 | 80mm dia | Nos | 3.00 | 7539.00 | 22,617.00 |
| 24.03 | 18.17 | Providing and fixing gun metal gate valve with C.I. wheel of approved quality (screwed end) : | | | | |
| | 18.17.1 | 25 mm dia. | Nos | 22.00 | 497.15 | 10,937.30 |
| 24.04 | 11 | Supplying, fixing, testing and commissioning of butterfly valve of PN 1.6 rating with bronze/gunmetal seat duly ISI marked complete with nuts, bolts, washers, gaskets conforming to IS 13095 of following sizes as required : | | | | |
| | 11.5 | 100 mm dia. | Nos | 6.00 | 6454.00 | 38,724.00 |
| 24.05 | MR | Providing and fixing 150 mm dial diameter size Pressure gauge (0-15 Kg/Cm2) complete with shut off valve duly calibrated before installation complete as required & as per enclosed specification. | Nos | 3.00 | 682.00 | 2,046.00 |
| 24.06 | 15 | Providing, installation, testing and commissioning of stainless steel Y-strainer fabricated out of 1.6 mm thick stainless steel, Grade 304, sheet with 3 mm dia holes with stainless steel flange. | | | | |
| | 15.2 | 100mm dia | Each | 3.00 | 6450.00 | 19,350.00 |
| | | Total of sub-head (24.0) (DSR) | | | | 4,88,819.30 |
| | | Total of sub-head (24.0) (NON DSR) | | | | 2,046.00 |
| 25.0 | | FIRE HYDRANT ACCESSORIES | | | | |
| 25.01 | 17 | Supplying and fixing first-aid Hose Reel with MS construction spray painted in post office red, conforming to IS 884 complete with the following as required. 20 mm nominal internal dia water hose thermoplastic (Textile reinforced) type -2 as per IS: 12585 20 mm nominal internal dia gun metal globe valve & nozzle. Drum and brackets for fixing the equipments on wall. Connections from riser with 25 mm dia stop gun metal valve & M.S. Pipe and socket. | | | | |
| | 17.1 | 30m | Nos | 22.00 | 8413.00 | 1,85,086.00 |
| | | Total of sub-head (25.0) (DSR) | | | | 1,85,086.00 |
| 26.0 | | FIRE EXTINGUISHERS & MISC. ITEMS | | | | |
| 26.01 | MR | Providing and fixing Carbon-di-oxide fire extinguishers consisting of welded M.S cylindrical body, squeeze lever discharge valve fitted with internal discharge tube, 30cms long high pressure discharge hose, discharge nozzle, suspension bracket, confirming to IS : 15683 finished externally with red enamel paint and fixed to wall with brackets with rawl plug/dash fasteners complete with internal charge. Capacity 4.5 kg, ISI Marked.(Contractor should submit test certificate form manufacturer along with serial number of every extinguishers supplied.) | Nos | 2.00 | 6087.00 | 12,174.00 |
| 26.02 | MR | Providing and fixing (ABC Dry Chemical Powder) type Fire Extinguisher of Capacity 6 kg Confirms to IS 15683, bearing ISI mark complete with brass forged squeeze grip type valve fitted with pressure gauge , pressurize with dry Nitrogen gas filled, with discharge nozzle with wall mounting bracket (rubber gripped) complete with internal charges. (Contractor should submit test certificate form manufacturer along with serial number of every extinguishers supplied. | Nos | 46.00 | 2274.00 | 1,04,604.00 |

| S. No. | DSR 2019 | Description | Unit | Quantity | Rate (In Rs) | Amount (In Rs) |
|--------|----------|--|-------|----------|--------------|--------------------|
| 26.03 | MR | Providing and fixing water Carbon-di-oxide (ISI marked) extinguishers including all accessories as per IS specification with wall bracket with rawl plug complete as reqd.(Contractor should submit test certificate form manufacturer along with serial number of every extinguishers supplied.) | Nos | 2.00 | 3582.00 | 7,164.00 |
| | | Capacity 9 Litres | | | | |
| | | Total of sub-head (26.0) (Non DSR) | | | | 1,23,942.00 |
| 27.0 | | FIRE PUMPS & ACCESSORIES | | | | |
| 27.01 | MR | Supplying, installation, testing and commissioning of electric driven terrace pump suitable for automatic operation and consisting of following, complete in all respects, as required: (Terrace Pump) | | | | |
| | | (a) Horizontal type, multistage, centrifugal, split casing pump of cast iron body & bronze impeller with stainless steel shaft, mechanical confirming to IS : 1520 | | | | |
| | | b) Suitable HP squirell cage induction motor TEFC type suitable for operation on 415 volts, 3 phase, 50 Hz, AC supply with IP55 class of protection for enclosure, horizontal foot mounted type with Class-'F' insulation, conforming to IS-325. | | | | |
| | | (c) M.S.fabricated common base plate, coupling, coupling guard, foundation bolts etc.as required. | | | | |
| | | (d) Suitable cement concrete foundation duly plastered and with anti vibration pads. | | | | |
| | | 450 lpm at 35 m Head | Set | 3.00 | 85291.00 | 2,55,873.00 |
| 27.02 | MR | Providing and fixing rubber expansion joint (to provide relief from stresses at pipe flanges) as per specification of the manufacturers and direction of Engineer in chief PN-16 rating | | | | |
| | | (a) 100 mm dia | Nos | 3.00 | 560.00 | 1,680.00 |
| 27.03 | 20 | Supplying and fixing air vessel made of 250 mm dia, 8 mm thick MS sheet, 1200 mm in height with air release valve on top and flanged connection to riser, drain arrangement with 25 mm dia gun metal wheel valve with required accessories, pressure gauge and painting with synthetic enamel paint of approved shade as required. | Nos | 3.00 | 18009.00 | 54,027.00 |
| 27.04 | MR | "Providing, fixing, testing and commissioning of control panel for Terrace Booster pumps. Incoming: MCCB 35A 1 set of Phase indicating lamps, 1 set of 35A AI bus bars, 1No Ammeter, 1No Voltmeter with phase selector switch Feeder for Booster Pumps - 1 No. 1 No. 32A TP MCCB without releases. DOL starter with over load relay, single phase preventor and indicating lamps with ON/OFF push buttons. 1 No. Automanual selector switch. Suitable for booster pumps" | Nos | 3.00 | 34429.00 | 1,03,287.00 |
| | | Total of sub-head (27.0) (DSR) | | | | 3,09,900.00 |
| | | Total of sub-head (27.0) (Non DSR) | | | | 1,04,967.00 |
| | | ELECTRICAL WORKS (Internal) | | | | |
| 28.0 | | Internal Wiring | | | | |
| | | Point wiring in PVC conduit, with modular type switch :- | | | | |
| 28.01 | 1.10 | Wiring for light point/ fan point/ exhaust fan point/ call bell point with 1.5 sq.mm FRLS PVC insulated copper conductor single core cable in surface / recessed medium class PVC conduit, with modular switch, modular plate, suitable GI box and earthing the point with 1.5 sq.mm FRLS PVC insulated copper conductor single core cable etc. as required. | | | | |
| | 1.10.1 | Group A | Point | 1337.00 | 717.00 | 9,58,629.00 |
| | 1.10.2 | Group B | Point | 78.00 | 783.00 | 61,074.00 |
| | 1.10.3 | Group C | Point | 484.00 | 990.00 | 4,79,160.00 |
| 28.02 | 1.55 | Wiring for group controlled (looped) light point/ fan point/ exhaust fan point/ call bell point (without independent switch etc) with 1.5 sq.mm FRLS PVC insulated copper conductor single core cable in surface / recessed PVC conduit, and earthing the point with 1.5 sq.mm FRLS PVC insulated copper conductor single core cable etc as required. | | | | |
| | | (Note: To be provided in class rooms in school bldg./ common areas/ toilets/ corridors etc.) | | | | |
| | 1.55.1 | Group A | Point | 221.00 | 463.00 | 1,02,323.00 |
| | 1.55.2 | Group B | Point | 6.00 | 508.00 | 3,048.00 |
| | 1.55.3 | Group C | Point | 239.00 | 555.00 | 1,32,645.00 |

| S. No. | DSR 2019 | Description | Unit | Quantity | Rate (In Rs) | Amount (In Rs) |
|--------|----------|--|-------|----------|--------------|---------------------|
| 28.03 | 1.11 | Wiring for twin control light point with 1.5 sq.mm FRLS PVC insulated copper conductor single core cable in surface / recessed medium class PVC conduit, 2 way modular switch, modular plate, suitable GI box and earthing the point with 1.5 sq.mm FRLS PVC insulated copper conductor single core cable etc. as required. | Point | 40.00 | 1057.00 | 42,280.00 |
| | | Power plug wiring in PVC conduit (2 x 4 Sq.Mm.) :- | | | | |
| 28.04 | 1.12 | Wiring for light/ power plug with 2X4 sq. mm FRLS PVC insulated copper conductor single core cable in surface/ recessed medium class PVC conduit alongwith 1 No. 4 sq. mm FRLS PVC insulated copper conductor single core cable for loop earthing as required. | Metre | 4476.00 | 200.00 | 8,95,200.00 |
| | | Circuit / Sub main wiring in PVC conduit :- | | | | |
| 28.05 | 1.14 | Wiring for circuit/ submain wiring alongwith earth wire with the following sizes of FRLS PVC insulated copper conductor, single core cable in surface/ recessed medium class PVC conduit as required. | | | | |
| | 1.14.1 | 2 X 1.5 sq. mm + 1 X 1.5 sq. mm earth wire. | Metre | 4527.00 | 146.00 | 6,60,942.00 |
| | 1.14.2 | 2 X 2.5 sq. mm + 1 X 2.5 sq. mm earth wire. | Metre | 5123.00 | 167.00 | 8,55,541.00 |
| | 1.14.4 | 2 x 6 sq.mm. + 1 x 6 sq.mm. Earth wire | Metre | 905.00 | 249.00 | 2,25,345.00 |
| | 1.14.5 | 2 x 10 sq.mm. + 1 x 6 sq.mm. Earth wire | Metre | 980.00 | 328.00 | 3,21,440.00 |
| | 1.14.10 | 4 x 10 sq.mm. + 2 x 6 sq.mm. Earth wire | Metre | 1190.00 | 543.00 | 6,46,170.00 |
| | 1.14.11 | 4 x 16 sq.mm. + 2 x 6 sq.mm. Earth wire | Metre | 25.00 | 752.00 | 18,800.00 |
| | | S/F light plug point Modular Type Accessories :- | | | | |
| 28.06 | 1.31 | Supplying and fixing suitable size GI box with modular plate and cover in front on surface or in recess, including providing and fixing 3 pin 5/6 A modular socket outlet and 5/6 A modular switch, connections etc. as required. | Each | 894.00 | 401.00 | 3,58,494.00 |
| | | S/F power plug point modular Type Accessories :- | | | | |
| 28.07 | 1.32 | Supplying and fixing suitable size GI box with modular plate and cover in front on surface or in recess, including providing and fixing 6 pin 5/6 & 15/16 A modular socket outlet and 15/16 A modular switch, connections etc. as required. | Each | 375.00 | 495.00 | 1,85,625.00 |
| 28.08 | 2.18 | Supplying and fixing 20 A, 240 V, SPN Industrial type socket outlet, with 2 pole and earth, metal enclosed plug top alongwith 20 A "C" curve, SP, MCB, in sheet steel enclosure, on surface or in recess, with chained metal cover for the socket out let and complete with connections, testing and commissioning etc. as required. | Each | 32.00 | 1232.00 | 39,424.00 |
| 28.09 | 1.38 | Supplying and fixing call bell/ buzzer suitable for single phase, 230 V, complete as required. | Each | 32 | 92.00 | 2,944.00 |
| 28.10 | MR | Supplying and fixing suitable size GI box with modular plate and cover in front on surface or in recess, including providing and fixing 2 nos. of 3 pin 5/6 A modular socket outlet and 2 nos. of 5/6 A modular switch, connections etc. as required. | Each | 49 | 763.00 | 37,387.00 |
| | | Total of sub-head (28.0) (DSR) | | | | 59,89,084.00 |
| | | Total of sub-head (28.0) (NON DSR) | | | | 37,387.00 |
| 29.0 | | Distribution Boards & MCB'S | | | | |
| 29.01 | 2.10 | Supplying and fixing 5 A to 32 A rating, 240/415 V, 10 kA, "C" curve , miniature circuit breaker suitable for inductive load of following poles in the existing MCB DB complete with connections, testing and commissioning etc. as Required. | | | | |
| | 2.10.1 | Single pole | Each | 1046.00 | 199.00 | 2,08,154.00 |
| | 2.10.5 | Triple pole and neutral | Each | 12.00 | 1092.00 | 13,104.00 |
| | | | | | | - |
| 29.02 | 2.11 | Supplying and fixing single pole blanking plate in the existing MCB DB complete etc. as required. | Each | 168.00 | 8.00 | 1,344.00 |
| 29.03 | 2.4 | Supplying and Fixing Following way, Horizontal Type Three Pole and Neutral, Sheet Steel, MCB Distribution Board, 415 V , on surface/ recess, complete with tinned copper bus bar, neutral bus bar, earth bar, din bar, interconnections, powder painted including earthing etc. as required. (But without MCB/RCCB/Isolator). | | | | - |
| | 2.4.2 | 6 Way (4 + 18), Double Door | Each | 13.00 | 3693.00 | 48,009.00 |
| | 2.4.3 | 8 Way (4 + 24), Double Door | Each | 22.00 | 4601.00 | 1,01,222.00 |
| | | | | | | - |
| 29.04 | 2.3 | Supplying and fixing following way, Single Pole and Neutral , sheet steel, MCB distribution board, 240 V, on surface/ recess, complete with tinned copper bus bar, neutral bus bar, earth bar, din bar, interconnections, powder painted including earthing etc. as required. (But without MCB/RCCB/Isolator). | | | | - |

| S. No. | DSR 2019 | Description | Unit | Quantity | Rate (In Rs) | Amount (In Rs) |
|--------|----------|---|-------|----------|--------------|--------------------|
| | 2.3.1 | 6 Way Double door. | Each | 2.00 | 1661.00 | 3,322.00 |
| | 2.3.2 | 8 Way Double door. | Each | 5.00 | 1760.00 | 8,800.00 |
| | 2.3.3 | 12 Way Double door. | Each | 28.00 | 2053.00 | 57,484.00 |
| | | | | | | - |
| | | S/F DP MCB Isolator | | | | - |
| 29.05 | 2.12 | Supplying and fixing following Rating, Double pole, 240 V, isolator in the existing MCB DB complete with connections, testing and commissioning etc. as Required. | | | | - |
| | 2.12.1 | 40 Amps | Each | 5.00 | 339.00 | 1,695.00 |
| | 2.14.3 | 63 Amps | Each | 30.00 | 385.00 | 11,550.00 |
| | | | | | | - |
| | | S/F 4P MCB Isolator | | | | - |
| 29.06 | 2.13 | Supplying and fixing following rating, four pole, 415 V, isolator in the existing MCB DB complete with connections, testing and commissioning etc. as Required. | | | | - |
| | 2.13.2 | 63 Amps | Each | 17.00 | 839.00 | 14,263.00 |
| | 2.13.3 | 100 Amps | Each | 17.00 | 1047.00 | 17,799.00 |
| | | | | | | - |
| | | S/F DP (RCCB) | | | | - |
| 29.07 | 2.14 | Supplying and fixing following rating, double pole, (single phase and neutral), 240 V, residual current circuit breaker (RCCB), having a sensitivity current 30 mA in the existing MCB DB complete with connections, testing and commissioning etc. as Required. | | | | - |
| | 2.14.2 | 40 Amps | Each | 2.00 | 2095.00 | 4,190.00 |
| | 2.14.3 | 63 Amps | Each | 30.00 | 2640.00 | 79,200.00 |
| | 2.15 | Supplying and fixing following rating, Four pole, (Three phase and neutral), 415 V, residual current circuit breaker (RCCB), having a sensitivity current 30 mA in the existing MCB DB complete with connections, testing and commissioning etc. as required. | | | | |
| | 2.15.2 | 40 Amps | Each | 1.00 | 2626.00 | 2,626.00 |
| | 2.15.3 | 63 Amps | Each | 34.00 | 2777.00 | 94,418.00 |
| 29.08 | 2.5 | Supplying and fixing of following ways surface/ recess mounting, vertical type, 415 V, TPN MCB distribution board of sheet steel, dust protected, duly powder painted, inclusive of 200 A tinned copper bus bar, common neutral link, earth bar, din bar for mounting MCBs (but without MCBs and incomer) as required . (Note : Vertical type MCB TPDB is normally used where 3 phase outlets are required.) | | | | |
| | 2.5.1 | 4 way (4 + 12), Double door | Each | 3.00 | 5651.00 | 16,953.00 |
| 29.09 | MR | Supplying and fixing following rating, Single/ double/ three pole, 230/ 415 volts, MCB "C" curve in the existing MCB DB complete with connections, testing and commissioning etc. as required. | | | | |
| | | 63 amps FP MCB | Each | 13.00 | 1475.00 | 19,175.00 |
| | | | | | | |
| | | Total of sub-head (29.0) (DSR) | | | | 6,84,133.00 |
| | | Total of sub-head (29.0) (Non-DSR) | | | | 19,175.00 |
| 30.0 | | Telephone, Television & Data System (Socket,Wiring & Conduiting Only) | | | | |
| | | | | | | |
| | | S/F Modular Boxes, Base & Cover Plate :- | | | | |
| 30.01 | 1.27 | Supplying and Fixing Following Size/ Modules, GI Box Alongwith Modular Base & Cover Plate for Modular Switches in Recess etc. as Required. | | | | |
| | 1.27.1 | 1 or 2 Module (75 mm x 75 mm) | Each | 167.00 | 243.00 | 40,581.00 |
| | 1.27.2 | 3 Module (100mmX75mm) | Each | 40.00 | 267.00 | 10,680.00 |
| | | | | | | |
| | | S/F Modular Type Switch / Socket :- | | | | |
| 30.02 | 1.24 | Supplying and Fixing Following Modular Switch/ Socket on The Existing Modular plate & Switch Box including connections But Excluding Modular Plate etc. as required. | | | | |
| | 31.02.01 | 1.24.6 Telephone Socket outlet. | Each | 54.00 | 119.00 | 6,426.00 |
| | 31.02.02 | 1.24.7 TV Antenna socket outlet. | Each | 41.00 | 119.00 | 4,879.00 |
| | 31.02.03 | 1.24.8 Bell push | Each | 8.00 | 126.00 | 1,008.00 |
| 30.03 | 1.21 | Supplying and fixing of following sizes of medium class PVC conduit along with accessories in surface/recess including cutting the wall and making good the same in case of recessed conduit as required. | | | | |
| | 31.03.01 | 1.21.1 20 mm. | Metre | 3030.00 | 84.00 | 2,54,520.00 |
| | 31.03.02 | 1.21.2 25 mm. | Metre | 455.00 | 90.00 | 40,950.00 |
| 30.04 | 1.18 | Supplying and drawing following pair 0.5 mm dia FRLS PVC insulated annealed copper conductor, Unarmored Telephone cable in the existing surface/ recessed steel/ PVC conduit as required. | | | | |
| | 1.18.2 | 2 Pair | Metre | 1195.00 | 20.00 | 23,900.00 |
| 30.05 | 1.19 | Supplying and drawing co-axial TV cable RG-6 grade, 0.7 mm solid copper conductor PE insulated, shielded with fine tinned copper braid and protected with PVC sheath in the existing surface/ recessed steel/ PVC conduit as required. | Metre | 720.00 | 33.00 | 23,760.00 |

| S. No. | DSR 2019 | Description | Unit | Quantity | Rate (In Rs) | Amount (In Rs) |
|--------|----------|--|-------|----------|--------------|--------------------|
| 30.06 | 1.53 | Supplying and drawing of UTP 4 pair CAT 6 LAN Cable in the existing surface/ recessed Steel/ PVC conduit as required. | | | | |
| | 1.53.1 | 1 run of cable | Metre | 2100.00 | 49.00 | 1,02,900.00 |
| 30.07 | 1.38 | Supplying and fixing call bell/ buzzer suitable for single phase, 230 V, complete as require | Each | 4.00 | 92.00 | 368.00 |
| 30.07 | MR 1 | SITC Modular Type Computer jack RJ 45 ISI mark 1 Module on existing Mounting plate and box Complete. | Each | 84.00 | 200.00 | 16,800.00 |
| | | Total of sub-head (30.0) (DSR) | | | | 5,09,972.00 |
| | | Total of sub-head (30.0) (Non DSR) | | | | 16,800.00 |
| 31.0 | | Internal Lighting Fixtures & Fans | | | | |
| 31.01 | MR 2 | Supply of 20 Watt LED light Wall Mounted BRACKET light fitting Suitable for 220 volts Single Phase A C Supply complete with all accessories as required. | Each | 1.00 | 800.00 | 800.00 |
| 31.02 | MR 3 | Supply of Surface Mounted Energy Efficient, LED Luminaires 12W LED DOWN LIGHT (Round) Suitable for 220v Single Phase Supply complete with driver circuit including making connections etc.as required. (Technical Data - System power 12W, CRI ≥80, Power Factor ≥0.95, System Luminous Efficacy ≥94). | Each | 78.00 | 745.00 | 58,110.00 |
| 31.03 | MR 4 | Supply of Surface Mounted Energy Efficient, LED Luminaires 15W LED DOWN LIGHT (Round) Suitable for 220v Single Phase Supply complete with driver circuit including making connections etc.as required. (Technical Data - System power 15W, CRI ≥80, Power Factor ≥0.95, System Luminous Efficacy ≥94). | Each | 35.00 | 800.00 | 28,000.00 |
| 31.04 | MR 5 | Supplying of brass batten/ angle holder including 20 w LED Lamp, connection etc. as required. | Each | 501.00 | 300.00 | 1,50,300.00 |
| 31.04 | MR 5 | Supply, of Linear & Compact 10W Mirror Light with Decorative Grey Caps, Polycarbonate Body & Ribbed Opal Diffuser. (Technical Data - System power 10W, CRI ≥80, Power Factor ≥0.95, System Luminous Efficacy ≥100) | Each | 1.00 | 275.00 | 275.00 |
| 31.05 | MR 6 | Supply of LED Luminaires BATTEN 40W LED Tube Light of Box Type prewired Indoor Luminaire with Energy Efficient Electronic Ballast, with End Caps Complete as Required. (Technical Data - System power 40W, CRI ≥80, Power Factor ≥0.95, System Luminous Efficacy ≥95) | Each | 310.00 | 905.00 | 2,80,550.00 |
| 31.06 | MR 7 | Supply of LED Luminaires BATTEN 20W LED Tube Light of Box Type Prewired Indoor Luminaire with Energy Efficient Electronic Ballast, with End Caps Complete as Required.(Technical Data - System power 20W, CRI ≥80, Power Factor ≥0.95, System Luminous Efficacy ≥100) | Each | 768.00 | 383.00 | 2,94,144.00 |
| 31.07 | MR 8 | Supplying and fixing of Bulk Head with 10 Watt LED lamp fitting Suitable for 230 volts Single Phase A C Supply complete with all accessories as required. | Each | 18.00 | 1203.00 | 21,654.00 |
| | | SUPPLY FANS & EXHAUST FANS | | | | |
| 31.07 | MR 8 | Supply, of following size sweep, BEE 5 star rated, white colour ceiling fan with all accessories i.e. 3 nos. blades, 30 cm long down rod, 2 nos. canopies, shackle kit, safety rope, copper winding, safety pin,nut bolts, washers, , suitable for 230 V, 50 Hz, single phase AC Supply, earthing etc. complete as required. | | | | |
| | | (a) 1200 mm Sweep | Each | 534.00 | 1790.00 | 9,55,860.00 |
| 31.08 | MR9 | Supply of following sweep heavy duty metal body exhaust fan/wall fan/ fresh air (ventilating) plastic body fan with guard suitable operation on single phase 230 V, 50Hz. AC Supply, with lowers / shutters in the existing opening. (Crompton - Trans Air 300/200mm/Approved Equivalent in Usha/Havells/Bajaj) | | | | |
| | | (a) 200 mm sweep 900 RPM (in plastic body)Ventilating fan fan | Nos | 29.00 | 1044.00 | 30,276.00 |
| | | (b) 300 mm sweep 900 RPM (in plastic body)Ventilating fan | | 26.00 | 1559.00 | 40,534.00 |
| | | (c) 300 mm sweep 900 RPM (In metal body) exhaust fan | Nos | 47.00 | 2,903.00 | 1,36,441.00 |
| | | (d) 450 mm sweep 900 RPM (In metal body) exhaust fan | Nos | 4.00 | 4,575.00 | 18,300.00 |
| | | e) 400 mm sweep oscillating type four speed wall mounting fan | Nos. | 3.00 | 2,470.00 | 7,410.00 |
| | | Erection Of Lighting Fixtures And Fans | | | | |
| 31.09 | 1.41 | Installation, testing and commissioning of pre-wired, fluorescent fitting / compact fluorescent fitting of all types, complete with all accessories and tube/lamp etc. directly on ceiling/ wall, including connections with 1.5 sq. mm FRLS PVC insulated, copper conductor, single core cable and earthing etc. as required. | Each | 1193.00 | 168.00 | 2,00,424.00 |

| S. No. | DSR 2019 | Description | Unit | Quantity | Rate (In Rs) | Amount (In Rs) |
|--------|-------------|--|------|----------|--------------|---------------------|
| 31.10 | 1.45 | Installation, testing and commissioning of ceiling fan, including wiring the down rods of standard length (upto 30 cm) with 1.5 sq. mm FRLS PVC insulated, copper conductor, single core cable, including providing and fixing phenolic laminated sheet cover on the Fan Box etc. as Required. | Each | 534.00 | 203.00 | 1,08,402.00 |
| 31.11 | 1.50 | Installation of Exhaust/wall fan in the existing opening, including making good the damage, Connection, Testing, Commissioning etc. as Required. | | | | |
| | 1.50.1 | Upto 450 mm sweep | Each | 109.00 | 363.00 | 39,567.00 |
| | | S/F modular type electronic fan regulator: | | | | |
| 31.12 | 1.25 | Supplying and fixing Two Module Stepped Type Electronic Fan Regulator on the existing modular plate switch box including connections but excluding modular plate etc. as required. | Each | 534.00 | 342.00 | 1,82,628.00 |
| | | Fixing Louvers / Shutters for Exhaust Fan: | | | | |
| 31.13 | 1.51 | Extra for Fixing the Louvers/ Shutters Complete with Frame for a Exhaust Fan of all sizes. | Each | 51.00 | 168.00 | 8,568.00 |
| | | Extra Down GI Pipe 15mm Dia: | | | | |
| 31.14 | 1.47 | Supplying and Fixing Extra Down Rod of 10 cm Length G.I. pipe, 15 mm dia, heavy gauge including painting etc. as required. (Note : More than 5 cm length shall be rounded to the nearest 10 cm and 5 cm or less shall be ignored). | Each | 534.00 | 33.00 | 17,622.00 |
| | | Total of sub-head (31.0) (Non DSR) | | | | 20,15,244.00 |
| | | Total of sub-head (31.0) (DSR) | | | | 5,57,211.00 |
| | | ELECTRICAL WORKS (External) | | | | |
| 32.0 | | Transformer and HT Panel | | | | |
| 32.01 | MR 1 | 11KV HT VCB PANEL - IN DOOR TYPE | | | | |
| | | Supplying, installation, testing and commissioning of IN DOOR Type, floor mounting, 11KV HT panel unit made out of M.S sheet steel clad dust and vermin proof with necessary control fuses/MCBs, Termination arrangements for Incoming and Outgoing Cable of 3Cx120 Sq.mm Al.HT XLPE cable, and earthed cable, Terminal Blocks, Earthing, Powder coated painting, Sign writing and Base channels etc. with complete all accessories as required. as per Requirements comprising of the following | | | | |
| | | INCOMING : | | | | |
| | | i) 630Amps, 11kV, 3 phase 50Hz, 21KA / 3Sec, Draw-out type Vacuum Circuit Breaker. fitted with 230V AC spring charging motor, 110V DC tripping and closing coils, 8NO+8NC Aux. conductor mechanical on off indicator, spring charging / discharge Indication, automatic safety shutter and with anti-pumping feature with necessary required accessories | | | | |
| | | ii) 3 phase 11 KV/110 Volts PT, class 1 accuracy and 100 VA burden with 1 No Voltmeter (0-15 kV), Digital type, selector switch for voltmeter and protection fuses for HT metering upto 12 kV on incomer. | | | | |
| | | iii) Dual core dual ratio 3 CTs 400/200/5+5A of 15 VA burden and accuracy class1.0 for metering and class 5P10 for protection. | | | | |
| | | iv) (0-400 A) Ammeter, digital type with selector switch for Ammeter. | | | | |
| | | v) Digital Multifunction Meter. | | | | |
| | | vi) Microprocessor based numerical relay for Over current and Earth fault protection with directional control. | | | | |
| | | vii) Phase indicating lamps with HRC fuses. | | | | |
| | | viii) Indicating lamps to indicate, RYB, ON, OFF, OPEN, CLOSE, TRIP, SPRING CHARGED, TRIP CIRCUIT HEALTHY | | | | |
| | | ix) Test terminal block | | | | |
| | | x) Trip/Neutral/close switch | | | | |
| | | xi) Copper bus bar for earthing (common) | | | | |
| | | xii) master trip relay & trip circuit healthy supervision relay. | | | | |
| | | BusBar: 630 Amps, 11kV, 50Hz, 3Phase, 25 KA / 3Sec. Copper busbars. | | | | |
| | | The11KV HT VCB PANEL shall be complete with as per SLD and specifications. | set | 1.00 | 448633.00 | 4,48,633.00 |
| 32.02 | MR 2 | 11KV TRANSFORMER (11 KV /0.433 KV) (250 KVA) | | | | |

| S. No. | DSR 2019 | Description | Unit | Quantity | Rate (In Rs) | Amount (In Rs) |
|--------|----------|---|------|----------|--------------|---------------------|
| | | Supplying, installation, testing and commissioning of 250 kVA, (Energy efficiency Level -2) 11kV / 433 Volts, 3 phase, 50Hz,vector group Dyn11 (delta -star connected), Indoor 'ONAN' type, copper wound transformer with OFF load tap changing arrangement on HV side in steps of +/- 2.5%, +/- 5% & +/- 7.5%, on H.V. side with HT cable chamber suitable for Heat shrinkable joint with XLPE cable (cable entry from bottom) and LT connection chamber suitable for connecting Bus duct arrangement and equipped with other essential accessories including providing complete with all fittings, accessories etc. and lifting lugs i/c first filling of filtered dehydrated oil, supplying grouting suitable MS Channel on the plinth for placing the transformer etc., complete and confirming to IS 1180 (Part-1): 2014, level - 2 & section 3 of CPWD General specification for Electrical works (Part -IV Substation 2013 as amended up to date) and as per specifications. | set | 1.00 | 731480.00 | 7,31,480.00 |
| | | (PLEASE NOTE THE TRANSFORMER SHALL BE IN COMPLIANCE WITH NEW REGULATION IS 1180 or Equivalent IEC Standard FOR LOSSES AND EFFICIENCY and amended upto date) | | | | |
| | | Total of sub-head (32.0) (Non DSR) | | | | 11,80,113.00 |
| 33.0 | | PANELS | | | | |
| 33.01 | MR 4 | EM. SUPPLY PANEL | | | | |
| | | Supply , installation, testing, Design, manufacture, supply inspection, handling, assembling, affecting proper connections, testing and commissioning of 1.6/2mm CRCA sheet steel fabricated cubical type Main L.T. Panel floor mounting Extensible Type, dust & vermin proof, front operated construction, enclosure class - IP 42, As per IEC 60439 after proper treatment with 9 tank process with top/bottom removable gland plates, as required, double compression type cable glands, earth bus, hinged and lockable doors to achieve dust and vermin proof complete with all inter connections small wiring by min. 1.5-2.5 sq. mm. FR copper wires, ckt labels etc. The panel feeders shall be suitable for terminating suitable nos. 3.5 / 4 core armoured aluminium cable as required. | | | | |
| | | INCOMING: | | | | |
| | | 1 nos. 100A 415V,FP MCCB of 25kA with thermal magnetic release, overload, short circuit and Earth fault protection. | | | | |
| | | 1 no. 100A 17KA rating FPAutomatic Transfer Switch (ATS) must comply with IEC60947-6-1 standards. | | | | |
| | | 1 no. Digital type Multifunction Meters to show (V, A, kWh, KVAh, KW, KVA, KVAR, PF, Hz.) with cast resin CTs. | | | | |
| | | 1 Set of phase indicating lamps with MCB protection. | | | | |
| | | OUTGOING | | | | |
| | | 1 nos. 100A 415V, TP MCCB of 25 KA with O/L and S/C protection.(For pump set) | | | | |
| | | 6 nos. 63A 4P MCCB (For Toilets, common areas of School bldg., Both hostels, Kitchen & dining) | | | | |
| | | 2 nos. 63A, 4P MCCB only Space. | | | | |
| | | 2 nos. 40A 415V, 4P MCCB of 10kA with 40A 4P Contactor & timer switch . | | | | |
| | | 2 nos. 25A 415V, 4P MCCB (SPARE) | Each | 1.00 | 167885.00 | 1,67,885.00 |
| 33.02 | MR 3 | Main LT PANEL | | | | |
| | | NOTE:- MCCB's wherever specified upto 250A shall be Thermal Magnetic & Above 250A will be Microprocessor based inbuilt protections. | | | | |
| | | Supply , installation, testing, Design, manufacture, supply inspection, handling, assembling, affecting proper connections, testing and commissioning of 1.6/2mm CRCA sheet steel fabricated cubical type Main L.T. Panel floor mounting Extensible Type, dust & vermin proof, front operated construction, enclosure class - IP 42, As per IEC 60439 after proper treatment with 9 tank process with top/bottom removable gland plates, as required, double compression type cable glands, earth bus, hinged and lockable doors to achieve dust and vermin proof complete with all inter connections small wiring by min. 1.5-2.5 sq. mm. FR copper wires, ckt labels etc. The panel feeders shall be suitable for terminating suitable nos. 3.5 / 4 core armoured aluminium cable as required | | | | |
| | | All MCCB's shall be lcs = 100% lcu, with rotary handle & pad locking arrangement. All TP MCCB shall be with heavy duty solid isolable neutral link. | | | | |
| | | The breaking capacity specified for all MCCB's breakers is lcs value (service rating). | | | | |
| | | Each Incoming (ACB/MCCB) shall have ON/OFF/Trip/ LED indication on panel Front door. | | | | |
| | | The incoming MCCB shall be Microprocessor based with inbuilt O/L & S/C release with E/F protection and all Outgoings MCCB's shall be thermal-magnetic based with inbuilt O/L & S/C release. | | | | |

| S. No. | DSR 2019 | Description | Unit | Quantity | Rate (In Rs) | Amount (In Rs) |
|--------|----------|--|------|----------|--------------|----------------|
| | | Incoming From TRANSFORMER 1 (250 KVA) - 1 NOS. (Phase I) | | | | |
| | | Incomer : 1 Nos 400A TP MCCB 36KA with Thermal Magnetic Release | | | | |
| | | 1 No. Digital Ammeter | | | | |
| | | 1 No. Digital Voltmeter | | | | |
| | | 1 set of 3 CT's of ratio 400/5A, Class 1.0 accuracy 15 VA burden for Metering. | | | | |
| | | 1 set of 3 CT's of ratio 400/5A, Class 1.0 accuracy 15 VA burden for APFCR. | | | | |
| | | 3 Nos. LED Type phase indicating lamps, each lamp shall be with backup MCB | | | | |
| | | 3 Nos. LED Type Indicating lamp for indicating the status of feeder - ON / OFF / TRIP. Each lamp shall be with backup MCB. | | | | |
| | | 6A SP 10KA MCB | | | | |
| | | Incoming From Supply Source-2 - 1 Nos 400A TP MCCB 36KA with Thermal Magnetic Release (Phase II) - for future Feeder | | | | |
| | | BUS COUPLER : 1 Nos 400A TP MCCB 36KA . It should be positioned in such manner so that all emergency loads and normal loads are separated by separate bus bar chamber in the panel. | | | | |
| | | Interlocking : Electrical as well as Mechanical Interlocking between incomers and bus coupler as per requirement | | | | |
| | | BUS BAR | | | | |
| | | TPN Aluminium Bus Bars of Minimum 500 Amp with Heat shrinkable coloured sleeves , Shrouds at Joints and including DMC/SMC bus bars supports at required interval complete for cross section, side supports and their spacing etc. | | | | |
| | | OUT GOING | | | | |
| | | 21 Nos. Outgoing Feeders :- | | | | |
| | | 1 Nos. 250A, TP 25KA MCCB (CAPACITOR PANEL) | | | | |
| | | 1 Nos. 250A, FP 25KA MCCB (TYPE II METER BOARD PANEL) | | | | |
| | | 1 Nos. 200A, FP 25KA MCCB (TYPE III METER BOARD PANEL - BLOCK 1) | | | | |
| | | 1 Nos. 160A, FP 25KA MCCB (TYPE III METER BOARD PANEL - BLOCK 2) | | | | |
| | | 1 No 160 AMP 4P 25KA MCCB (SCHOOL BUILDING PANEL) | | | | |
| | | 1 No 125 AMP 4P 18KA MCCB (Girls Hostel-II) | | | | |
| | | 1 No 160 AMP 4P 25KA MCCB (FIRE FIGHTING) | | | | |
| | | 1 No 100 AMP 4P 18KA MCCB (Pump Room Panel) | | | | |
| | | 1 No 100 AMP 4P 18KA MCCB (EXTERNAL LIGHTING - 1) | | | | |
| | | 1 No 100 AMP 4P 18KA MCCB (EXTERNAL LIGHTING - 2) | | | | |
| | | 1 No 63 AMP 4P 10KA MCCB (GUEST HOUSE DB) | | | | |
| | | 1 Nos. 125A, FP 18KA MCCB (BOYS HOSTEL-I & WARDEN BLOCK PANEL) | | | | |
| | | 1 Nos. 125A, FP 18KA MCCB (GIRLS HOSTEL-I & WARDEN BLOCK PANEL) | | | | |
| | | 1 Nos. 100A, FP 18KA MCCB (PRINCIPAL QUARTER PANEL) | | | | |
| | | 1 Nos. 200, FP 25KA MCCB (To Emergency MV Panel) | | | | |
| | | 1 Nos. 160, FP 25KA MCCB (Boys Hostel-II) | | | | |
| | | 3 No 63 AMP 4P 10KA MCCB (Spare) | | | | |
| | | Spare space for MCCB - 02 Nos. | | | | |
| | | Complete Panel as Above and complete | set | 1.00 | 457843.00 | 4,57,843.00 |
| 33.03 | MR 4 | AUTOMATIC POWER FACTOR CORRECTION PANEL (CAPACITOR PANEL) - 90 KVAR | | | | |
| | | Supplying, Installation, Testing and Commissioning of cubicle type capacitor panel suitable for 415 & 3 phase 50 HZ A.C. supply System fabricated in design from CRCA Sheet Steel of 2 mm thick for frame work and cover, 3 mm thick for gland plates i/c powder coating in approve shade having 200 AMP capacity TPN Aluminium bus bar DMC/SMC bus bar support entire pannel should have common Al. earth bar for size 50 mm x 5 mm i/c Providing & fixing following switch gear mounting there on fans,grills for propor ventillation complete with gaskets & inner connection i/c connection with existing CTS in the main CT Panel complete as reqd. The panel board shall be of dust and vermm proof with degree of protection IP 42) | | | | |
| | | a) 250 Amps TP MCCB with Thermal Magnetic Based release (Ics=100% Icu) - 1 No. | | | | |
| | | b) 250A, 4 strip Tinned Aluminium busbar -1 Set | | | | |
| | | c) Micro processor based automatic Power factor control relay i/c power factor metre in 8 steps | | | | |
| | | d) Multi functional meters with suitable CTS and protection MCBS 1 set. | | | | |
| | | e) 3 Nos. Phase indicating light (lamp) with MCBs protection. | | | | |
| | | OUTGOINGS - | | | | |

| S. No. | DSR 2019 | Description | Unit | Quantity | Rate (In Rs) | Amount (In Rs) |
|--------|----------|--|------|----------|--------------|----------------|
| | | 2 Set - 63A Amp TP MCB 10 KA and Capacitor duly switching contactor for 20 KVAR capacity auto manual selector switch start/stop push button on/off indicating lamp with protection MCB & delay timer complete i/c 20 KVAR Normal Duty 440V capacitor bank with inter Connection | | | | |
| | | 4 Set -32 Amp TP MCB 10 KA and Capacitor duly switching contactor for 10 KVAR capacity auto manual selector switch start/stop push button on/off indicating lamp with protection MCB & delay timer complete i/c 10 KVAR Normal Duty 440V capacitor bank with inter Connection | | | | |
| | | 2 Set - 16 Amp TP MCB 10 KA and Capacitor duly switching contactor for 5 KVAR capacity auto manual selector switch start/stop push button on/off indicating lamp with protection MCB & delay timer complete i/c 5 KVAR Normal Duty 440V capacitor bank with inter Connection | | | | |
| | | Capacitor panel should switch OFF when DG starts. Control wiring should be done for it. | | | | |
| | | complete panel as above and complete | set | 1.00 | 167703.00 | 1,67,703.00 |
| 33.04 | MR 5 | SCHOOL BUILDING MAIN DISTRIBUTION PANEL | | | | |
| | | Design, manufacture, supply, installation, testing and commissioning of cubicle type panel fabricated out of CRCA sheet steel , floor mounted totally enclosed switchbaord suitable for use of 415 volts , 3 phase, 50 HZ complete with aluminium bus bar and all accessories including supply and fixing of following incoming and outgoing switchgears, Panel Should Have Double Earthing Provision which connected to the nearest earth grid. | | | | |
| | | NOTE:- MCCB's wherever specified upto 250A shall be Thermal Magnetic & Above 250A will be Microprocessor based inbuilt protections. | | | | |
| | | INCOMER : 160 AMP FP MCCB | | | | |
| | | 3 Nos. Phase Indication light (lamp) with MCBs protection. | | | | |
| | | Multi functional meters (VAF) with suitable CTS and protection MCBS 1 set. | | | | |
| | | BUS BAR : 200 AMP, 500 Volts, 3 phase 50 HZ 4P high conductivity electrolytic Aluminium bus bar of suitable length, insulated by heat shrinkable sleeves. The current density of bus bar shall be minimum 0.6 sq mm / amp. | | | | |
| | | The Maximum allowable temperature for the Bus bar to be restricted to 90 deg C. The temperature rise should be restricted to 45 deg C above ambient temperature. | | | | |
| | | OUT GOINGS : | | | | |
| | | 1 No 63 AMP 4P MCCB (UPS PANEL) | | | | |
| | | 1 No 63 AMP 4P MCCB (GROUND FLOOR LIGHT + POWER DB 1) | | | | |
| | | 1 No 63 AMP 4P MCCB (GROUND FLOOR LIGHT + POWER DB 2) | | | | |
| | | 1 No 63 AMP 4P MCCB (GROUND FLOOR LIGHT + POWER DB 3) | | | | |
| | | 1 No 63 AMP 4P MCCB (GROUND FLOOR LIGHT + POWER DB 4) | | | | |
| | | 1 No 63 AMP 4P MCCB (FIRST FLOOR LIGHT + POWER DB 1) | | | | |
| | | 1 No 63 AMP 4P MCCB (FIRST FLOOR LIGHT + POWER DB 2) | | | | |
| | | 1 No 63 AMP 4P MCCB (FIRST FLOOR LIGHT + POWER DB 3) | | | | |
| | | 1 No 63 AMP 4P MCCB (FIRST FLOOR LIGHT + POWER DB 4) | | | | |
| | | 1 No 63 AMP 4P MCCB (SECOND FLOOR LIGHT + POWER DB 1) | | | | |
| | | 1 No 63 AMP 4P MCCB (SECOND FLOOR LIGHT + POWER DB 2) | | | | |
| | | 1 No 63 AMP 4P MCCB (SECOND FLOOR LIGHT + POWER DB 3) | | | | |
| | | 1 No 63 AMP 4P MCCB (SECOND FLOOR LIGHT + POWER DB 4) | | | | |
| | | complete panel as above and complete | set | 1.00 | 71921.00 | 71,921.00 |
| 33.05 | MR 6 | UPS PANEL | | | | |
| | | Design, manufacture, supply, installation, testing and commissioning of cubicle type panel fabricated out of CRCA sheet steel , floor mounted totally enclosed switchbaord suitable for use of 415 volts , 3 phase, 50 HZ complete with aluminium bus bar and all accessories including supply and fixing of following incoming and outgoing switchgears, Panel Should Have Double Earthing Provision which connected to the nearest earth grid. | | | | |
| | | INCOMER : 1 Nos 63 AMP FP MCB (Thru Bypass Switch 10 kva UPS) | | | | |

| S. No. | DSR 2019 | Description | Unit | Quantity | Rate (In Rs) | Amount (In Rs) |
|--------|----------|---|------|----------|--------------|----------------|
| | | BUS BAR : 100 AMP, 500 Volts, 3 phase 50 HZ 4P high conductivity electrolytic Aluminium bus bar of suitable length, insulated by heat shrinkable sleeves. The current density of bus bar shall be minimum 06 sq mm / amp. | | | | |
| | | The Maximum allowable temperature for the Bus bar to be restricted to 90 deg C. The temperature rise should be restricted to 45 deg C above ambient temperature. | | | | |
| | | OUT GOINGS : | | | | |
| | | 1 No 63 AMP DP MCB (GROUND FLOOR UPS DB 1) | | | | |
| | | 1 No 40 AMP DP MCB (GROUND FLOOR UPS DB 2) | | | | |
| | | 1 No 40 AMP DP MCB (FIRST FLOOR UPS DB 1) | | | | |
| | | 1 No 40 AMP DP MCB (FIRST FLOOR UPS DB 2) | | | | |
| | | 2 No 40 AMP DP MCB (Second Floor UPS DB-1&2) | | | | |
| | | 1 No 40 AMP DP MCB (SPARE) | | | | |
| | | complete panel as above and complete | set | 1.00 | 51558.00 | 51,558.00 |
| 33.06 | MR 7 | BOYS HOSTEL MAIN DISTRIBUTION BOARD | | | | |
| | | Design, manufacture, supply, installation, testing and commissioning of cubicle type panel fabricated out of CRCA sheet steel , floor mounted totally enclosed switchbaord suitable for use of 415 volts , 3 phase, 50 HZ complete with aluminium bus bar and all accessories including supply and fixing of following incoming and outgoing switchgears, Panel Should Have Double Earthing Provision which connected to the nearest earth grid | | | | |
| | | NOTE:- MCCB's wherever specified upto 250A shall be Thermal Magnetic & Above 250A will be Microprocessor based inbuilt protections. | | | | |
| | | INCOMER : 125 AMP FP MCCB | | | | |
| | | 3 Nos. Phase Indication light (lamp) with MCBs protection. | | | | |
| | | Multi functional meters (VAF) with suitable CTS and protection MCBS 1 set. | | | | |
| | | BUS BAR : 160 AMP, 500 Volts, 3 phase 50 HZ 4P high conductivity electrolytic Aluminium bus bar of suitable length, insulated by heat shrinkable sleeves. The current density of bus bar shall be minimum 0.6 sq mm / amp. | | | | |
| | | The Maximum allowable temperature for the Bus bar to be restricted to 90 deg C. The temperature rise should be restricted to 45 deg C above ambient temperature. | | | | |
| | | OUT GOINGS : | | | | |
| | | 1 No 63 AMP FP MCCB (GROUND FLOOR LIGHT + POWER DB 1) | | | | |
| | | 1 No 63 AMP FP MCCB (GROUND FLOOR LIGHT + POWER DB 2) | | | | |
| | | 1 No 63 AMP FP MCCB (GROUND FLOOR LIGHT + POWER DB 3) | | | | |
| | | 1 No 63 AMP FP MCCB (GROUND FLOOR LIGHT + POWER DB 4) | | | | |
| | | 1 No 63 AMP FP MCCB (FIRST FLOOR LIGHT + POWER DB 1) | | | | |
| | | 1 No 63 AMP FP MCCB (FIRST FLOOR LIGHT + POWER DB 2) | | | | |
| | | 1 No 63 AMP FP MCCB (FIRST FLOOR LIGHT + POWER DB 3) | | | | |
| | | 1 No 63 AMP FP MCCB (FIRST FLOOR LIGHT + POWER DB 4) | | | | |
| | | 1 No 63 AMP FP MCCB (WARDEN BLOCK 1 DB) | | | | |
| | | 3 No 63 AMP FP MCCB (SPARE) | | | | |
| | | complete panel as above and complete | set | 2.00 | 70015.00 | 1,40,030.00 |
| 33.07 | MR 8 | GIRLS HOSTEL MAIN DISTRIBUTION BOARD | | | | |
| | | Design, manufacture, supply, installation, testing and commissioning of cubicle type panel fabricated out of CRCA sheet steel , floor mounted totally enclosed switchbaord suitable for use of 415 volts , 3 phase, 50 HZ complete with aluminium bus bar and all accessories including supply and fixing of following incoming and outgoing switchgears, Panel Should Have Double Earthing Provision which connected to the nearest earth grid | | | | |
| | | NOTE:- MCCB's wherever specified upto 250A shall be Thermal Magnetic & Above 250A will be Microprocessor based inbuilt protections. | | | | |
| | | INCOMER : 125 AMP FP MCCB | | | | |
| | | 3 Nos. Phase Indication light (lamp) with MCBs protection. | | | | |
| | | Multi functional meters (VAF) with suitable CTS and protection MCBS 1 set. | | | | |
| | | BUS BAR : 160 AMP, 500 Volts, 3 phase 50 HZ 4P high conductivity electrolytic Aluminium bus bar of suitable length, insulated by heat shrinkable sleeves. The current density of bus bar shall be minimum 0.6 sq mm / amp. | | | | |
| | | The Maximum allowable temperature for the Bus bar to be restricted to 90 deg C. The temperature rise should be restricted to 45 deg C above ambient temperature. | | | | |
| | | OUT GOINGS : | | | | |

| S. No. | DSR 2019 | Description | Unit | Quantity | Rate (In Rs) | Amount (In Rs) |
|--------|----------|--|-------|----------|--------------|---------------------|
| | | 1 No 63 AMP FP MCCB (GROUND FLOOR LIGHT + POWER DB 1) | | | | |
| | | 1 No 63 AMP FP MCCB (GROUND FLOOR LIGHT + POWER DB 2) | | | | |
| | | 1 No 63 AMP FP MCCB (GROUND FLOOR LIGHT + POWER DB 3) | | | | |
| | | 1 No 63 AMP FP MCCB (GROUND FLOOR LIGHT + POWER DB 4) | | | | |
| | | 1 No 63 AMP FP MCCB (FIRST FLOOR LIGHT + POWER DB 1) | | | | |
| | | 1 No 63 AMP FP MCCB (FIRST FLOOR LIGHT + POWER DB 2) | | | | |
| | | 1 No 63 AMP FP MCCB (FIRST FLOOR LIGHT + POWER DB 3) | | | | |
| | | 1 No 63 AMP FP MCCB (FIRST FLOOR LIGHT + POWER DB 4) | | | | |
| | | 1 No 63 AMP FP MCCB (WARDEN BLOCK 1 DB) | | | | |
| | | 3 No 63 AMP FP MCCB (SPARE) | | | | |
| | | complete panel as above and complete | set | 2.00 | 70015.00 | 1,40,030.00 |
| 33.08 | MR 6 | TYPE -II & III STAFF QTRS. DISTRIBUTION BOARD | | | | |
| | | Design, manufacture, supply, installation, testing and commissioning of cubicle type panel fabricated out of CRCA sheet steel , floor mounted totally enclosed switchbaord suitable for use of 415 volts , 3 phase, 50 HZ complete with aluminium bus bar and all accessories including supply and fixing of following incoming and outgoing switchgears, Panel Should Have Double Earthing Provision which connected to the nearest earth grid. | | | | |
| | | NOTE:- MCCB's wherever specified upto 250A shall be Thermal Magnetic & Above 250A will be Microprocessor based inbuilt protections. | | | | |
| | | INCOMER : 125 AMP FP MCCB | | | | |
| | | 3 Nos. Phase Indication light (lamp) with MCBs protection. Multi functional meters (VAF) with suitable CTS and protection MCBS 1 set. | | | | |
| | | BUS BAR : 160 AMP, 500 Volts, 3 phase 50 HZ 4P high conductivity electrolytic Aluminium bus bar of suitable length, insulated by heat shrinkable sleeves. The current density of bus bar shall be minimum 0.6 sq mm / amp The Maximum allowable temperature for the Bus bar to be restricted to 90 deg C. The temperature rise should be restricted to 45 deg C above ambient temperature | | | | |
| | | OUT GOINGS : | | | | |
| | | 12 Nos 63 AMP 2P MCB (For each Qtr.DBs and Spare) | | 3.00 | 46763.00 | 1,40,289.00 |
| | | complete panel as above and complete | | | | |
| 33.09 | MR 10 | EXTERNAL LIGHT FEEDER PILLAR | | | | |
| | | Design, Manufacture, Supply, Installation, Testing and Commissioning of Panel Fabricated out of 16 SWG CRCA sheet steel, IP 54, wall / floor mounting type with rain canopy The sheet steel shall undergo minimum 7 tank treatment followed by finishing powder coating of min 60 micron thickness. the board includes 415 /240 V electrolytic Aluminium Bus Bar, removable gland plates, cable glands, including connection with outgoing feeders complete in all respect, Panel Should Have Double Earthing Provision Which Connected to the Nearest Earth Grid. | | | | |
| | | INCOMER: | | | | |
| | | 1 no. 100A, 25KA 4P MCCB with Thermal Magnetic based releases, ON indication, + 3 Nos 63A DP MCB For each Phase.with 3 Nos Astronomical Weekly programmable time switch (SST- 1min) ON Phase for automaitc switching of landscape light fixtures at sun set and sun rise or twilight (auto on/ auto off and auto mode) with manual override faclity with 12/24 hour display format with suitable battery and indication for relay status i/c programming at site. | | | | |
| | | BUS BAR | | | | |
| | | TPN Aluminium bus bar with heat Shrink Sleeve rated for 125A. | | | | |
| | | OUTGOING | | | | |
| | | 18 nos 16A DP MCB (For Compound Group Light + Spare) | | | | |
| | | 4 Nos 16KA 40A FP MCCB (Spare) | | | | |
| | | 1 nos 40A FP MCCB (BORE WELL STAND BY) | | | | |
| | | Other items such as | | | | |
| | | 1 Set of control wiring | | | | |
| | | 1 Set of designation plates | | | | |
| | | All Items complete as above | set | 2.00 | 87147.00 | 1,74,294.00 |
| | | | | | | |
| | | Total of sub-head (33.0) (Non DSR) | | | | 15,11,553.00 |
| 34.0 | | LT Cable And Accessories | | | | |
| 34.01 | | Supply Of L.T. Cable: | | | | |
| | | Supplying of Following Sizes of 1.1 kV Grade Multicore Aluminium Conductor XLPE Power Cable Insulated armoured cable conforming to IS:7098 (Part - I) or as per Relevant IS Code complete with all Amendments etc and should be NABL certified as required. | | | | |
| | MR 11 | 3.5 C X 150 Sq.mm Al. XLPE arm. | Metre | 435.00 | 775.00 | 3,37,125.00 |
| | MR 12 | 3.5 C X 120 Sq.mm Al. XLPE arm. | Metre | 370.00 | 666.00 | 2,46,420.00 |

| S. No. | DSR 2019 | Description | Unit | Quantity | Rate (In Rs) | Amount (In Rs) |
|--------|------------|---|-------|----------|--------------|---------------------|
| | MR 13 | 3.5 C X 95 Sq.mm Al. XLPE arm. | Metre | 2010.00 | 535.00 | 10,75,350.00 |
| | MR 14 | 3.5 C X 70 Sq.mm Al. XLPE arm. | Metre | 1555.00 | 425.00 | 6,60,875.00 |
| | MR 15 | 3.5 C X 50 Sq.mm Al. XLPE arm. | Metre | 140.00 | 317.00 | 44,380.00 |
| | MR 16 | 3.5 C X 35 Sq.mm Al. XLPE arm. | Metre | 260.00 | 245.00 | 63,700.00 |
| | MR 17 | 3.5 C X 25 Sq.mm Al. XLPE arm. | Metre | 420.00 | 198.00 | 83,160.00 |
| | DSR 7 | LT Cable Laying | | | | |
| 34.02 | DSR 7.1 | Laying of One Number PVC Insulated And PVC Sheathed / XLPE Power Cable of 1.1 kV Grade of Following Size Direct in Ground Including Excavation, Sand Cushioning, Protective Covering and Refilling the Trench etc. as required. | | | | |
| | DSR7.1.1 | Upto 35 sq. mm | Metre | 380.00 | 323.00 | 1,22,740.00 |
| | DSR 7.1.2 | Above 35 sq. mm and upto 95 sq. mm | Metre | 3205.00 | 338.00 | 10,83,290.00 |
| | DSR 7.1.3 | Above 95 sq. mm and upto 185 sq. mm | Metre | 505.00 | 352.00 | 1,77,760.00 |
| 34.03 | DSR 7.2 | Laying of one number additional PVC insulated and PVC sheathed / XLPE power cable of 1.1 KV grade of following size direct in ground in the same trench in one tier horizontal formation including excavation, sand cushioning, protective covering and refilling the trench etc as required. | | | | |
| | DSR 7.2.1 | Upto 35 sq. mm | Metre | 100.00 | 222.00 | 22,200.00 |
| | DSR 7.2.2 | Above 35 sq. mm and upto 95 sq. mm | | 200.00 | 236.00 | 47,200.00 |
| | DSR 7.2.3 | Above 95 sq. mm and upto 185 sq. mm | | 100.00 | 251.00 | 25,100.00 |
| 34.04 | DSR 7.3 | Laying of one number PVC insulated and PVC sheathed / XLPE power cable of 1.1 KV grade of following size direct in ground including excavation and refilling the trench etc as required. but excluding sand cushioning and protective covering. | | | | |
| | DSR 7.3.1 | Upto 35 sq. mm | Metre | 50.00 | 167.00 | 8,350.00 |
| | DSR7.3.2 | Above 35 sq. mm and upto 95 sq. mm | Metre | 200.00 | 181.00 | 36,200.00 |
| | DSR7.3.3 | Above 95 sq. mm and upto 185 sq. mm | | 100.00 | 196.00 | 19,600.00 |
| 34.05 | DSR 7.5 | Laying of one number PVC insulated & PVC sheathed/ XLPE Power cable of 1.1 KV grade of following size in the existing RCC/HUME/METAL pipe as required. | | | | |
| | DSR 7.5.1 | Upto 35 sq. mm | Metre | 50.00 | 31.00 | 1,550.00 |
| | DSR 7.5.2 | Above 35 sq. mm and upto 95 sq. mm | Metre | 50.00 | 47.00 | 2,350.00 |
| | DSR 7.5.3 | Above 95 sq. mm and upto 185 sq. mm | Metre | 50.00 | 64.00 | 3,200.00 |
| 34.06 | DSR 7.7 | Laying and fixing of one number PVC insulated and PVC sheathed / XLPE power cable of 1.1 KV grade of following size on wall surface as required. | | | | |
| | DSR 7.7.1 | Upto 35 sq. mm (clamped with 1mm thick saddle) | Metre | 100.00 | 39.00 | 3,900.00 |
| | DSR 7.7.2 | Above 35 sq. mm and upto 95 sq. mm (clamped with 25x3mm MS flat clamp) | Metre | 50.00 | 104.00 | 5,200.00 |
| | DSR 7.7.3 | Above 95 sq. mm and upto 185 sq. mm (clamped with 25/40x3mm MS flat clamp) | Metre | 50.00 | 122.00 | 6,100.00 |
| | DSR 9 | LT CABLE JOINTING & END TERMINATION | | | | |
| 34.07 | DSR 9.1 | Supplying and Making End Termination With Brass Compression Gland and Aluminium lugs for Following Size of PVC Insulated and PVC Sheathed / XLPE Aluminium Conductor Cable of 1.1 kV Grade as Required. | | | | |
| | DSR 9.1.20 | 3½ X 25 sq. mm (28mm) | Each | 10.00 | 250.00 | 2,500.00 |
| | DSR 9.1.21 | 3½ X 35 sq. mm (32mm) | Each | 2.00 | 300.00 | 600.00 |
| | DSR 9.1.22 | 3½ X 50 sq. mm (35mm) | Each | 2.00 | 329.00 | 658.00 |
| | DSR 9.1.23 | 3½ X 70 sq. mm (38mm) | Each | 14.00 | 368.00 | 5,152.00 |
| | DSR 9.1.24 | 3½ X 95 sq. mm (45mm) | Each | 14.00 | 473.00 | 6,622.00 |
| | DSR 9.1.25 | 3½ X 120 sq. mm (45mm) | Each | 2.00 | 489.00 | 978.00 |
| | DSR 9.1.26 | 3½ X 150 sq. mm (50mm) | Each | 10.00 | 555.00 | 5,550.00 |
| | | Total of sub-head (34.0) (Non DSR) | | | | 25,11,010.00 |
| | | Total of sub-head (34.0) (DSR) | | | | 15,86,800.00 |
| 35.0 | | HT Cable And Accessories | | | | |
| 35.01 | MR 18 | Supply of H.T. Cable | | | | |

| S. No. | DSR 2019 | Description | Unit | Quantity | Rate (In Rs) | Amount (In Rs) |
|--------|-----------|--|-------|----------|--------------|--------------------|
| | | Supply & Testing of following 11 KV(UE) grade multicore Aluminium conductor XLPE insulated cable, insulation screening with extruded semi conducting compound in combination with copper tape armoured cores laid up, inner sheath of PVC tape, galvanised steel flat strip armoured and overall PVC sheathed cable conforming to IS: 7098 (Part - II) and complete with all latest amendments etc. complete as required. | | | | |
| | | 3 C x 120 Sq. mm 11 KV (UE) | Metre | 180.00 | 1114.00 | 2,00,520.00 |
| 35.02 | DSR 8 | H.T. Cable Laying-DSR Item | | | | |
| | DSR 8.1 | H V CABLE LAYING | | | | |
| | DSR 8.1.1 | Laying of one number PVC insulated and PVC sheathed / XLPE power cable of 11 KV grade of following size direct in ground including excavation, sand cushioning, protective covering and refilling the trench etc as required. | | | | |
| | DSR 8.1.2 | Upto 120 sq. mm | Metre | 180.00 | 438.00 | 78,840.00 |
| | DSR 10.1 | H.T Termination: DSR Item | | | | |
| 35.03 | DSR 10.1 | Supply and making Indoor cable end jointing with cast resin compound, including lugs and other jointing materials for following size of 3 core, XLPE aluminium conductor cable of 11KV (UE) grade as required. | | | | |
| | 10.1.1 | 3 C x 120 Sq.mm (11KV UE) | Sets | 3.00 | 2398.00 | 7,194.00 |
| 35.04 | DSR 10.2 | Supply and making Outdoor cable end jointing with cast resin compound, including lugs and other jointing materials for following size of 3 core, XLPE aluminium conductor cable of 11KV (UE) grade as required. | | | | |
| | 10.2.2 | 3 C x 120 Sq.mm (11KV UE) | Sets | 1.00 | 5143.00 | 5,143.00 |
| | | Total of sub-head (35.0) (Non DSR) | | | | 2,00,520.00 |
| | | Total of sub-head (35.0) (DSR) | | | | 91,177.00 |
| 36.0 | DSR 2 | Miscellaneous Items - DSR | | | | |
| 36.01 | 2.21 | Providing and fixing M.V. danger notice plate of 200 mm X 150 mm, made of mild steel, at least 2 mm thick, and vitreous enameled white on both sides, and with inscription in single red colour on front side as required. | Nos. | 12.00 | 226.00 | 2,712.00 |
| 36.02 | 2.22 | Providing and fixing H.T. danger notice plate of 250 mm X 200 mm, made of mild steel, at least 2 mm thick, and vitreous enameled white on both sides, and with inscription in single Red colour on front side as required. | Nos. | 2.00 | 244.00 | 488.00 |
| 36.03 | 7.90 | Supplying and making cable route marker with cement concrete 1:2:4 (1 cement : 2 coarse sand : 4 graded stone aggregate 20 mm nominal size) of size 60 cm X 60 cm at the bottom and 50 cm X 50 cm at the top with a thickness of 10cm including inscription duly engraved as required. | Each | 5.00 | 530.00 | 2,650.00 |
| 36.04 | 7.10 | Supplying and fixing cable route marker with 10 cm X 10 cm X 5 mm thick G.I. plate with inscription there on, bolted /welded to 35 mm X 35 mm X 6 mm angle iron, 60 cm long and fixing the same in ground as required. | Each | 5.00 | 383.00 | 1,915.00 |
| | | Miscellaneous Items - MR Items | | | | |
| 36.05 | MR 19 | SITC of shock treatment chart (prescribed under I.E.rules) duly framed with glass and supported from back with hard board with supply of all material labour T & P etc for proper completion of work. (Approx front area = 1.20 sq M) | Nos. | 2.00 | 455.00 | 910.00 |
| 36.06 | MR 20 | SITC of First aid box as approved by Indian red cross conforming to IS : 2217. | Nos. | 2.00 | 334.00 | 668.00 |
| 36.07 | MR 21 | SITC of Fire Bucket stand made of M S angle suitable for and with 4 Nos Fire Buckets of 9.5 Ltrs capacity filled with | Set | 2.00 | 3277.00 | 6,554.00 |
| 36.08 | MR 22 | SITC of rubber gloves of 11 KV grade as per IS : 4770. | Set | 2.00 | 428.00 | 856.00 |
| 36.09 | MR 23 | Supplying and fixing of high voltage insulation mat of class B having 11 KV dielectric strength, 1000mm width and thickness of 2.5mm ISI approved as required including cutting to required lengths. | Metre | 1.00 | 3650.00 | 3,650.00 |
| 36.10 | MR 24 | Supplying and fixing of high voltage insulation mat of class B having 1.1 KV dielectric strength, 1000mm width and thickness of 2.0 mm ISI approved as required including cutting to required lengths. | Metre | 3.00 | 2475.00 | 7,425.00 |
| | | Total of sub-head (36.0) (DSR) | | | | 7,765.00 |
| | | Total of sub-head (36.0) (Non DSR) | | | | 20,063.00 |
| 37.0 | DSR 5 | Earthing | | | | |
| 37.01 | 5.4 | Earthing with G.I. earth plate 600 mm X 600 mm X 6 mm thick including accessories, and providing masonry enclosure with cover plate having locking arrangement and watering pipe of 2.7 meter long etc. with charcoal/ coke and salt as required.. (For BODY EARTHING of each Electrical Panels & Generator Neutral & Body Earthing) | Set | 32.00 | 6216.00 | 1,98,912.00 |

| S. No. | DSR 2019 | Description | Unit | Quantity | Rate (In Rs) | Amount (In Rs) |
|--------|----------|---|-------|----------|--------------|--------------------|
| 37.02 | 5.6 | Earthing with copper earth plate 600 mm X 600 mm X 3 mm thick including accessories, and providing masonry enclosure with cover plate having locking arrangement and watering pipe of 2.7 meter long etc. with charcoal/ coke and salt as required.. (For Transformer BODY & NEUTRAL EARTHING) | Set | 4.00 | 11794.00 | 47,176.00 |
| | 5.2 | Earthing with G.I. earth pipe 4.5 metre long, 40 mm dia including accessories, and providing masonry enclosure with cover plate having locking arrangement and watering pipe etc. with charcoal/ coke and salt as required | SET | 4.00 | 5308.00 | 21,232.00 |
| 37.03 | 5.15 | Providing and fixing 25 mm X 5 mm G.I. strip on surface or in recess for connections etc. as required. | Metre | 310.00 | 206.00 | 63,860.00 |
| 37.04 | 5.18 | Providing and fixing 6 SWG dia G.I. wire on surface or in recess for loop earthing along with existing surface/ recessed conduit/ submain wiring/ cable as required. | Metre | 200.00 | 37.00 | 7,400.00 |
| 37.05 | 5.14 | Providing and fixing 25 mm X 5 mm copper strip on surface or in recess for connections etc. as required. | Metre | 40.00 | 1009.00 | 40,360.00 |
| | 5.12 | Providing and laying earth connection from earth electrode with 6 SWG dia G.I. Wire in 15 mm dia G.I. pipe from earth electrode including connection with G.I. thimble excavation and re-filling as required. | Metre | 20.00 | 188.00 | 3,760.00 |
| | | Total of sub-head (37.0) (DSR) | | | | 3,82,700.00 |
| 38.0 | DSR 11 | Pole Erection | | | | |
| 38.01 | 11.3 | Erection of metallic pole of following length in cement concrete 1:3:6 (1 cement : 3 coarse sand : 6 graded stone aggregate 40 mm nominal size) foundation including excavation and refilling etc. as required. | | | | |
| | 11.3.1 | Above 4.5 metre and upto 6.5 metre | Each | 57.00 | 4492.00 | 2,56,044.00 |
| 38.02 | 11.6 | Supplying and embedding following dia G.I. pipe (medium class) in pole collar/ foundation (during casting) for cable entry including bending the pipe to the required shape , Hole Sealing to be done complete as required. | | | | |
| | 11.6.1 | 32 mm dia | Metre | 340.00 | 324.00 | 1,10,160.00 |
| | | Total of sub-head (38.0) (DSR) | | | | 3,66,204.00 |
| 39.0 | | External Lighting System | | | | |
| 39.01 | MR 26 | Supply , Installation, Testing & Commissioning of Integrated Post Top Lantern With 45W LED Lamp including suitable size dia G.I.Pipe Pole i/c connection with 3 x 2.5 sq.mm single core PVC insulated copper conductor cable from junction box to fixture as required. | Nos. | 2.00 | 4520.00 | 9,040.00 |
| 39.02 | MR 27 | Supply , Installation, Testing & Commissioning of 60 W LED with complete with pot optic reflector i/c connection with 3x2.5sq.mm single core PVC insulated copper conductor cable from junction box to fixture as required | Nos. | 45.00 | 3309.00 | 1,48,905.00 |
| 39.03 | MR 28 | Building Outer Light (60W LED) :- Supply, fitting, fixing and testing of building outer lighting luminaire aerodynamically shaped single piece pressure die-cast Aluminum luminaire with high power LEDs as light source and electronic driver (IP66), along with 60W LED Lamp as Energy saving as per drawing prescribed reflector and heat resistant toughened flat glass cover, with 5ft long 40mm dia G.I. pipe with 3 Nos. of iron clamps , anchor nut bolts with double washers as per direction of E/I or consultant as per drawing prescribed reflector and heat resistant toughened flat glass cover. (Make:- Philips/Trilux/Hevells-Endura Pearl NeoWindo | Each | 10.00 | 5030.00 | 50,300.00 |
| 39.04 | MR 29 | Supply, Installation, Testing and Commissioning of 200x160x98 (KVPC) Polycarbonate thermoplastics enclosure - junction box with I.P - 65 Protection with Terminals & cable hinged cover of approved design complete having gasket of internally embedded & made of polyetherene & should be weather proof, rust proof, dust proof, water proof - box shall be tested as per IEC - 60670-2/60670-22. the box shall have self threaded holes & provision for mounting din rail. with 2 Nos cable gland including supplying & fixing crimping 2 nos lugs & 1 nos 32A connector 6 way for looping the incoming & outgoing cables and also connection of the street light one 6A SP MCB Including Connection of 2x6 sqmm Cable etc as Required | Nos. | 73.00 | 1120.00 | 81,760.00 |
| 39.05 | MR 30 | Supply of Single bracket type GI sewage tubular pole of 6 Metre Pole (Above Ground) with Top-70 mm, bottom-135 mm, Base Plate 220x220x12 mm, PCD-225 mm, Foundation Bolts-M20X700 - 4 Nos., Single arm Bracket - 1 mtr long, with 48.3 mm OD pipe suitable for LED fitting. The pole shall be provided with suitable base plate arrangement for fixing on pedestal and looping box complete with MCB, brass connectors etc complete as required. The street lighting pole shall be in accordance with IS 2713. (For Road Street Light - 20 | | 37.00 | 10399.00 | 3,84,763.00 |

| S. No. | DSR 2019 | Description | Unit | Quantity | Rate (In Rs) | Amount (In Rs) |
|--------|----------|--|-------|----------|--------------|----------------|
| 39.06 | MR 31 | Supply of Double bracket type GI sewaged tubular pole of 6 Metre Pole (Above Ground) with Top-70 mm, bottom-135 mm, Base Plate 220x220x12 mm, PCD-225 mm, Foundation Bolts-M20X700 - 4 Nos., Double arm Bracket - 1 mtr long, with 48.3 mm OD pipe suitable for LED fitting. The pole shall be provided with suitable base plate arrangement for fixing on pedestal and looping box complete with MCB, brass connectors etc complete as required. The street lighting pole shall be in accordance with IS 2713. (For Road street light) | | 4.00 | 10929.00 | 43,716.00 |
| 39.07 | MR 32 | (A) SITC of Hybrid All In One Integrated Solar LED Street Light fitting rated for 40W output with integrated solar laminate of 80 Wp (or more) based on Mono crystalline cell technology, along with battery of rating 12.8V 30Ah (or more) based on Lithium Ferro Phosphate Chemistry (LiFePO4), with a light output of greater than 6000 Lumens (>6000), LEDs with a life greater than >50000Hrs and Lumen efficacy greater than 150Lm/W , with an autonomy of 2 days (24 hrs.)or more with dimming, INBUILT PROTECTIONS FOR LONGER RELIABILITY - Over Charge Protection, Deep Discharge Protection, Battery Reverse Polarity Protection, Load Short Circuit Protection, Load Open Circuit Protection, Reverse Polarity Protection for Panel and Over Temperature Protection. Surge Protection for Hybrid Models. The housing of the street light should be made of Extruded Aluminium / Die Cast Aluminium, equipped with battery charge controller of efficiency greater than 92%, hybrid controller efficiency of greater than 85% and motion detection sensor with atleast 12mtr range. The light fitting shall be complete with all accessories in all respect as per manufacturer design. The light should also be tested for its performance (LM 79), Ingress protection(IP 65 or more), Impact resistance (IK08 or more) from 3rd party NABL Labs / TUV / UL / MNRE Authorised labs. (Note:- Inhouse labs approved by NABL will not be acceptable, only 3rd part labs shall be considered . The lighting supplier should be able to provide immediate service support with a service centre on district level and must have a dedicated toll free number to register complaints. The warranty on the complete solar light shall be of 5 years.) | | 16.00 | 42800.00 | 6,84,800.00 |
| | | (B)The following certificates/documents are mandatory at the time of supply and after execution as and where applicable :- 1. EN50530 – MPPT Efficiency 2. IEC61547 3. IEC61000-3-2 – EMC 4. IEC 60598 – Part 1 – General requirement 5. IEC 62109 6. LM 79 REPORT 7. IK 08 8. IP 65 The Executant must submit the TDS, LM 79 report , IK 08 & IP 65 report of third party NABL lab , LM80 report of chip manufacturer in the department for obtaining the approval from the authority prior to start of work/ procurement of Solar street lights. Reports of inhouse lighting company Lab having NABL accreditation will not be acceptable. Test reports like EN50530 – MPPT Efficiency , IEC61547 ,IEC61000-3-2 – EMC , IEC 60598 – Part 1 – General requirement , IEC 62109 obtained from Third party NABL Lab/ TUV/UL/MNRE Lab's test report are required to be submitted by the executant along with manufacturer's warranty certificate in the name of concerned department for providing 5 years complete system warranty & providing immediate after sales service within the warranty period against manufacturing defects, LM 79 report,IP 65 report , IK 08 report against the supply of Hybrid AIO Solar lights for it's acceptance by the department | | | | |
| 39.08 | MR 33 | Supplying of Following sizes 1100 volt grade XLPE insulated PVC sheathed aluminium conductor armoured cables as per specification in existing laid in ground including cost of digging upto required depth, 150 mm sand all around the cable, brick protection and back filling, clamped to wall with suitable clamps including saddles fixing bolts, <u>Connection Testing and commissioning as Required</u> a) 2x6 sqmm | Metre | 3540.00 | 85.00 | 3,00,900.00 |
| | | Laying of one number PVC insulated and PVC sheathed / XLPE power cable of 1.1 kV grade of size up to 35 sq. mm | | | | |
| 39.09 | 7.3.1 | (a) direct in ground including excavation and refilling the trench etc. as required, but excluding sand cushioning and protective covering. | Metre | 2360.00 | 167.00 | 3,94,120.00 |
| | 7.7.1 | (b) On Surface | Metre | 870.00 | 39.00 | 33,930.00 |

| S. No. | DSR 2019 | Description | Unit | Quantity | Rate (In Rs) | Amount (In Rs) |
|--------|----------|---|-------|----------|--------------|---------------------|
| 39.10 | 7.5.1 | Laying of one number PVC insulated and PVC sheathed / XLPE power cable of 1.1 kV grade of following size in the existing RCC/ HUME/ METAL pipe as required. Upto 35 sq. mm | Metre | 310.00 | 31.00 | 9,610.00 |
| 39.11 | | Supplying and laying of following size DWC HDPE pipe ISI marked along with all accessories like socket, bend, couplers etc. conforming to IS 14930, Part II complete with fitting and cutting, jointing etc. in the existing trench, complete as required. | | | | |
| | 14.15.1 | 63 mm dia (OD-63 mm & ID-51 mm nominal) | Metre | 150.00 | 109.00 | 16,350.00 |
| | | Total of sub-head (39.0) (DSR) | | | | 4,54,010.00 |
| | | Total of sub-head (39.0) (Non DSR) | | | | 17,04,184.00 |
| 40.0 | | Uninterrupted Power Supply (UPS) - 10 kVA | | | | |
| 40.01 | MR 34 | Supply of 10 kVA Online UPS , IGBT UPS (Transformer-less Design). | | | | |
| | | Supply of SMF Batteries (12Volt VRLA, 26 Ah, 40 Numbers or as per standard Nos to provide 30 Minutes Backup in total for 10 kVA UPS at 0.8PF and ECV=1.7V. | | | | |
| | | Fully rated Inbuilt static switch at the inverter output and 100% rated Inbuilt static switch at the static bypass line integrated in UPS module. | | | | |
| | | Supply of Local Accessories (like Cabling Between UPS and the Battery onsidering Cable Routing ,Battery Interlinks ,Battery Rack etc). | | | | |
| | | Backfeed protection at Mains & Bypass (Inbuilt / External). | | | | |
| | | Installation and Commissioning of 10 kVA UPS, Battery and Accessories. | set | 1.00 | 218204.00 | 2,18,204.00 |
| 40.02 | MR 35 | Supply , installation , testing and commissioning 63A FP MCB of 10kA breaking Capacity in metal sheet enclosure with ON/OFF, TYB Indication lamps for Incoming of UPS Complete in All Respect as Required. | set | 2.00 | 3459.00 | 6,918.00 |
| | | Total of sub-head (40.0) (Non DSR) | | | | 2,25,122.00 |
| 41.0 | MR 36 | Lightening Arrester System For Transformer | | | | |
| | | Supply, Installation, Testing & Commissioning of Lightening Arrester HT-12 kV expulsion type complete with all Fitting transission class discharge capacity 10 kA complete all as as specified | Each | 3.00 | 4007.00 | 12,021.00 |
| | | Total of sub-head (41.0) (Non DSR) | | | | 12,021.00 |
| 42.0 | | Pumps (Non Scheduled Items) | | | | |
| 42.01 | MR | Borewell Submersible Pump | Set | 2.00 | 55420.00 | 1,10,840.00 |
| | | Supplying & Installation of suitable borewell submersible pump set coupled with 6" motor and complete with lowering in existing borewell with the help of chain pulley block including supplying and fixing motor starter suitable for the selected pump complete as required.(Note : The suction/delievery pipe lines are not included in this item) | | | | |
| | | Flow Rate : 350 to 400 LPM | | | | |
| | | min. Head : 60 M | | | | |
| | | Min. Motor HP : 7.5 H.P. | | | | |
| 42.02 | MR | Supplying and Fixing of PVC covered 6 mm dia flexible steel rope for handling/protecting the submersible Pump set including U-lock arrangement etc. complete as required. | Metre | 300.00 | 55.00 | 16,500.00 |
| 42.03 | MR | Supplying and Fixing of suitable size of MS clamp set suitable for holding submersible pump & 40 mm dia pipe assembly lowered in bore well including suitable drilled hole and nut bolts etc. complete as required. | Each | 4.00 | 735.00 | 2,940.00 |
| 42.04 | MR | Supplying and Fixing of following size of PVC insulated PVC sheathed Copper conductor flat submersible cable including fixing the cable with nylon tie along with GI pipes in existing borewell, connection with submersible pump cable with the help of water proof jointing kit provided with the pump, complete as required. (a) 3 x 2.5 sqmm | Metre | 290.00 | 115.00 | 33,350.00 |
| | | S/Fixing of 8 " dia MS cover with locking arrangement i/c drilling hole and s/f nut bolts etc. complete as reqd. | | 2.00 | 1040.00 | 2,080.00 |
| 42.05 | MR | Openwell Submersible Monobloc Pump Set | Set | 2.00 | 51240.00 | 1,02,480.00 |

| S. No. | DSR 2019 | Description | Unit | Quantity | Rate (In Rs) | Amount (In Rs) |
|--------|----------|---|-------|----------|--------------|--------------------|
| | | S.I.T.C. of 7.5/5.5 (H.P./Kw) Openwell Submersible Monobloc Pump Set comprising of Electrical Driven inline pumping with all accessories as per manufacturer's design. such as C.I. Base, S.S/bronze impeller, shaft, mechanical seal, S.S. Shaft directly coupled to motor suitable for operation on 400/440 volts, 3 phase 50c/s A.C.Supply complete in the existing G.I.Pipelines fittings/c s/fixing motor starter suitable for this pump set i/c connections testing, commissioning etc as reqd. (Note : The suction/delivery pipe lines are not included in this item) | | | | |
| | | Flow Rate : 4.5 to 5.0 LPS | | | | |
| | | Min. Head : 50 M | | | | |
| | | Min. Motor HP : 7.5 H.P. (Each) | | | | |
| | | Total of sub-head (42.0) (Non DSR) | | | | 2,68,190.00 |
| 43 | | CCTV SYSTEM | | | | |
| 43.01 | 1.53 | Supplying and drawing of UTP 4 pair CAT 6 LAN Cable in the existing surface/ recessed Steel/ PVC conduit as required. | | | | |
| | 1.53.1 | 1 run of cable | Mtr. | 1630.00 | 49.00 | 79,870.00 |
| 43.02 | 1.21 | Supply and fixing of following sizes of medium class PVC conduit along with accessories in surface/recess including cutting the wall and making good the same in case of recessed conduit as required : | | | | |
| | 1.21.2 | 25 mm | Mtr. | 840.00 | 90.00 | 75,600.00 |
| 43.03 | MR36 | 1/2.8" Progressive Scan CMOS, PAL:1920 * 1080, 0.1 Lux/ F1.2 (0Lux, IR ON), 10~15 Meters (With Min. 24 units IR LED), 2 MP Fixed IR DOME CAMERA With Options Of 2.8mm , 4mm , 6mm Lens , IP66 , POE with installation. (For Substation-2, Kitchen and Dining-6) | Each | 10.00 | 6488.00 | 64,880.00 |
| 43.04 | MR37 | 1/2.8" Progressive Scan CMOS, PAL:1920 * 1080, 0.1 Lux/ F1.2 (0Lux, IR ON), 10~15 Meters (With Min. 24 units IR LED), 2 MP Fixed IR Bullet CAMERA With Options Of 2.8mm , 4mm , 6mm Lens , IP66 , POE with installation. (For Main Gate-2, School-7, Boys Hostel-5, Girls Hostel-5, Kitchen & Dining-5) | Each | 26.00 | 6488.00 | 1,68,688.00 |
| 43.05 | MR38 | Supplying, installation, fixing, testing and commissioning of 16 ch Linux, H. 264 / H.265 NVR with Minimum 1080p / UXGA / 720p / VGA / 4CIF / DCIF / 2CIF / CIF / QCIF rec. resolutions, 4 HDD slot supports upto 4 TB Each, RS 485 x 1 & USB2.0 x1, HDMI ,Local And Remote Access Over Internet In complete in all respect with installation (Make: - CP PLUS , Dahua ,Hikvision or equivalent) (For School, Main Gate, Substation-1, Kitchen & Dining-1, Bosy hostel-1, Girls hostel-1) | Each | 4.00 | 28413.00 | 1,13,652.00 |
| 43.06 | MR39 | 4 TB Surveillance Sata HDD (WD Purple , Seagate Surveillance or Equivalent) | Each | 4.00 | 10526.00 | 42,104.00 |
| 43.07 | MR40 | 16 Port POE Switch (Cisco , Netgear , Dlink or Equivalent) | Each | 4.00 | 17716.00 | 70,864.00 |
| 43.08 | MR41 | Supply, installation, testing and commissioning of Independent 1 kVA UPS system with 230V single phase input and 230V Single phase output with all required accessories & battery bank for 30 mins back up with covered SMF battery and battery rack for all new required loads covered as required, including connections as per specifications etc. complete as required. (for Server and CCTV - Boyshostel-1, Girls hostel-1, Kitchen & Dining-1). | Each | 3.00 | 28899.00 | 86,697.00 |
| | MR42 | S.I.T.C.32" Color flat panel LED Monitor,Full HD Professional Series 1920 x 1080 resolution, inputs. 100-230VAC/50 Hz. | Each | 1.00 | 21743.00 | 21,743.00 |
| | | Total of sub-head (43.0) (DSR) | | | | 1,55,470.00 |
| | | Total of sub-head (43.0) (Non DSR) | | | | 5,68,628.00 |
| 44 | | LIGHTNING CONDUCTOR | | | | |
| 44.01 | 6.2 | Providing and fixing of lightning conductor finial, made of 25mm dia 300mm long, G.I tube, having single prong at top with 85mm dia 6mm thick G.I base plate including holes etc. complete as required. | Each | 50.00 | 448.00 | 22,400.00 |
| 44.02 | 6.7 | Providing and fixing G.I tape 20 mm x 3 mm thick on parapet or surface of wall for lightning conductor complete as required. (for horizontal run) | Mtrs. | 1570.00 | 104.00 | 1,63,280.00 |
| 44.03 | 6.8 | Providing and fixing G.I tape 20 mm x 3 mm thick on parapet or surface of wall for lightning conductor complete as required. (for vertical run) | Mtrs. | 435.00 | 163.00 | 70,905.00 |

| S. No. | DSR 2019 | Description | Unit | Quantity | Rate (In Rs) | Amount (In Rs) |
|---------------------------------------|----------|---|------|----------|--------------|--------------------|
| 44.04 | 6.4 | Jointing copper / G.I. tape (with another copper/ G I tape, base of the finial or any other metallic object) by riveting / nut bolting/ sweating and soldering etc as required. | Each | 111.00 | 93.00 | 10,323.00 |
| 44.05 | 6.12 | Providing and fixing testing joint, made of 20 mm X 3 mm thick G.I. strip, 125 mm long, with 4 nos. of G.I. bolts, nuts, chuck nuts and spring washers etc. complete as required. | Each | 22.00 | 102.00 | 2,244.00 |
| 44.06 | 5.4 | Earthing with G.I. earth plate 600mm x 600mm x 6mm thick including accessories, and providing masonry enclosure with cover plate having locking arrangement and watering pipe of 2.7Mtr long etc. with charcoal/ coke and salt as required. | Set. | 22.00 | 6216.00 | 1,36,752.00 |
| Total of sub-head (44.0) (DSR) | | | | | | 4,05,904.00 |
| 45.00 | | D.G.Set and associated works | | | | |
| 45.01 | MR 1 | D.G.Set 62.5 KVA | | | | |
| | | Providing, Installing, Testing and Commissioning of 'Silent Type' Diesel Generating set alongwith having Prime Power Rating of 62.5 KVA, 415 volts at 1500 RPM, 0.8 lagging power factor at 415 V suitable for 50 Hz, 3 phase system & for 0.85 Load Factor and consisting of the followings | | | | |
| | (a) | Diesel Engine: | | | | |
| | | Diesel engine 4 stroke water cooled, electric start, of suitable BHP at 1500 RPM suitable for above output of alternator at 40 Degree C, 50% RH & at 1000 Meter MSL and conforming to BS 5514, BS 649, IS 10000, capable of taking 10% over loading for one hour after 12 hours of continuous operation. The engine will be fitted complete with all the required accessories. | | | | |
| | (b) | Engine mounted Instrument Panel fitted with and having digital display for following: | | | | |
| | | (i) Start-stop switch with key | | | | |
| | | (ii) Water temperature indication | | | | |
| | | (iii) Lubrication oil pressure indication | | | | |
| | | (iv) Lubrication oil temperature indication | | | | |
| | | (v) Battery charging indication | | | | |
| | | (vi) RPM indication | | | | |
| | | (vii) Over speed indication | | | | |
| | | (viii) Low lub. Oil trip indication | | | | |
| | | (ix) Engine Hours indication | | | | |
| | (c) | Alternator : | | | | |
| | | Synchronous alternator rated at 62.5 KVA, 415 volts at 1500 RPM, 3 phase 50 Hz, AC supply with 0.8 lagging power factor at 40 Degree C, 50% RH & at 1000 Meter MSL. The alternator shall be having SPDP enclosure, brushless, continuous duty, self-excited and self-regulated through AVR conforming to IS: 4722/BS 2613 suitable for tropical conditions and with class- F/H insulation | | | | |
| | (d) | Base Frame & Foundation: | | | | |
| | | Both the engine and alternator shall be mounted on suitable base frame made of MS channel with necessary reinforcement which shall be installed on suitable cement concrete foundation and vibration isolation arrangement as per recommendations of manufacturer. | | | | |
| | (e) | Fuel Tank: | | | | |
| | | Daily service fuel tank of 120 liters capacity fabricated out of 3 mm thick M.S. sheet complete with all standard accessories and fuel piping between fuel tank and diesel engine with MS class 'C' pipes of suitable dia. Complete with valves, level indications & accessories as required as per specifications. | | | | |
| | (f) | Exhaust System: | | | | |
| | | Dry exhaust manifold with hospital exhaust silencer and catalytic convertor. | | | | |
| | (g) | Starting System: | | | | |
| | | 12V/24V DC starting system comprising of starter motors: voltage regulator and arrangement for initial excitation complete with suitable nos. of batteries (25 plates, 180 Amp. Hour capacity lead acid type) as required as per specifications. | | | | |
| | (h) | Accoustic and weather proof enclosure with arrangement for fresh air intake for cooling of the engine & alternator, extraction, discharging hot air in to the atmosphere as per specifications. | | 1.00 | 594200.00 | 5,94,200.00 |
| 45.02 | MR 2 | AMF system for 62.5 KVA DG Set Part of DG. | | | | |
| | | Fabricating, Installing, Testing & Commissioning of automatic mains failure control including auto by-pass panel, suitable for 62.5 KVA silent type DG set complete with relays, timers, set of CTs for metering & protection and energy analyser to indicate currents, phase and line voltages, frequency, power factor, KWH, KVARH & provision for overload, short circuit, restricted earth fault, under frequency, control cabling from AMF panel to diesel engine and elsewhere if required, all complete and inter locking including the following: | | | | |
| | (a) | (i) 1 No. 125 415V, 4P MCCB of 35kA. | | | | |

| S. No. | DSR 2019 | Description | Unit | Quantity | Rate (In Rs) | Amount (In Rs) |
|--------|----------|--|------|----------|--------------|------------------------|
| | | (ii) 2 Nos. 125A, 415V 4P Contactor | | | | |
| | | (b) Auto/Manual/Test/Off selector switch | | | | |
| | | (c) 2 Nos over voltage relay, 2 Nos reverse power relay and 2 Nos under voltage relay. | | | | |
| | | (d) 3 Sets of current transformers 15 P 10 accuracy for protection and 15 VA class-I for metering | | | | |
| | | (e) Energy analyser unit to indicate current voltage frequency power factor and KWH | | | | |
| | | (f) Indicating lamps for load on mains and load on set | | | | |
| | | (g) Fuse for instruments | | | | |
| | | (h) Battery charger, complete with transformer/ rectifier, D.C. voltmeter and ammeter, selector switch for trickle, off and boost and current adjustment. | | | | |
| | | (i) Main supply failure monitor | | | | |
| | | (j) Supply failure timer | | | | |
| | | (k) Restoration timer | | | | |
| | | (l) Control unit with three impulse automatic engine start/stop and failure to start lockout. | | | | |
| | | (m) Impulse counter with locking and reset facility. | | | | |
| | | (n) ON/OFF/Control circuit switch with indicator | | | | |
| | | (o) Audio/Video annunciation for | | | | |
| | | (i) High water temperature | | | | |
| | | (ii) Low lubricating oil pressure | | | | |
| | | (iii) Engine over speed | | | | |
| | | (iv) Engine fails to start | | | | |
| | | (v) Full load/maximum load warning | | 1.00 | 129500.00 | 1,29,500.00 |
| 45.03 | MR 3 | Supplying and fixing exhaust gas piping of 75mm dia. welded black MS, B Class pipe conforming to IS:3589 cut to required lengths and installed with necessary bends, supports and clamps, anti-vibration mountings, insulation of exhaust system with mineral wool/Rockwool, 50 mm thick wiremesh & aluminum cladding etc., as required as per specifications. | | 4.00 | 1280.00 | 5,120.00 |
| | | Total of sub-head (45.0) (Non DSR) | | | | 7,28,820.00 |
| X | | Total Cost Including 12% GST | | | | 32,65,28,626.46 |
| Y | | Total Cost Including 18% GST (Multiplying factor of 1.0633 on X) as per CPWD circular dt. 10-08-2022 | | | | 34,71,97,888.52 |
| Z | | Total Cost Excluding 18% GST (Y/1.18) | | | | 29,42,35,498.75 |